









Acrel Co.,Ltd

Jennifer Liu /Sales Manager

-  +86 18321766360
-  jennifer@acrel.cn
-  +86 18321766360
-  +86 18321766360
-  jennifer@acrel.cn
-  No.253 Yulv Road, Jiading, Shanghai,China



WeChat



WhatsApp



2022.09



M I C R O - G R I D S Y S T E M

S O L U T I O N S



[Stock Code: 300286.SZ]

Solutions For Enterprise

Micro-grid System



ACREL CO.,LTD.

BRIEF INTRODUCTION

Company Profile

Acrel Co., Ltd. [Stock Code : 300286. SZ] is a high-tech enterprise concentrating on research, production, sales and services. It mainly provides systemic solutions of energy efficiency management and electrical safety for users. 'Acrel' is equipped with the complete production lines from cloud platform software to sensors. Until now, it has more than 8000 sets systemic solutions used in China to help users to realize energy visual management ,supply energy data services and improve electrical efficiency and safety. 'Acrel' has maintained steady growth since its listing in 2012. The company will adhere to the concept of 'innovation,high-efficiency,unity and honesty' and it provides more high-quality solutions,products and service for power system users and micro-grid.

CONTENTS

Cloud Platform

I

1. Operation and Maintenance Cloud Platform for Substations	01
2. Prepayment Cloud Platform	03
3. IoT based Energy Management System	06
4. Energy Management Cloud Platform	12

Solutions

II

1. Split Core Current Transformer	15
2. Hall Effect Current Sensor	20
3. Smart Motor Control and Protection Solution	23
4. Temperature and Humidity Measurement Solution	25
5. Power Monitoring System	28
6. Wireless Temperature Monitoring System	31
7. Residual Current Operated Relay	34
8. Energy Management System	37
9. Prepaid Solution	40
10. Photovoltaic System Solutions	42
11. Smart Busway Monitoring Solution	45
12. Precision Distribution Monitoring Solution for IDC	47
13. Energy Consumption Monitoring Solution for Base Station	50
14. Charging Pile Energy Management System Solution	51

Equipment Sets

III

1. ANSVG Static Var Generator	54
2. ANAPF Active Power Filter	56

Monitoring Device

IV

1. Power Sensor	
1) AKH-0.66 Series Measurement Current Transformer	58
2) AHKC Series Hall Sensor	65
3) BA Series Electrical Transducer	74

CONTENTS

Monitoring Device

IV

4) BD Series Electrical Transducer	78
5) BM Series Analog Signal Isolator	82
2. Power Monitoring and Controlling	
1) AMC Series Programmable Power Meter	87
2) PZ Series DC Power Analyzer	95
3) ARTU Series Unit	97
4) ARD Series Smart Motor Protector	103
5) WHD Series Temperature&Humidity Controller	114
6) AM Series Protection Relay	117
7) ARTM Series Temperature Monitor	170
8) ASJ Series Power Relay	175
3. Energy Management	
1) APM Series Multifunction Meter	180
2) ADL Series Din Rail Energy Meter	184
3) ADL Series Prepayment Meter	191
4) ADF Series Multi-circuits Energy Meter	192
5) ADW Series IoT Power Mete	196
6) DJSF Series DC Energy Meter	203
4. New Energy	
1) AGF-AE Series PV/Solar Inverter Energy Meter	206
2) AGF Series Solar String Monitoring Device	207
3) ACR10R-D Series PV/Solar Inverter Energy Meter	209
5. Smart Gateway	
1) AWT100 Series Wireless Communication Terminal	214
2) ANet Series Smart Gateway	216
6. Data Center/Tower/Base Station	
1) AMC Series Data Center Monitor Module	220
2) DTSD Series Multi-Circuits Energy Meter	263
3) ADW350W Series IoT Energy Meter	266
4) AMC Series Multi-Circuits DC Energy Meter	269
5) AMB Busway Monitoring Meter	272

Cloud Platform

Operation and Maintenance Cloud Platform for Substations

➤ 1.Application

- Factory
- Hospital
- University
- Community
- Commercial&Complex

➤ 2.Structure

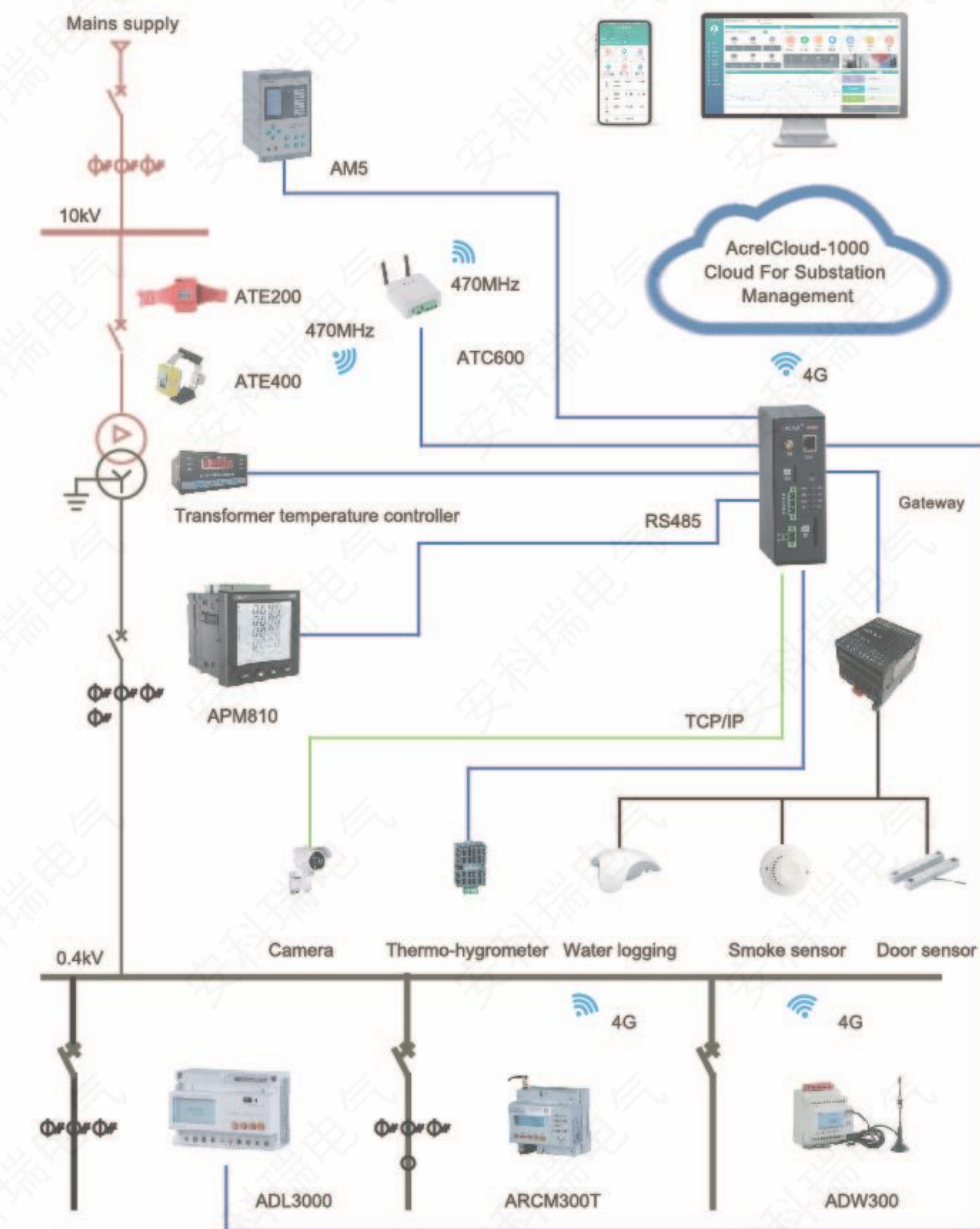

➤ 3.Main Functions

Cloud-enabled Monitoring Service

Monitoring electrical parameters such as voltage, current, power, frequency, harmonics and three-phase imbalance, cable and bus temperature.



Fault Alarm

Platform can send all kinds of alarm information (such as overvoltage, undervoltage, overcurrent, smoke, switch trip) to users by SMS/Email/APP.



Energy Efficiency Analysis

Platform can provide hourly, daily, monthly, and annual power consumption report according to the distribution circuit, area, department, and sub-item (lighting, air conditioning, power, etc.).



Equipment Management

Set and update equipment archives of transformers, inlet cabinets, outlet cabinets, measuring cabinets, high-voltage cables, etc. Recording the installation and repair information of these equipment to realize life cycle management.

ID	Name	Type	Spec	Brand	Location	Status	Inst. Date	Exp. Date	Remarks
001	10kV Transformer	Transformer	1000kVA	ABB	110kV Substation	Normal	2018-01-01	2023-01-01	
002	10kV Inlet Cabinet	Cabinet	10kV	ABB	110kV Substation	Normal	2018-01-01	2023-01-01	
003	10kV Outlet Cabinet	Cabinet	10kV	ABB	110kV Substation	Normal	2018-01-01	2023-01-01	
004	10kV Measuring Cabinet	Cabinet	10kV	ABB	110kV Substation	Normal	2018-01-01	2023-01-01	
005	10kV High-voltage Cable	Cable	10kV	ABB	110kV Substation	Normal	2018-01-01	2023-01-01	

Inspection and Repair Management

The platform can prepare the tasks and send it to the mobile of the engineer. By App, engineer performs the tasks and record the defects at the substation site.



User Report

Automatically summarizes the operation data of the substation for one month and lists various defects found during the inspection.

App Access

By App, users can realize the functions of video monitoring, power parameter query, energy analysis, alarms receiving, inspections and defects recording.



Prepayment Cloud Platform

➤ 1.Application

- 📁 Chain Stores
- 📁 Chain Hotels
- 📁 Properties
- 📁 University Dormitories
- 📁 Intelligent Communities

2. Structure

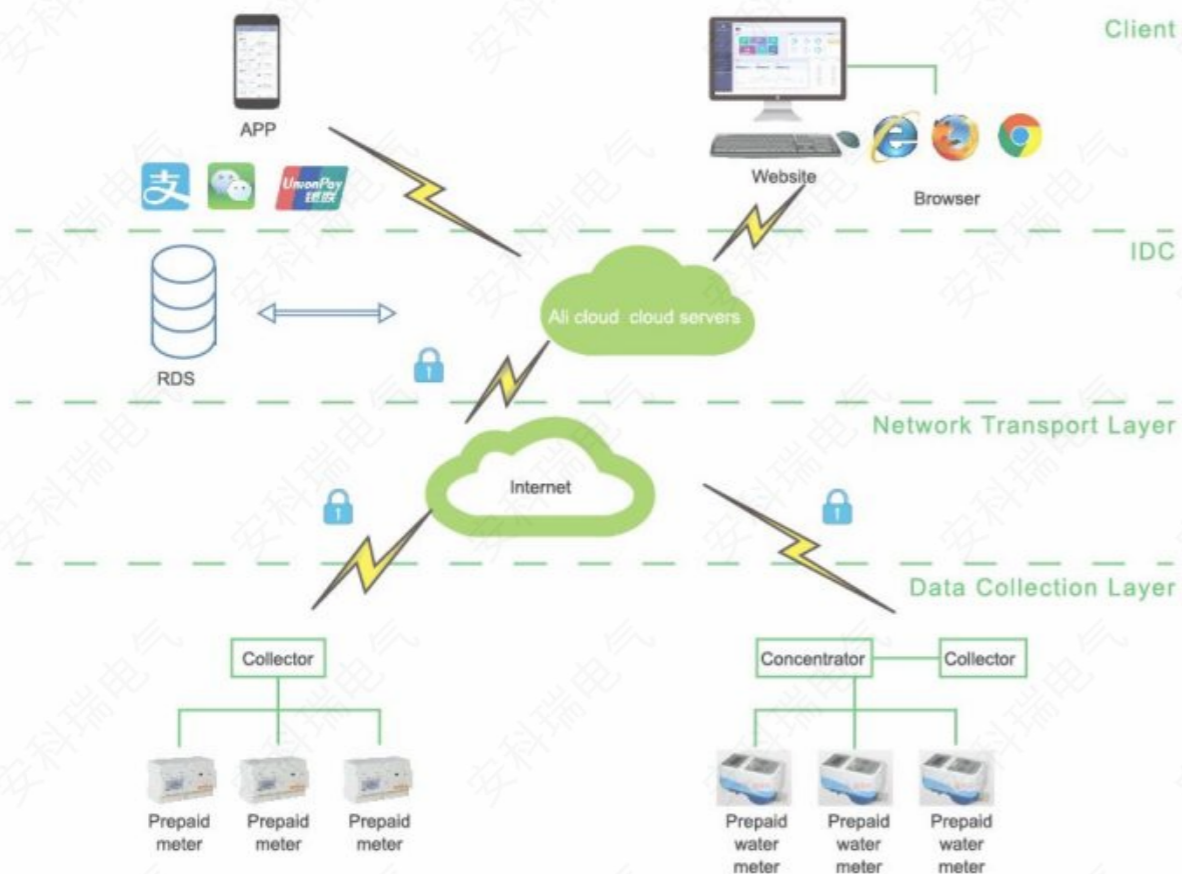

3. Main Functions

Remote Data Monitoring, Remote Deposit

The data is uploaded to the cloud platform in real-time through gateway, unit price can be set on each electricity meter or water meter.



Cloud Deployment

Software installation, upgrade and maintenance are easy.

Balance Warning

When the balance is insufficient, the system will remind the users to recharge in time by SMS or E-mail.

Remote Control

According to the management requirements, the user can control the electricity meter and water meter within his authority. For example, control the power switch and water meter valve, set the price and the alarm parameters, etc.

Energy Report

The system can provide various reports, such as energy consumption report and financial report, etc.

Online Payment

The users can check balance and recharge online.

Third Party Interface API

The system can provide interface(API or SDK) for a third-party platform.

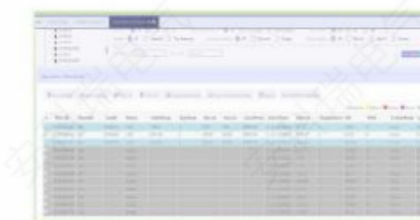

Application in Dormitories

The system can support dormitory management, such as timing control, unsafe load identification, ect.

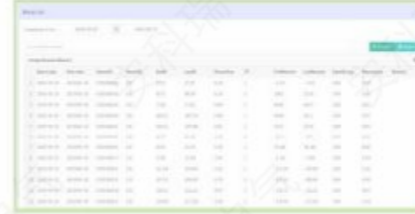

Historical Record and Report

All alarm information, remote control and recharge operation are recorded in the logs for users to query.

4.Product Selection

No.	Name	Specifications
1	Smart gateway	ANet-2E8S1 2* 10M/100M RJ45 8*RS485 1*4G
2	Smart gateway	AF-GSM400-4GY 1*RS485 1*4G 24V DC power supply
3	Three-phase prepaid meter	ADL300-EY
4	Single-phase prepaid meter	ADL100-EY
5	Multi-circuit prepaid meter	ADF400L
6	Switching power supply	KDYA-DG30-24K output DC 24V
7	Data acquisition box	400mm*500mm*200mm

IoT based Energy Management System

1.Application

- ✎ Substation
- ✎ Industrial energy consumption
- ✎ Building
- ✎ Intelligent lighthouse
- ✎ Telecommunication base station
- ✎ Operation and maintenance of power

2.Your Benefits



3.Structure

3.1 Cloud IoT Solution Structure

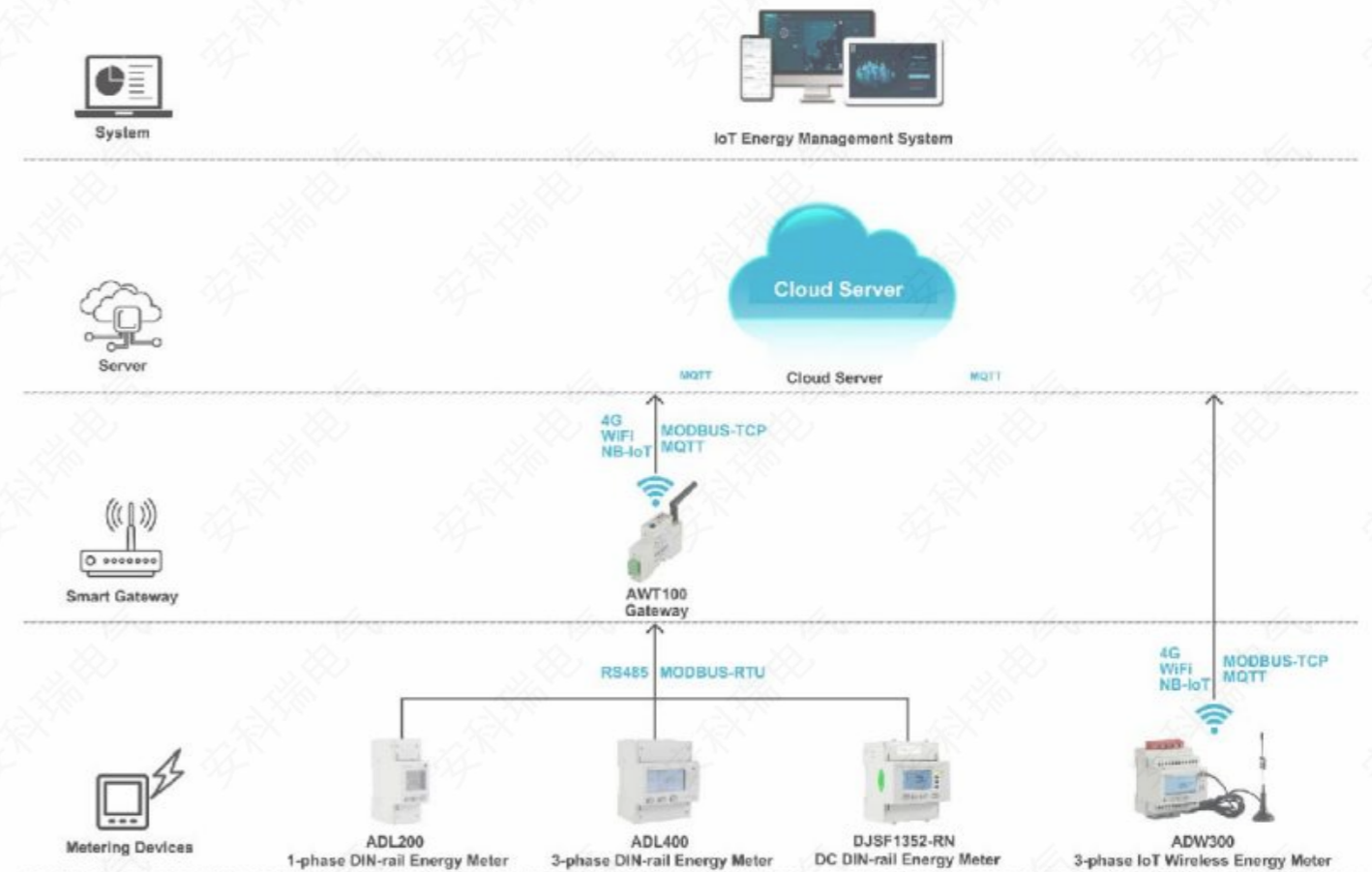

3.2 Local IoT Solution Structure

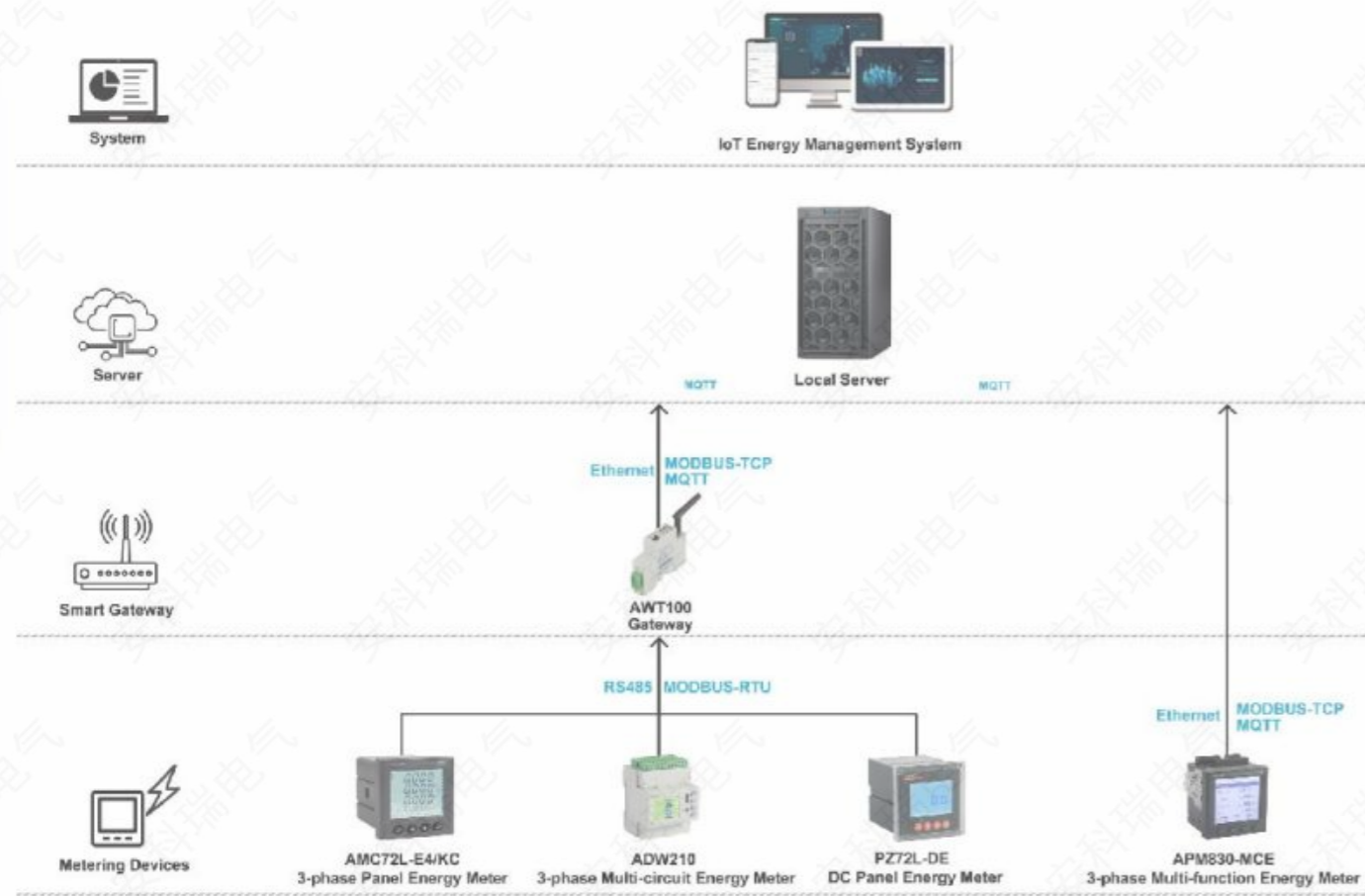

4. Main Functions

Alarm Analysis

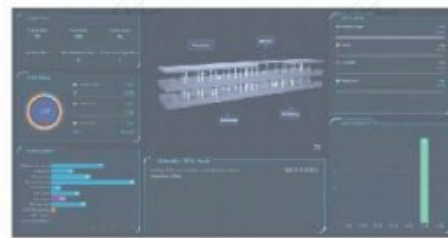

Energy situation



Details of electrical parameters



Equipment status



5. Our Offering



IoT WEB Platform

IoT WEB Platform

IoT WCD Platform is the website mainly designed for PC users based on the IoT Smart Metering System. All function of IoT Energy Management System can be realized in this Platform like checking power consumption data, exporting energy report and etc.

[Explore More](#)



IoT Mobile APP

IoT Mobile APP is the APP mainly designed for mobile phone users based on the IoT Smart Metering System. All function of IoT Energy Management System can be realized in this APP like checking power consumption data, exporting energy report and etc.

[Explore More](#)



Smart Energy Meters

Smart energy meters with either standard RS485 (MODBUS-RTU) protocol to be paired with IoT gateways for IoT communication network or built-in wireless communication like 4G, WiFi, LoRa and etc for setting up IoT communication network without the aid of IoT gateways.

[Explore More](#)



IoT Gateways

IoT gateways with upstream of 4G, WiFi, LoRa, LoRaWAN, Ethernet and downstream of RS485(MODBUS-RTU), LoRa to be paired with smart energy meters with RS485 or LoRa communication for setting up the IoT communication network.

[Explore More](#)

6. Get Started



Step 1: Confirm Request

Contact us for discussing about your request and some technical specs so that we can customize a solution and select the most compatible products for you.



Step 2: Get Quotation

Get a quotation from us and evaluate your cost and benefits. We have freight forwarder for world wide shipment and support 1 MOQ.



Step 3: Sample Order Test

Order small quantity of our products for testing, we will assist you with full technical support for both installation and adjustment remotely.



Step 4: Mass Production

Once the products worked normally as your request, it's time for processing mass order and production to fulfill your total request.

7. Product Selection

Usage	Basic Model	Function&Description
IoT Gateway	AWT100	Upstream: 4G/WiFi/NB-IoT/Ethernet/LoRa (Optional); Downstream: RS485 (MODBUS-RTU)
	ANet	Upstream: 4G; Downstream: 2-channel RS485 (MODBUS-RTU)
IoT Energy Meter (DIN-rail Installed)	ADW300	Monitoring: Up to 1 AC Circuit 3-phase; Wireless Communication:4G/WiFi/NB-IoT/LoRa; Rated Voltage: Up to 660Vac L-L; Rated Current: 3x1(6)AAC (via CTs); Measurement: 3-phase Active Power, Reactive Power, Current, Voltage, Harmonic and etc.
	ADW2xx	Monitoring: Up to 4 AC Circuit 3-phase; Communication:Lora/RS485 (MODBUS-RTU) Rated Voltage: 380~456Vac L-L&220~264Vac L-N; Rated Current: 3x1(6)AAC (via CTs); Measurement: 3-phase Active Power, Reactive Power, Current, Voltage, Harmonic and etc.
	ADL200	Monitoring: Up to 1 AC Circuit 1-phase; Communication:RS485 (MODBUS-RTU) Rated Voltage: 220~264Vac L-N; Rated Current: 10(80)AAC (via direct connect); Measurement: 1-phase Active Power, Reactive Power, Current, Voltage and etc.
	ADL400	Monitoring: Up to 1 AC Circuit 3-phase; Communication:RS485 (MODBUS-RTU); Rated Voltage: 380~456Vac L-L&220~264Vac L-N; Rated Current: 3x1(6)AAC or 3x10(80)AAC Measurement: 3-phase Active Power, Reactive Power, Current, Voltage, Harmonic and etc.

Usage	Basic Model	Function&Description
IoT Energy Meter (DIN-rail Installed)	DJSF1352-RN	Monitoring: Up to 1 DC Circuit; Communication:RS485 (MODBUS-RTU); Rated Voltage: Up to 1000Vdc; Rated Current: 4~20mA (via Hall Sensor)&75mV(via Shunt); Measurement: kWh, kVarh, Power, Current, Voltage and etc.
IoT Energy Meter (Panel Mounted)	APM8xx	Monitoring: Up to 1 AC Circuit 3-phase; Communication: Ethernet&RS485 (MODBUS-TCP&RTU) Rated Voltage: Up to 690Vac L-L; Rated Current: 3x1(6)AAC (via CTs); Power Quality: 2nd~63rd Harmonic; Cosφ, Current&Voltage Unbalance; Waveform and etc Measurement: 3-phase Active Power, Reactive Power, Current, Voltage and etc.
	AMC72L-E4/KC	Monitoring: Up to 1 AC Circuit 3-phase; Communication:RS485 (MODBUS-RTU); Rated Voltage: 380~456Vac L-L&220~264Vac L-N; Rated Current: 3x1(6)AAC (via CTs); Measurement: 3-phase Active Power, Reactive Power, Current, Voltage, Harmonic and etc.
	AMC96L-E4/KC	Monitoring: Up to 1 AC Circuit 3-phase; Communication:RS485 (MODBUS-RTU); Rated Voltage: 380~456Vac L-L&220~264Vac L-N; Rated Current: 3x1(6)AAC (via CTs); Measurement: 3-phase Active Power, Reactive Power, Current, Voltage, Harmonic and etc.
	PZ72L-DE	Monitoring: Up to 1 DC Circuit; Communication:RS485 (MODBUS-RTU); Rated Voltage: Up to 1000Vdc; Rated Current: 4~20mA (via Hall Sensor)&75mV(via Shunt); Measurement: kWh, kVarh, Power, Current, Voltage and etc.
Split-core CT	AKH-0.66/K	Primary Current Input: Up to 5000AAC; Secondary Current Output: 5A or 1AAC;
	AKH-0.66/K K-φ	Primary Current Input: Up to 1000AAC; Secondary Current Output: 5A or 1AAC;
Solid-core CT	AKH-0.66/I	Primary Current Input: Up to 6300AAC; Secondary Current Output: 5A or 1AAC;

Energy Management Cloud Platform

1. Application

- Commercial Building
- Office Building
- Culture Center
- Tourist Architecture
- Telecommunication Building
- Road-Traffic Project

2. Your Benefits

Reduce Energy Bill

Cut Off Energy Waste

Lower Your OPEX

Protect Your Property

Be more Eco-friendly

3. Structure

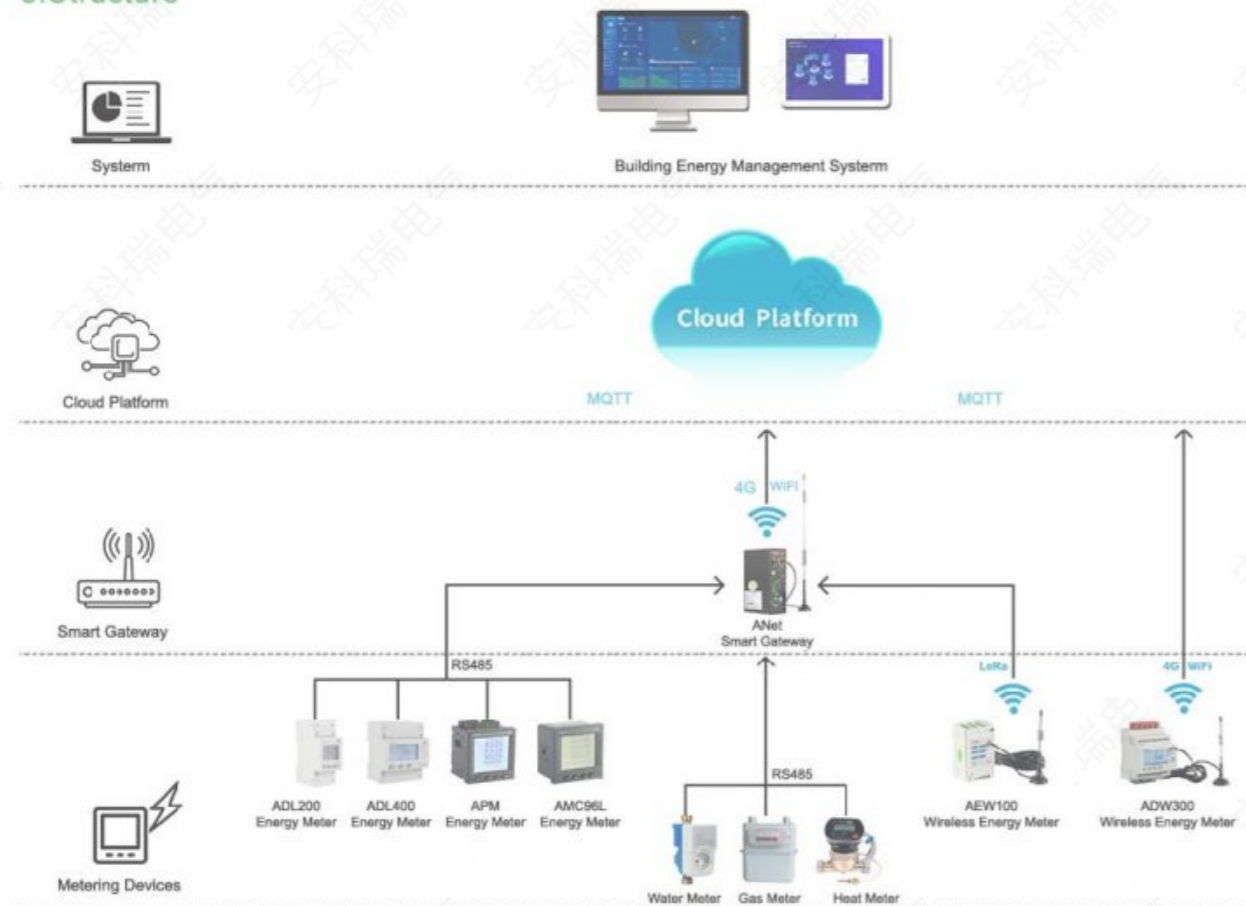

4. Main Functions

Energy Analysis

Providing year-on-year and period-on period energy analysis based on accurate data collect by smart meters. Find out potential waste and reduce your energy bill based on real-time data.



Energy Report

An one-click auto-generated energy report to optimize your energy saving plan and visualize your financial report of power consumption for monitoring the energy usage of different departments or regions.



Eco Analysis

A chain-analysis between energy consumption and potential cost of coal or emission of CO2. Be more eco-friendly for a better world.



Remote Monitor

By creating IoT network by using IoT gateways and smart meters from our company, can we realized a real-time remote data monitoring just sitting in your office on the computer or your mobile phone.



5. Our Offering



Building EMS WEB

EMS WEB Platform is the website mainly designed for PC users based on the IoT Smart Metering System. All function of IoT Smart Metering System can be realized in this Platform like checking power consumption data, exporting energy report and etc.

[Explore More](#)



Building EMS APP

EMS Mobile APP is the APP mainly designed for mobile phone users based on the IoT Smart Metering System. All function of IoT Smart Metering System can be realized in this APP like checking power consumption data, exporting energy report and etc.

[Explore More](#)



Smart Energy Meters

Smart energy meters with either standard RS485 (MODBUS-RTU) protocol to be paired with IoT gateways for IoT communication network or built-in wireless communication like 4G, WiFi, LoRa and etc for setting up IoT communication network without the aim of IoT gateways.

[Explore More](#)



IoT Gateways

IoT gateways with upstream of 4G, WiFi, LoRa, LoRaWAN, Ethernet and downstream of RS485(MODBUS-RTU), LoRa to be paired with smart energy meters with RS485 or LoRa communication for setting up the IoT communication network.

[Explore More](#)

6. Quick Index

Index	Name	Type	Specification
Pg. 37~39	Energy Management System	Building EMS WEB	Designed for PC users for convient energy mangement
Pg. 216~219	Smart Gateway	ANet	Upstream of 4G, WiFi, Ethernet and etc.
Pg. 188	1-phase Energy Meter	ADL200	80A max direct load, RS485 (MODBUS-RTU)
Pg. 189~190	3-phase Energy Meter	ADL400	Direct access or CT operated, RS485 (MODBUS-RTU)
Pg. 201~203	3-phase IoT Energy Meter	ADW300	Built-in 4G, WiFi, LoRa wireless communication
Pg. 180~183	High-Class Panel Meter	APM8xx	0.2s accuracy class and multi-function expanded module
Pg. 91~93	3-phase Panel Meter	AMC96L-E4/KC	Economic multi-function panel meter, 96mm*96mm

Solutions

Split Core Current Transformer

1. Application

- ◆ Electricity renovation project: semiconductor, tyre, rubber, polycrystalline silicon
- ◆ Low voltage distribution system
- ◆ Power operations
- ◆ Data center

2. Structure

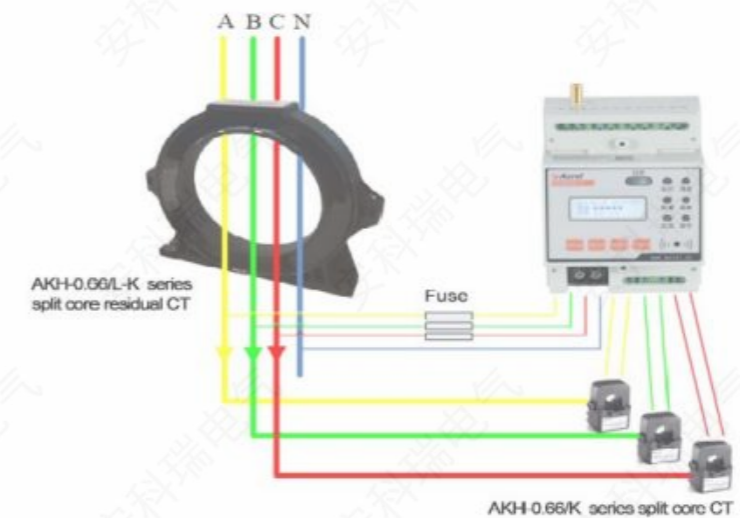
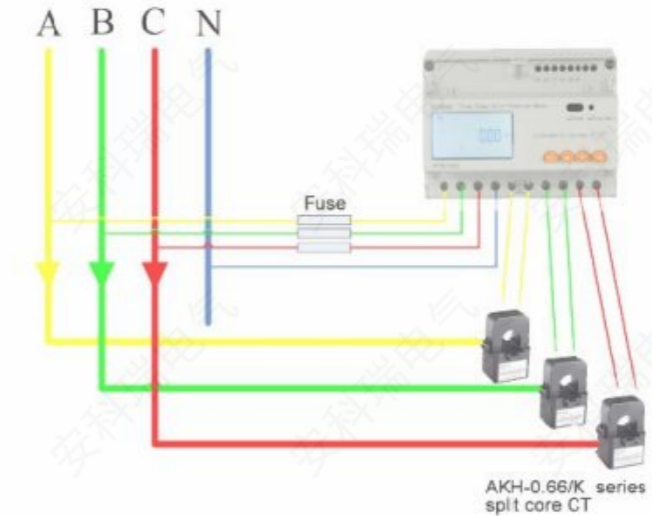

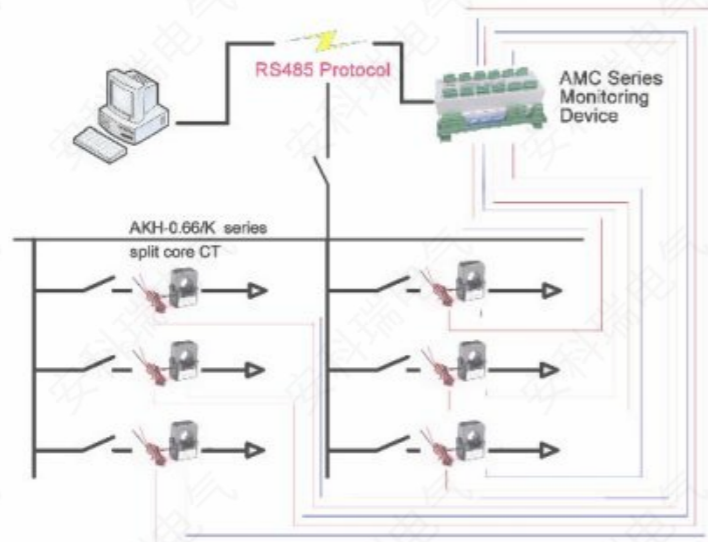
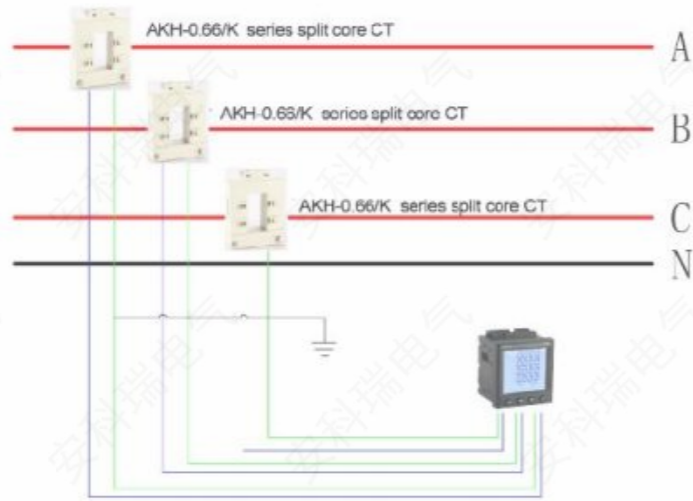

3. Advantage

- ◆ Small size
- ◆ High precision
- ◆ High capacity
- ◆ Easy installation

4. Product selection

Type	Dimension (mm)					Dia.(mm)		Error (mm)
	W	H	D	M	N	Φ1	Φ2	
K-Φ10	27	44	32	25	36	10	9	±1

Type	Dimension (mm)					Dia.(mm)		Error (mm)
	W	H	D	M	N	Φ1	Φ2	
K-Φ16	31	50	36	27	42	16	17	±1
K-Φ24	39	70.5	55	36	52	24.5	23	
K-Φ36	42	81.5	66	40	55.5	33	35	
K-Φ24	39	70.5	55	36	52	24.5	23	±1
K-Φ36	42	81.5	66	40	55.5	33	35	
K-Φ50	46.5	110	90	54	66.5	47	52	

Type	Ratio	Class (VA/Ω)		Dia. (mm)
		0.5	1	
AKH-0.66/K-Φ10	5A/1.25mA	10		Φ10
	(10-20) A/5mA	10		Φ10
	(40-60) A/5mA	10		Φ10
AKH-0.66/K-Φ16	(20-50) A/10mA	10		Φ16
	(40-100) A/20mA	10		Φ16
AKH-0.66/K-Φ24	100A/40mA	10		Φ16
	(60-200) A/20mA	10		Φ24
	(100-250) A/40mA	10		Φ24
AKH-0.66/K-Φ36	400A/100mA	10		Φ24
	(100-200) A/10mA	10		Φ36
	(200-400) A/20mA	10		Φ36
	(300-600) A/100mA	10		Φ36
AKH-0.66/K-Φ24	400A/40mA	10		Φ36
	600A/75mA	10		Φ36
	(150-200)A/5(1)A		1	Φ24
(250-300)A/5(1)A		1.5		
AKH-0.66/K-Φ36	(300-400)A/5(1)A		1.5	Φ36
	(500-600)A/5(1)A	1.5		
AKH-0.66/K-Φ50	(600-700)A/5(1)A	2.5		Φ50
	(800-900)A/5(1)A	5		
	1000A/5(1)A	10		

Type	Dimension (mm)			Dia.(mm)		Error (mm)
	W	H	D	a	e	
K-30×20	90	114	40	22	32	±1
K-60×40	114	140	36	42	62	
K-80×40	122	162	40	42	82	
K-80×50	114	159	36	52	82	
K-80×80	144	159	36	82	82	
K-100×40	144	194	52	42	102	
K-120×60	164	214	52	62	122	
K-120×80	144	199	36	82	122	
K-130×40	144	224	52	42	132	
K-130×60	170	222	70	60	130	
K-140×60	164	234	52	62	142	
K-160×80	184	254	52	82	162	
K-200×80	184	294	52	82	202	

Type	Ratio (A)	Class	Burden (VA/Ω)
K-30×20	20-75/1A	1.0	0.2
	100-150/5 (1) A	1.0	1.0
	200/5 (1) A	1.0	1.5
	250-300/5 (1) A	0.5	1.5
	350-400/5 (1) A	0.5	2.5
K-60×40	250-300/5 (1) A	1	1.5
	350-450/5 (1) A	0.5	1.5
	500-800/5 (1) A	0.5	2.5
	1000-1250/5 (1) A	0.5	5
	1500-2000/5 (1) A	0.5	10
K-80×40	300-450/5 (1) A	0.5	2.5
	500-800/5 (1) A	0.5	5.0
	1000-2000/5 (1) A	0.5	10
	2500-3000/5 (1) A	0.2	10

Type	Ratio (A)	Class	Burden (VA/Ω)
K-80×80	250-300/5 (1) A	1	1.5
	400-450/5 (1) A	0.5	1.5
	500-800/5 (1) A	0.5	2.5
	1000/5 (1) A	0.5	5
K-100×40	1000-2000/5 (1) A	0.5	10
	2500-3000/5 (1) A	0.2	10
	4000-5000A/5 (1) A	0.2	15
K-120×60	400-450/5 (1) A	0.5	2.5
	500-800/5 (1) A	0.5	5.0
	1000-2000/5 (1) A	0.5	10
	2500-5000/5 (1) A	0.2	10
K-120×80	500-800/5 (1) A	0.5	2.5
	1000-1200/5 (1) A	0.5	5
	1250-1500/5 (1) A	0.5	7.5
K-130×40	1000-2000/5 (1) A	0.5	10
	2500-5000/5 (1) A	0.2	10
K-130×60	1000-2000/5 (1) A	0.5	10
	2500-5000/5 (1) A	0.2	15
K-140×60	1000-2000/5 (1) A	0.5	10
	2500-3000/5 (1) A	0.2	10
K-160×80	4000-5000/5 (1) A	0.2	15
	1000-2000/5 (1) A	0.5	10
	2500-3000/5 (1) A	0.2	10
K-200×80	4000-5000/5 (1) A	0.2	15
	1000-2000/5 (1) A	0.5	10
	2500-3000/5 (1) A	0.2	10
K-P-120×60	4000-5000/5 (1) A	0.2	15
	300-400/5 (1) A	5P10	2.5
	400/5 (1) A		2.5
500/5 (1) A	3.75		

Type	Ratio (A)	Class	Burden (VA/Ω)
K-P-120×60	600-800/5 (1) A	5P10	5.0
	1000-1250/5 (1) A		7.5
	1500-1600/5 (1) A		10
	2000-3000/5 (1) A		15
K-P-160×80	500-800/5 (1) A		2.5
	1000-1500/5 (1) A		5.0
	2000/5 (1) A		10
	2500-3000/5 (1) A		15
K-P-200×80	4000-5000/1A		20
	500-800/5 (1) A		2.5
	1000-1500/5 (1) A		5.0
	2000/5 (1) A		10
K-P-200×80	2500-3000/5 (1) A	15	
	4000-5000/5 (1) A	20	

Hall Effect Current Sensor

1. Application

- ◆ Industrial control
- ◆ Energy and Automation
- ◆ Automotive
- ◆ Railway

2. Structure

■ Photovoltaic

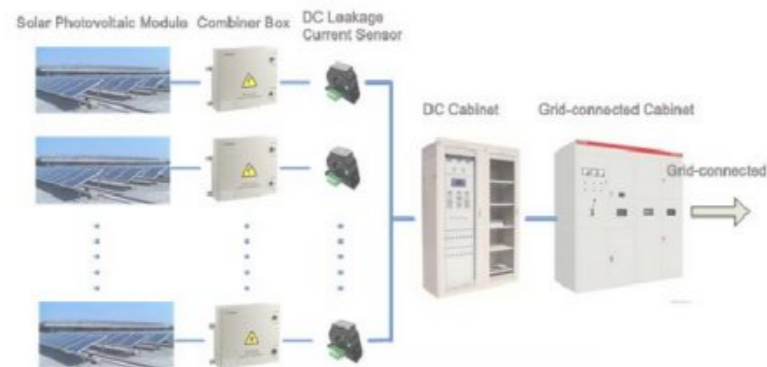

■ UPS



■ Solar and wind energy



■ Electric welding machine



■ Motor servo system

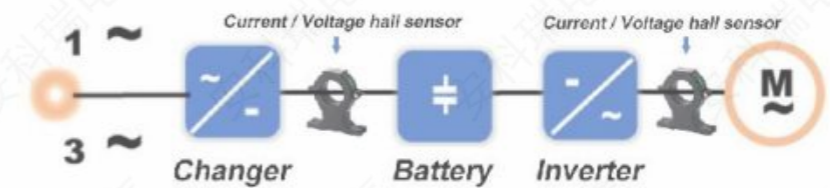

■ Rectifier

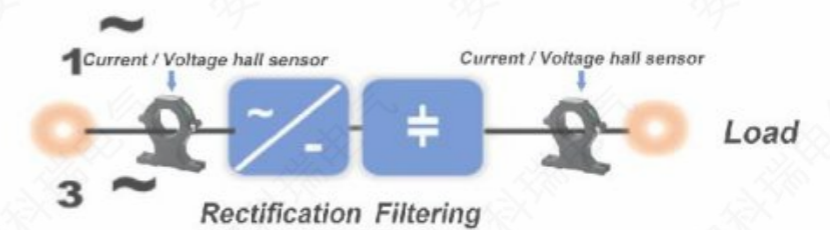

3. Main Functions

Type	Function
Open loop Hall sensor	1. Class 1 2. Easy installation 3. Input range width: 50A-20000A 4. Output: 4V/5V/20mA/4-20mA
Closed loop Hall sensor	1. Class 0.5 2. Input: 10A-2000A 3. Fast response times $\leq 1\mu s$ 4. bandwidth: $\leq 100kHz$
Hall voltage transducer	1. Class 0.5 2. Input: 100-5000V 3. Fast response times $\leq 200\mu s$ 4. bandwidth: $\leq 100kHz$

4. Product selection

Type	Rated Input	Rated Output	Measuring Aperture	Power Supply	Application
AHKC-EKA	0-(50-500)A	5V/4V	20mm	$\pm 15V$	1. Photovoltaic DC cabinet
AHKC-EKAA	DC 0-(50-500)A	4-20mA	20mm	12V/24V	2. photovoltaic inverter/wind inverter
AHKC-BS	0-(50-500)A	5V/4V	20.5*10.5mm	$\pm 15V$	3. The data center
AHKC-F	0- (200-1000) A	5V/4V	43*13mm	$\pm 15V$	
AHKC-K	0- (400-2000) A	5V/4V	64*16mm	$\pm 15V$	
AHLC-LTA	100A-300A	50mA/100mA	20mm	$\pm 15V$	UPS
AHBC-LF	2000A	400mA	/	$\pm 12V \sim \pm 24V$	1. UPS 2. photovoltaic inverter
AHBC-LT1005	1000A	200mA	/	$\pm 12V \sim \pm 24V$	UPS

Smart Motor Control and Protection Solution

1. Application

- ◆ Chemical Industry
- ◆ Mining Industry
- ◆ Power Plant
- ◆ Metallurgical Industry
- ◆ Pump Station

2. Structure

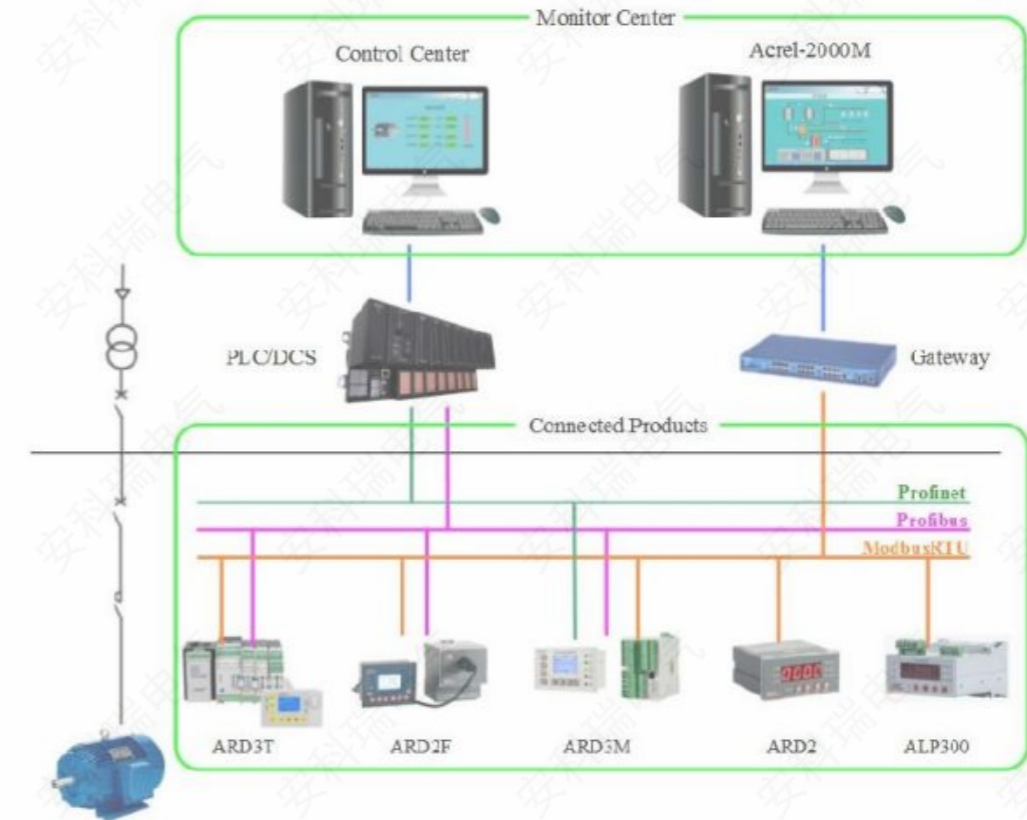

3. Main Functions

Protection function	Start timeout	External Fault	UnderPower
Overload	Overload	Insulation Fault	tE time
Underload	Underload	OverVoltage	Loss of pressure (anti-shake)
Short circuit	Short circuit	Undervoltage	4-20mA input protection
Blocking	Blocking	Phase Failure	Ground
Stall	Stall	Phase Sequence	Leakage
Unbalance	Unbalance	OverPower	

Certification	CE
Communication	Modbus-RTU、Modbus-TCP、Profibus-DP、Profinet

4.Product selection

	ARD2/ARD2L	ALP300	ARD2F	ARD3	ARD3T	ARD3M	
Application	Low voltage 0.4kv-1.14kv motor protection						
Protective function	Start timeout			√			
	Overload			√			
	Underload			√			
	Short circuit			√			
	Blocking			√			
	Stall			√			
	Unbalance			√			
	External Fault	■	■	■	√	√	√
	Insulation Fault						√
	OverVoltage		√	■	■	■	√
	Undervoltage		√	■	■	■	√
	Phase Failure	√	√	√	√	√	√
	Phase Sequence			■	■	■	√
	OverPower			■	■	■	√
	UnderPower			■	■	■	√
	tE time			■	■	■	√
	Loss of pressure (anti-shake)			■	■	■	■
	4-20mA input protection					■	
	Ground				√		
	Leakage			■			
Communication function	ModbusRTU	■	■	■	■	√	
	Double ModbusRTU			■	■	■	
	Profibus DP			■	■	■	
	Double Profibus DP						
	Profinet						
	Modbus TCP						
Switch input	2	2	9	9	8	10	
Relay output	4	4	5	5	7	6	
Start control			■	√	√	√	

	ARD2/ARD2L	ALP300	ARD2F	ARD3	ARD3T	ARD3M
4-20mA analog output				■		
Record	■		■	■	√	■
Operational information record					√	√
Logic function					√	√
Parameter measurement	Three-phase current			√		
	Leakage current			■		
	Three-phase voltage			■	■	■
	Power, power factor			■	■	■
	Frequency			√	√	√
	Electric energy			■	■	■
	PTC/NTC			■	■	√
	4-20mA input					■
	Temperature measurement module					■

Temperature and Humidity Measurement Solution

1.Application

- ◆ Mid/High voltage switchgear
- ◆ Distribution cabinet
- ◆ Box Transformer Substation
- ◆ Terminal box

2.Structure

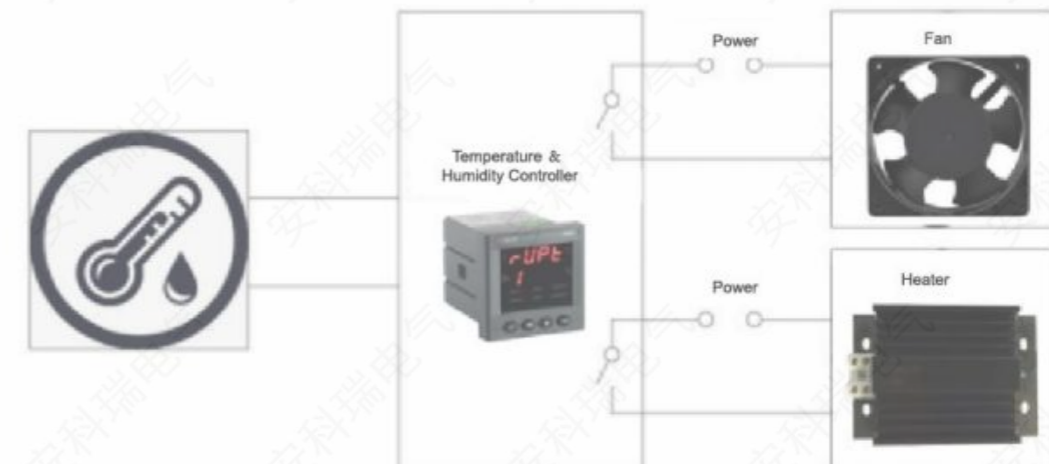

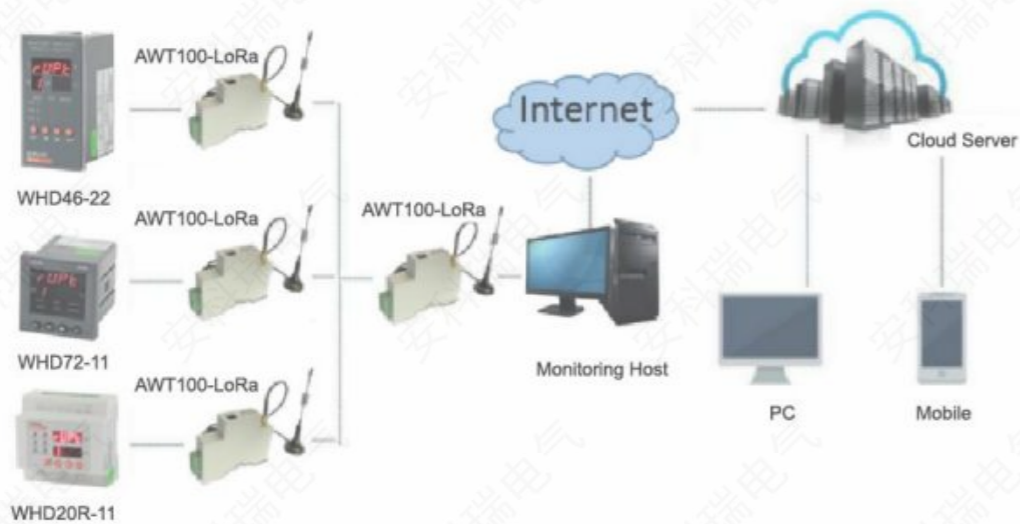
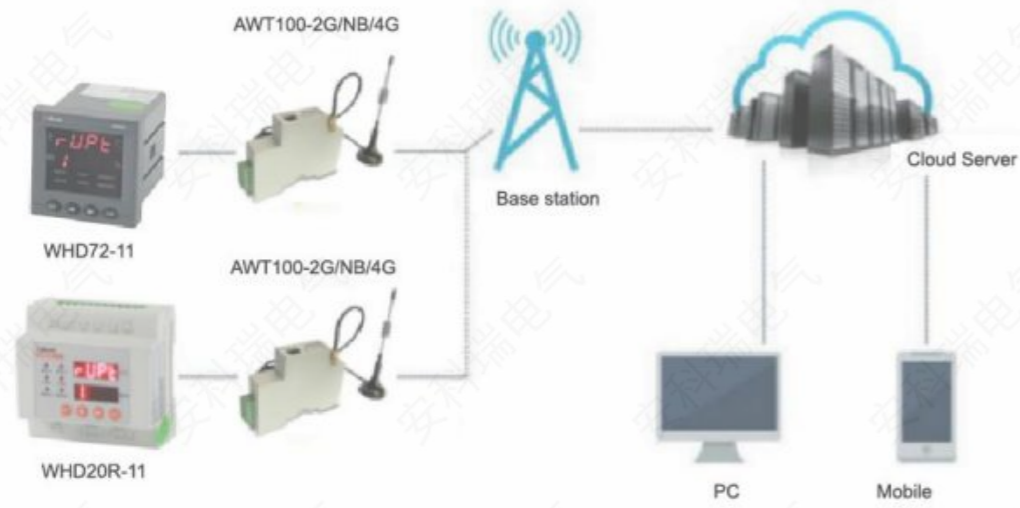

➤ 3.Main Functions

- ◆ Automatic heating and dehumidification
- ◆ Communication: RS485(Modbus-RTU)
- ◆ Humidity measurement range: 0-99%RH
- ◆ Temperature measurement range: -40℃~99.9℃
- ◆ Working humidity of controller: ≤95%RH
- ◆ Working temperature of controller:-20℃~60℃
- ◆ LED Display
- ◆ Analog output
- ◆ Alarm

➤ 4.Product Selection

	Type	Functions
Temperature & Humidity Controller	WHD48	Panel mounted 1 channel RS485(Modbus-RTU) LED Display Temperature ±1℃ Humidity ±5%RH
	WHD72	Panel mounted 2 channels RS485(Modbus-RTU) LED Display Temperature ±1℃ Humidity ±5%RH
	WHD46	Panel mounted 3 channels RS485(Modbus-RTU) LED Display Temperature ±1℃ Humidity ±5%RH
	WHD20R	DIN rail mounted 2 channels RS485(Modbus-RTU) LED Display Temperature ±1℃ Humidity ±5%RH
Heater	ALW-100W	Operating Voltage:AC220V AC110V Rated Power:50-300W Insulation resistance:≥1000MΩ
Smart Gateway	AWT100	Working pressure: DC24V orAC/DC220V Baud Rate: 4800bps、9600bps、19200bps、38400bps Communication: RS485

Power Monitoring System

1.Application

- ◆ State Grid
- ◆ Municipal Engineering
- ◆ Traffic Industry
- ◆ Petroleum
- ◆ Data Center
- ◆ Chemical Industry
- ◆ Industrial and Mining Enterprise
- ◆ Metallurgical Industry

2.Structure

Power Monitoring System

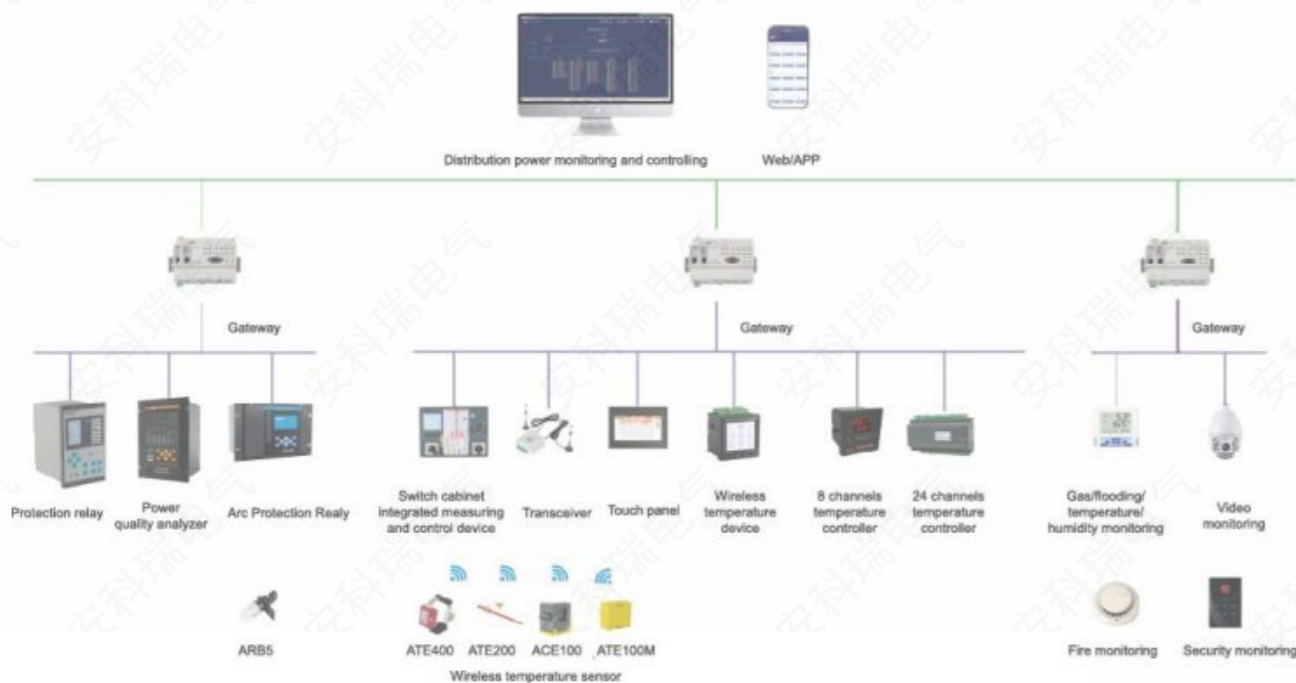

Report



Curve



Fault recorder



Harmonic Monitoring



Web/APP



3.Main Functions

- Remote Measuring, Signal



4.Product Selection

Name	Model	Functions
Protection Relay	AM5SE	Line Protection, Transformer Differential Protection, Transformer Protection, Motor Differential Protection, Transformer Protection, Capacitor Protection Monitoring, Standby power Automatic Transfer Protection Monitoring, Voltage Transformer Supervision and Parallel Connection, Public measurement and control.
	AM5	Line Protection, Transformer Protection, Motor Protection, Capacitor Protection, Standby power Automatic Transfer Protection, Voltage Transformer Supervision, Public measurement and control, Undervoltage Standby power Automatic Transfer Protection.
	AM4	Line Protection, Transformer Protection, Voltage Transformer Supervision.
	AM3SE	Line Protection, Transformer Protection, Voltage Transformer Supervision.
	AM2SE	Line Protection, Transformer Protection
Advanced Power Device	APView500	Advanced power quality analysis and revenue-accurate.
Wireless Temperature Sensors	ATE100M	Temperature measurement of moving contacts and fixed contacts of breaker, cable joints and bus bar.
	ATE200	
	ATE400	
Wireless Temperature Measurement	ATC450-C	Temperature Data Transmission, 1 RS485.
	ATC600-C	
Multi Channel Temperature Controller	ARTM-8	Transformer, motor temperature measurement, 1 RS485, 2DO.
Wireless Temperature Measuring Equipment	ARTM-Pn	Temperature acquisition and display, 1 RS485, 2 DI, 2 DO.
Arc Protection Relay	ARB5	Arc protection

Wireless Temperature Monitoring System

1.Application

- ◆ State Grid
- ◆ Municipal Engineering
- ◆ Traffic Industry
- ◆ Petroleum
- ◆ Data Center
- ◆ Chemical Industry
- ◆ Industrial and Mining Enterprise
- ◆ Metallurgical Industry

2.Structure

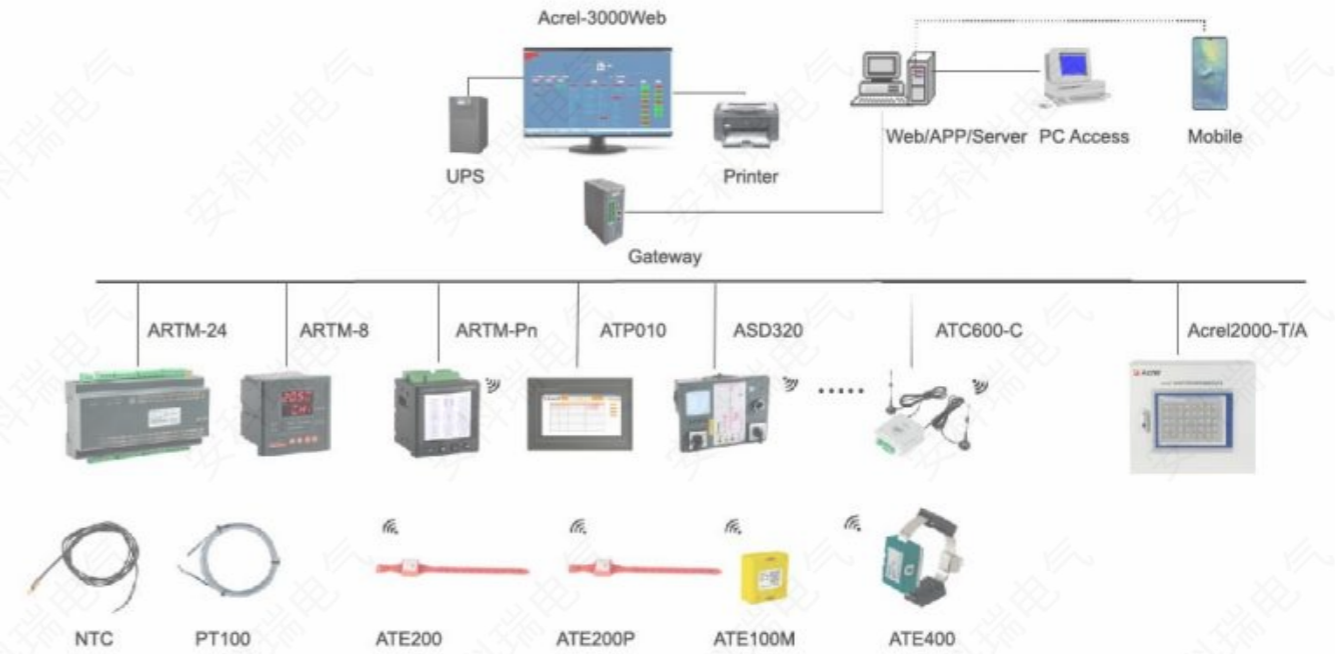

3.Main Functions

- Temperature display



■ Report



■ Curve



■ Web/APP

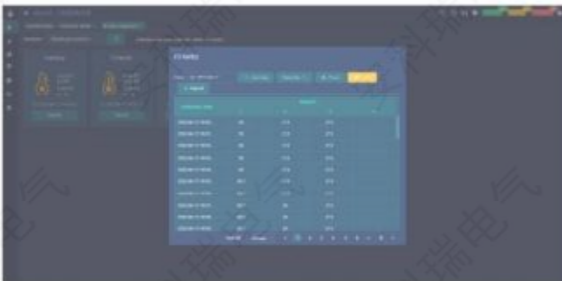

➤ 4.Product Selection

Model	Functions
ATE400	Small size;Wireless transmit;Wireless transmission distance, 150 meters/470MHZ, 50meters/433MHZ;sampling frequency 15s; transmitting frequency 15s;CT-powered, more than 5A starting current; Widely temperature measuring range, -40℃~125℃.
ATE200	Wireless transmit;Wireless transmission distance, 150 meters/470MHZ, 50meters/433MHZ;sampling frequency 25s;transmitting frequency 25s~5min; Battery -powered,more than 5 years(25℃);Widely temperature measuring range, -40℃~125℃.
ATE100M	Wireless transmit;Wireless transmission distance, 150 meters/470MHZ, 50meters/433MHZ;sampling frequency,25s;transmitting frequency 25s~5min; Battery-powered,more than 5 years(25℃); Widely temperature measuring range, -40℃~125℃.
ATE200P	Wireless transmit;Wireless transmission distance, 150 meters/470MHZ, 50meters/433MHZ;sampling frequency,25s;transmitting frequency 25s~5min; Battery-powered,more than 5 years(25℃);Widely temperature measuring range, -40℃~125℃;IP68.
ATC600-C	Wireless temperature measurement;Measuring 240 points; 1 RS485 serial communication, Modbus-RTU;2 alarm relays; Power supply adapt with AC/DC220V,AC/DC110V,DC12~48V.
ARTM-Pn	Wireless temperature measurement, 60 points;U, I, P, Q, f, Ep, Eq measurement; 4 digital inputs;2 alarm relays, high temperature alarm;LCD display;Power supply adapt with AC220V, DC220V, DC110V, AC110V;1 RS485 serial communication, Modbus-RTU.
ARTM-24	24 channel temperature inspection instrument thermocouple,NTC PT100,PT1000 Input;2 alarm relays;1RS485 serial communication,modbus-RTU;power supply adapt with AC/DC 220V,AC/DC 110V,DC12~18V
Acrel-2000T/A	Wireless temperature measurement, 240 points;Power supply adapt with AC220V, DC220V, DC110V, AC110V;Temperature Curve;High temperature alarm, buzzer; 1 RS485 serial communication, Modbus-RTU; 1 Ethernet communication.

Residual Current Operated Relay

1.Application

- ◆ Subway
- ◆ large gymnasium
- ◆ Power plant
- ◆ Petrochemical industry
- ◆ Pharmaceutical industry
- ◆ Mining industry
- ◆ Photovoltaic new energy

2.Structure

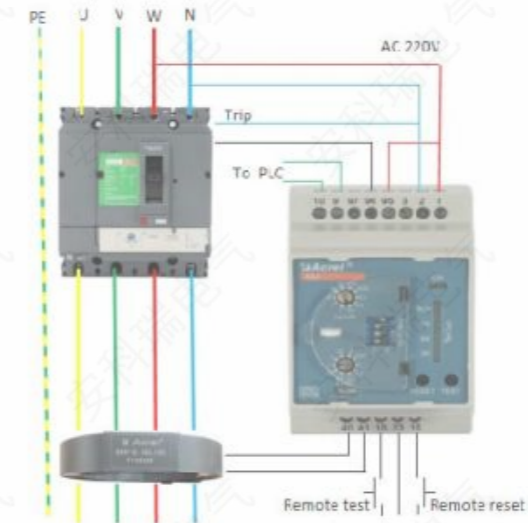
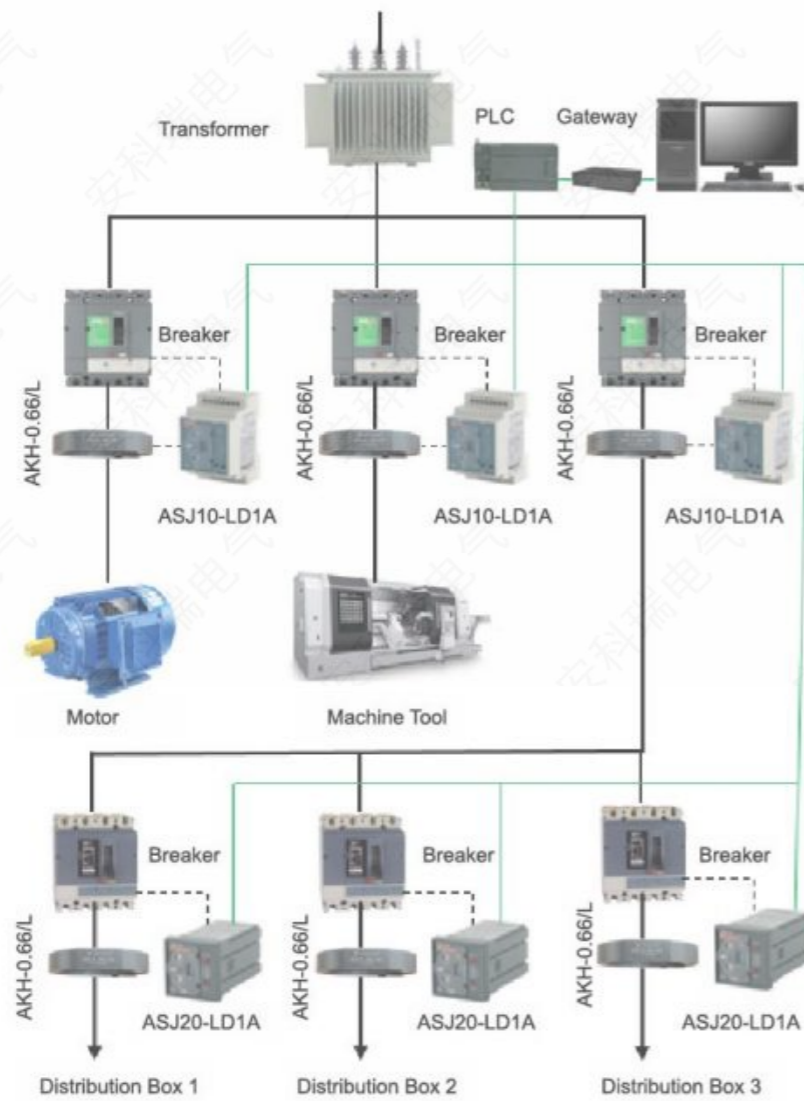

- Collect switch signals by PLC, and upload to monitoring system



- RS485 connection



3.Main Functions

- ◆ Cooperate with AC contactor or circuit breaker, to realize earth fault protection and fire protection.
- ◆ Adjustable $I_{\Delta n}$: 0.03A to 30A.
- ◆ Adjustable limiting non-actuating time: 0 to 30s.
- ◆ 2DO (warning and alarm)
- ◆ Manual, auto and remote reset

4.Product Selection

Model	Installation	Functions
ASJ10-LD1C	DIN35mm	Measurement of type AC residual current Alarm when the residual current exceeds the set value Adjustable rated residual current from 0.03 to 0.5 A Adjustable limiting no-actuating time from 0.1s to 0.5s 2 relay output(1 NC contact,1 normal changeover contact) Local/ remote "test" and "reset" function
ASJ10-LD1A		Measurement of type A residual current Residual current percentage light bar indication (30%,50%,70%,TRIP) Adjustable rated residual current from 0.03 to 30 A Adjustable limiting no-actuating time from 0.1 to 10s 2 programmable relay output(1 NC contact,1 normal changeover contact).Local/ remote/automatic "test" and "reset" function
ASJ10L-LD1A		Measurement of type A residual current Continuously adjustable of Rated residual current from 0.03 to 30 A Continuously Adjustment of limiting no-actuating time 0.1 to 10s 2 programmable relay output(1 NC contact,1 normal changeover contact) Local/ remote/automatic "test" and "reset" function Multi-function LC display RS485 communication with modbus-RTU protocol
ASJ20-LD1C		Measurement of type AC residual current Alarm when the residual current exceeds the set value Adjustable rated residual current from 0.03 to 0.5 A Adjustable limiting no-actuating time from 0.1s to 0.5s 2 relay output(1 NC contact,1 normal changeover contact) Local/ remote "test" and "reset" function
ASJ20-LD1A		Measurement of type A residual current Residual current percentage light bar indication (30%,50%,70%,TRIP) Adjustable rated residual current from 0.03 to 30 A Adjustable limiting no-actuating time from 0.1 to 10s 2 programmable relay output(1 NC contact,1 normal changeover contact) Local/ remote/automatic "test" and "reset" function

Accessories: AKH-0.66/L series residual current transformer

Model	Rated Load	Ratio	Class	Φ (mm)
L-35	16~100A	5A/5mA	0.5	35
L-70	100~250A	5A/5mA	0.5	70
L-105	250~400A	5A/5mA	0.5	105
L-45	16~100A	5A/5mA	1	45
L-80	100~250A	5A/5mA	1	80
L-100	250~400A	5A/5mA	1	100
L-150	400~800A	5A/5mA	1	150
L-200	800~1500A	5A/5mA </td <td>1</td> <td>200</td>	1	200

Model	Rated Load	Ratio	Class	Φ (mm)
L-80×50II	16~100A	5A/5mA	0.5	82×52
L-100×50II	16~100A	5A/5mA	0.5	103×55
L-130×50II	100~200A	5A/5mA	0.5	135×55
L-150×130II	100~300A	5A/5mA	0.5	150×133
L-180II	100~200A	5A/5mA	0.5	182×35
L-200×50II	250~400A	5A/5mA	0.5	202×61
L-260×100II	450~800A	5A/5mA	0.5	265×104
L-170 × 30	100~200A	5A/5mA	1	172×34
L-210×160	450~800A	5A/5mA	0.5	210×160

Energy Management System

1.Application

- ◆ State Grid
- ◆ Municipal Engineering
- ◆ Traffic Industry
- ◆ Petroleum
- ◆ Data Center
- ◆ Chemical Industry
- ◆ Industrial and Mining Enterprise
- ◆ Metallurgical Industry

2.Structure

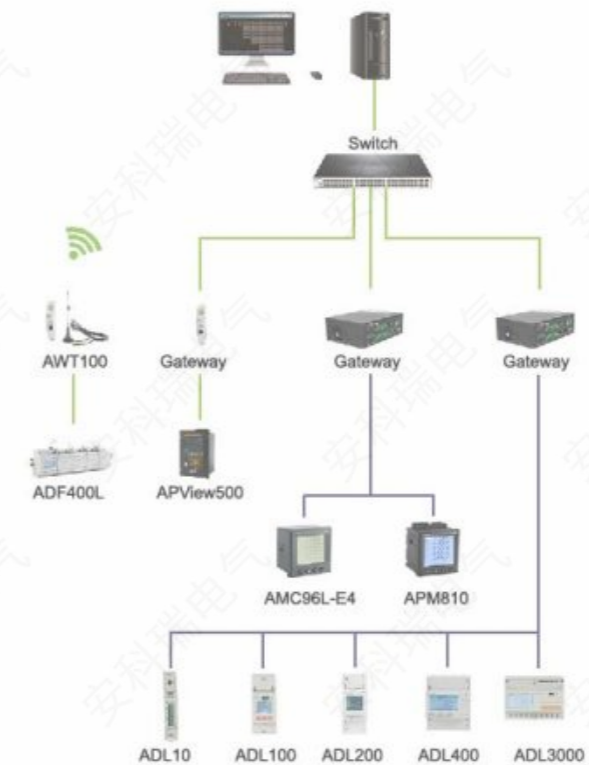

3. Main Functions

Overview of Energy Consumption



Statistics of Energy Consumption



Data Reading



Analysis Report on Energy Consumption

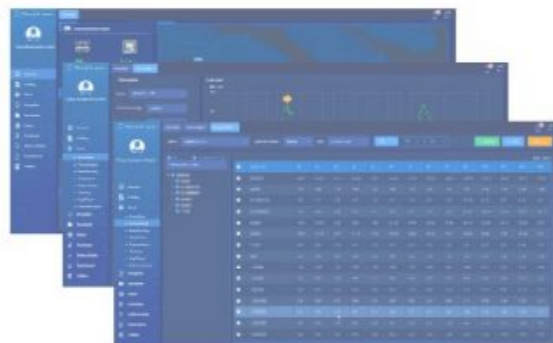

4. Product Selection

Application	Type	Functions
Gateway	AWT100	Ethernet Gateway, For simple, cost-effective serial-to-Ethernet connectivity
	Anet	Smart IoT Gateway, Embedded Linux platform, high performance, low power consumption, real-time monitoring, Convenient management
Advanced power quality analysis	APView500	Advanced power quality analysis and revenue-accurate
Energy meter	AMC96L-E4	Installation: panel mounted; U, F, P, Q, S, PF, E; Standard RS485 port and Modbus RTU protocol
	APM810	Installation: panel mounted; U, F, P, Q, S, PF, E; Standard RS485 port and Modbus RTU protocol 2xDI, 2xDO Power quality Demand
	ADL10	DIN rail mount; U, F, P, Q, S, PF, E; 63A direct current input 8-digit LCD Display Standard RS485 port and Modbus RTU protocol
	ADL100-ET	DIN rail mount; U, F, P, Q, S, PF, E; 63A direct current input 8-digit LCD Display Standard RS485 port and Modbus RTU protocol
	ADL200	DIN rail mount; U, F, P, Q, S, PF, E; 80A direct current input 8-digit LCD Display Standard RS485 port and Modbus RTU protocol
	ADL400	DIN rail mount; U, F, P, Q, S, PF, E; 80A Direct Input or 5A CT Input 8-digit LCD Display Power quality monitoring Standard RS485 port and Modbus RTU protocol
	ADL3000-E	DIN rail mount; U, F, P, Q, S, PF, E; 80A Direct Input or 5A CT Input 8-digit LCD Display Power quality monitoring Standard RS485 port and Modbus RTU protocol
	ADF400L	DIN rail mount 36 circuits single phase 80A direct input Or 12 circuits 3 phase 80A direct input Or 12 circuits 3 phase 5A CT Input I, U, F, P, Q, S, PF, E; Standard RS485 port and Modbus RTU protocol

Prepaid Solution

1.Application

- ◆ Chain Stores
- ◆ Chain Hotels
- ◆ Properties
- ◆ University Dormitories
- ◆ Intelligent Communities

2.Structure

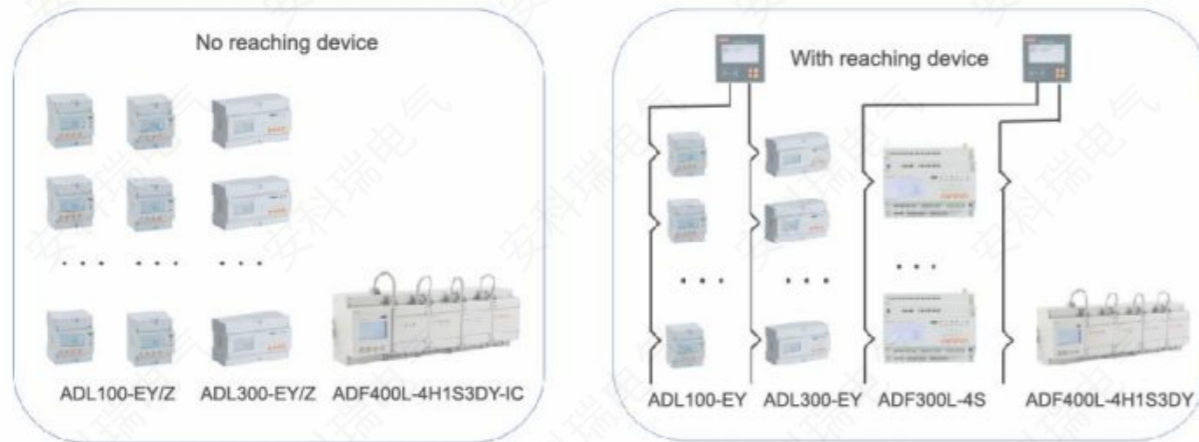

3.Main Functions

- Card recharge software overview

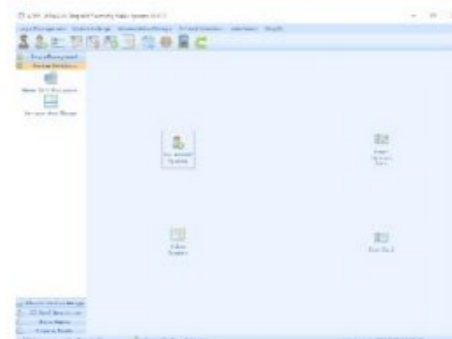

- Open account

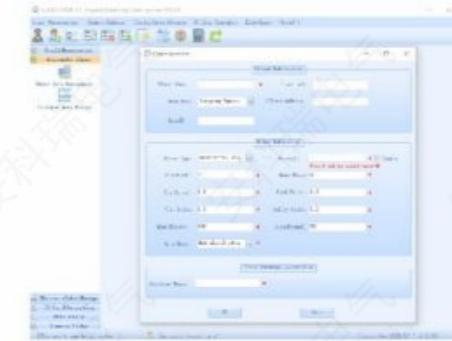

- Electricity recharge



- Electricity recharge report

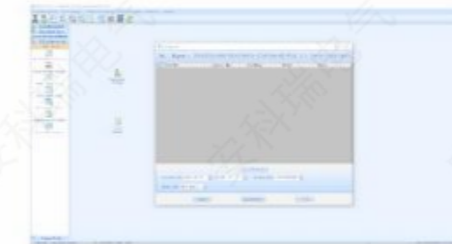

4.Product Selection

Type	Functions
ADL100-EY	Single phase; 10(60)A Direct connect internal relay; Remote recharge
ADL300-EY	Three phase; 10(80)A Direct connect, internal relay; 1(6)A CT connect, out relay; Remote recharge
ADL100-EY/Z	Single phase; 10(60)A Direct connect internal relay; RF card or remote recharge
ADL300-EY/Z	Three phase; 10(80)A Direct connect internal relay; RF card or remote recharge
ADK100-EY/RF	Single phase; 10(60)A Direct connect Out relay; RF card
ADL300-EY/RF	Three phase; 10(80)A Direct connect out relay; RF card
ADF300L-RF	RF card Recharge device
M&W	Card reader
Acrel-RFMS	Prepaid recharge software

Photovoltaic System Solutions

1. Distributed Photovoltaic Solutions

1.1 Application

- ◆ Backflow prevention
- ◆ Energy storage
- ◆ Bidirectional energy metering

1.2 Structure

■ Solution for PV anti-backflow

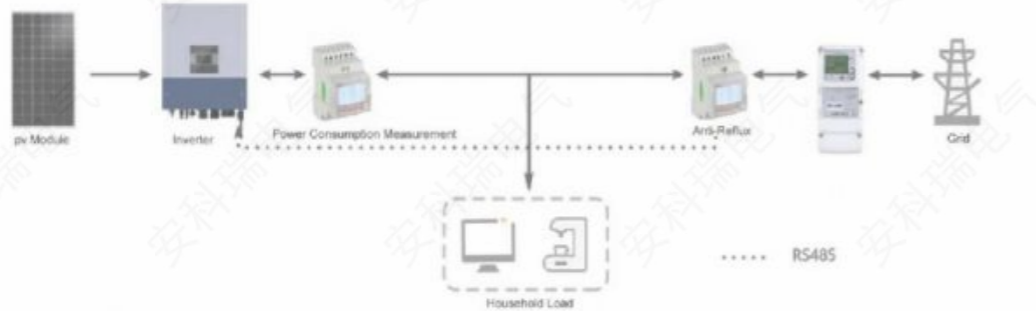

■ Solution for PV DC coupled energy storage

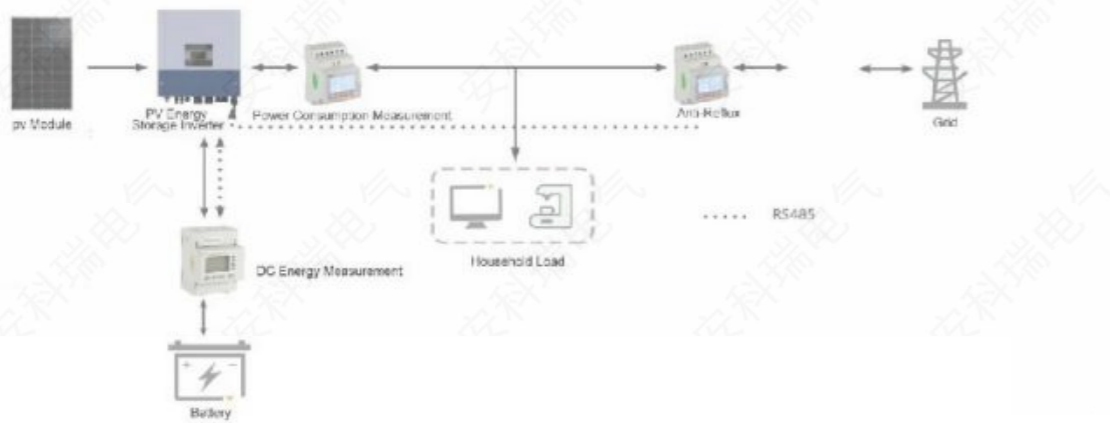

■ Solution for photovoltaic AC coupled energy storage

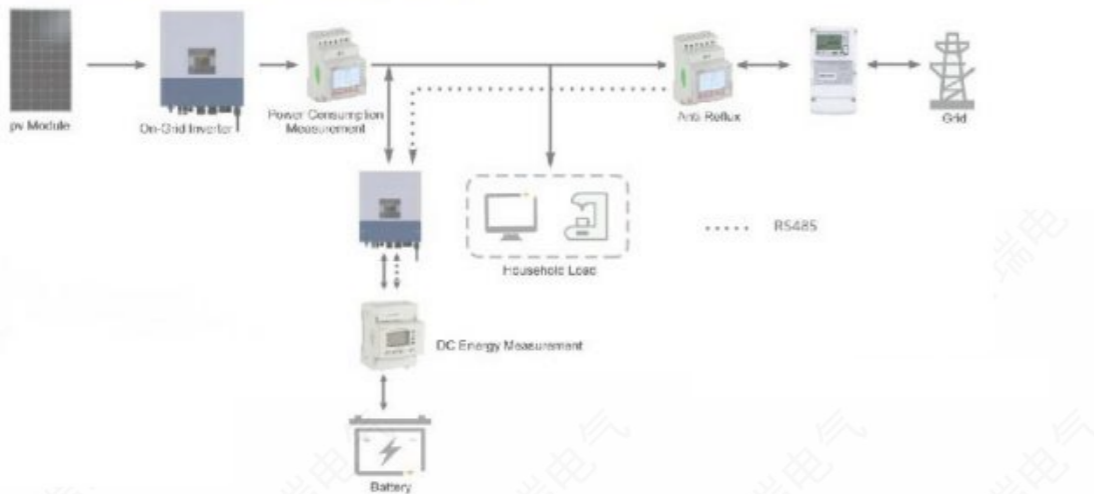

1.3 Main Functions

- Measure power generation and the use of electricity;
- Data refresh rate: 250ms;
- Split core CT, 300A current;
- Communication: RS485 and grid-connected inverter or energy storage inverter.

■ DJSF1352-RN DC Energy Meter

- Accuracy: 1, voltage output: ±12V;
- Communication: infrared and RS485 communication, Modbus-RTU and 645 protocol;
- DIN rail installation;
- Support hall sensor or shunt input.

1.4 Product Selection

Application	Model	Functions
Single phase	ACR10R-DxxTE	Current/voltage/frequency/power factor;Active power/reactive power/apparent power;Four quadrant electric energy measurement; Modbus(RS485)
Two phase	AGF-AE-D	Current/voltage/frequency/power factor;Active power/reactive power/apparent power;Four quadrant electric energy measurement; Suport Sunspect protocol(RS485)
Three phase	ACR10R-DxxTE4	Current/voltage/frequency/power factor;Active power/reactive power/apparent power;Four quadrant electric energy measurement; Maximum demand;Multiple rate electric energy measurement Total harmonic content/ subharmonic (2-31 times) ;Modbus(RS485)

2. Centralized PV Solutions

2.1 Application

- ◆ Centralized photovoltaic confluence collection

2.2 Structure

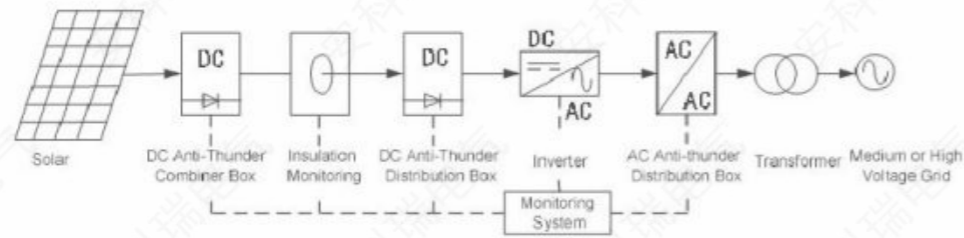
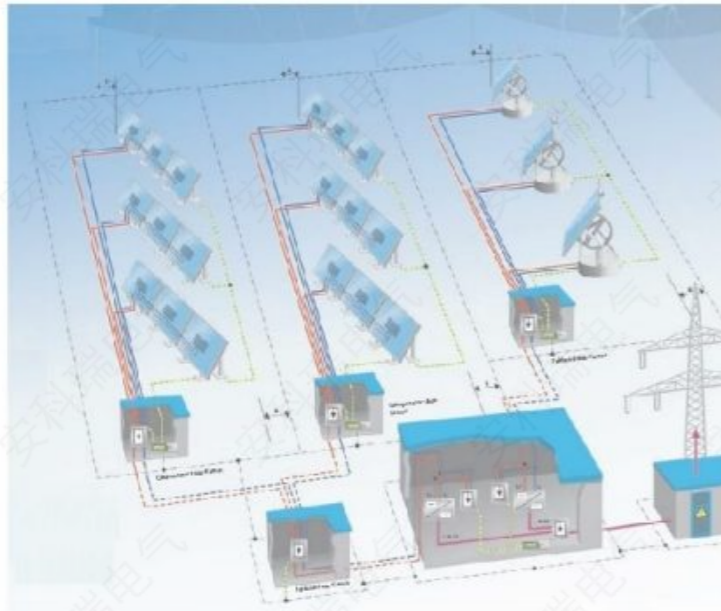

2.3 Main Functions

Current specification: 20A, perforation connection, 3 DI

Temperature measurement Busbar voltage measurement: DC 1500V, LCD display

■ APQM Power Quality Monitoring Device

Measurement of electrical parameters, harmonics, inter-harmonics, voltage fluctuation, flicker;

Monitoring of voltage swell, voltage sag, voltage interruption;

Statistics of power quality limit times, voltage qualification rate, and form the report.

2.4 Product Selection

Type	Functions
AGF Series Confluence Acquisition	Primary current is connected in through perforation. Easy installation, high safety; With Hall sensor, the max isolation measuring current 20A; Voltage measurement range for Bus bar is up to DC1.5kV; LED display, fit for checking and testing operation in wide-temperature or outside environment; With the function of inner temperature measurement for real-time measurement of the inner temperature of combiner box; With RS485 Modbus RTU; More options of power supply; Compatible with din rail installation and baseboard fixation installation, small dimension saving more box space.

Smart Busway Monitoring Solution

1. Application

- ◆ Connection between low voltage cabinet
- ◆ Incoming line system at voltage transformer connection
- ◆ Power distribution in factory
- ◆ Power supply in high buildings
- ◆ Device with big current

2. Structure

■ Smart Bus Bar Monitoring System

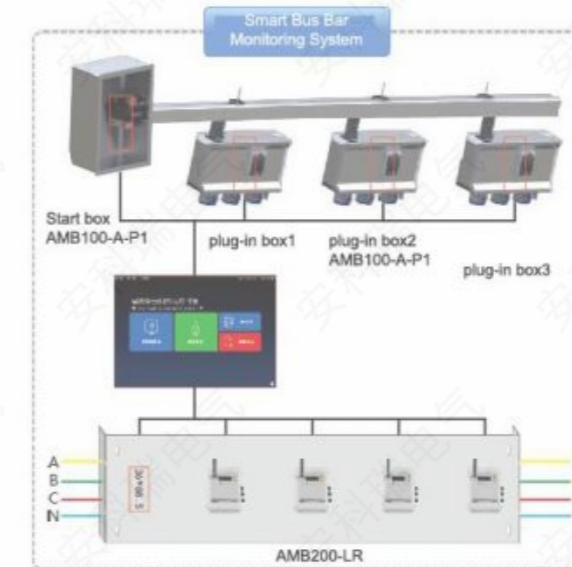

■ Networking Scheme



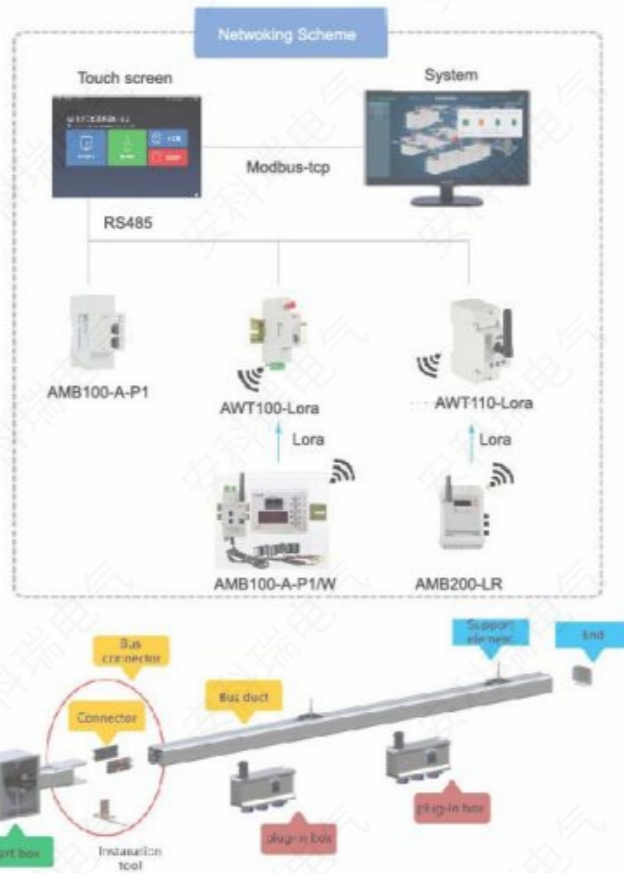

Name	Type	Functions
DC start box monitoring module	AMB100-D-P1	Installation:DIN Rail 35mm; Measurement:1 DC circuit electrical parameters,4DI2DO,8 temp.,1 leakage current,1 temp. and humidity; ±12V output to power hall current sensor; Communication:1 in 1 out type RJ45 interface(Modbus protocol)
DC plug-in box monitoring module	AMB110-D-P1	Installation:DIN Rail 35mm; Measurement:3 DC circuits electrical parameters,4DI2DO,4 temp.,1 leakage current,1 temp. and humidity; ±12V output to power hall current sensor; Communication:1 in 1 out type RJ45 interface(Modbus protocol)
AC bus connector temp measurement device	AMB200-LR AMB200-C	Installation: Fixed on the cover of the busbar connection; Contact temp. measurement,measure and display temp. of 4 AC busbars; Communication:RS485 or LoRa
DC outgoing line hall effect current sensor	AHKC-BS	Current ratio: 100A/5V Common Specification: 100A/5V

Precision Distribution Monitoring Solution For IDC

3.Main Functions

- ◆ AMB100 or AMB110 is usually installed in the busbar start box and plug-in box
- ◆ Measurement:AC or DC busbar voltage,current,harmonics and other parameters.
- ◆ Realize temperature monitoring of the busbar plug interface
- ◆ AMB200 is usually installed at the connector of the dense AC busbar,and can monitor temp. and humidity at the connector.

- ◆ Communication:LoRa or RS485

4.Product Selection

Name	Type	Functions
HMI	ATP010kt	10 inch touch screen; Real-time monitoring and display voltage,current, power,energy,power quality,switch status,wave curve,etc. of the busbar; monitoring device alarm,communication and other parameters can be configured on the screen; 2 RS485 and 1 Ethernet,and data can uploaded by RS485 or RJ45
AC start box monitoring module	ATP010kt	Installation:DIN Rail 35mm; Measurement:3 phase electrical parameters, 2DI2DO,8 temp.,1 leakage current,1 temp. and humidity; Communication: 1 in 1 out type RJ45 interface(Modbus protocol)
AC plug-in box monitoring module	AMB110-A-P1	Installation:DIN Rail 35mm; Measurement:3 phase electrical parameters, 2DI2DO,4 temp.,1 leakage current,1 temp. and humidity; Communication: 1 in 1 out type RJ45 interface(Modbus protocol)

1.Application

- ◆ Power monitoring at the end of data center
- ◆ Multi channel power distribution box of the floor

2.Structure

Monitoring System for Data Centre Energy Management

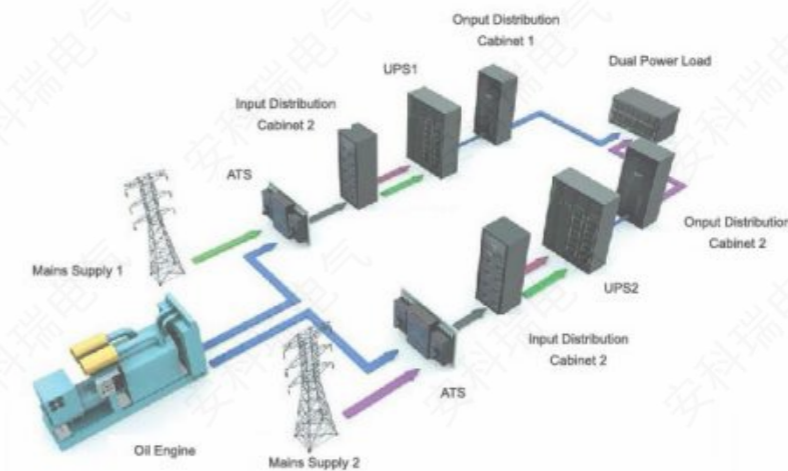

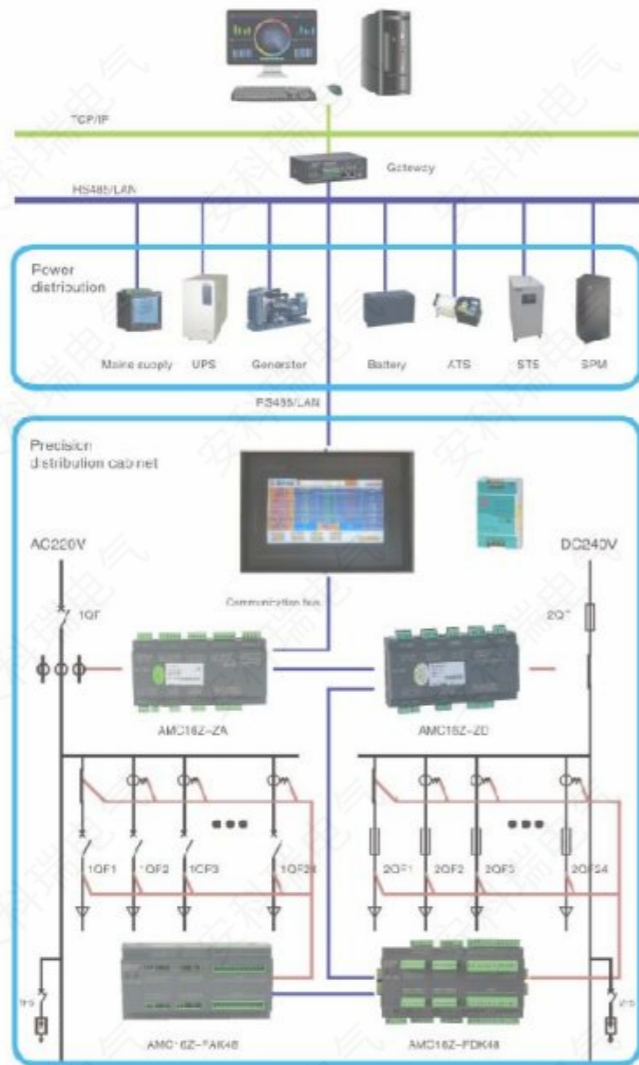

➤ 3.Main Functions

- ◆ Incoming line and outgoing line circuits independent monitoring modules
- ◆ Can measure up to 2 incoming line circuits and up to 192 outgoing line circuits current,voltage, power,energy and power quality.
- ◆ Data centralized monitoring and display by HMI and data is uploaded to power and environment monitoring system through RS485.
- ◆ For high voltage DC 240V or 336V system,insulation monitoring module can be added to monitor ground insulation resistance of main bus.
- ◆ DC24V power supply for touch screen and outgoing line monitoring module(power supply from main module output)
- ◆ Communication:monitoring device by RS485,touch screen by RS485 or RJ45
- ◆ Certificate:CE

➤ 4.Product Selection

Name	Type	Functions
HMI	ATP007kt ATP010kt	7 or 10 inch touch screen ; Real-time monitoring and display voltage, current,power,energy,power quality,switch status,waveform curve and so on ; monitoring device alarm,communication and other parameters can be configured on the screen ; 2 RS485 and 1 Ethernet interface, and data can be uploaded by RS485 or RJ45.
AC incoming line monitoring module	AMC16Z-ZA	Installation:DIN rail 35mmMeasurement:1+2 independent 3 phase circuits, 6DI2DO,2 leakage current,1 temp. and humidity ; With DC 24V output power supply for outgoing line module and touch screen ; Communication:RS485 Modbus RTU
AC outgoing line monitoring module	AMC16Z-FAK24 AMC16Z-FAK48	Installation:DIN rail 35mm;Can measure up to 16 circuit 3 phase or 48 circuit single phase;DC24V power supply;Communication:RS485 modbus RTU
AC outgoing line current transformer	AKH-0.66W	Current ratio : 100A/50mA;Common Specification: 100A/50mA
DC incoming line monitoring module	AMC16Z-ZD	Installation:DIN Rail 35mm;Measurement:1+2 independent circuits, 6DI2DO,1 temp. And humidity;With DC 24V output power supply for outgoing line module and touch screen;Communication:RS485 modbus RTU
DC outgoing line monitoring module	AMC16Z-FDK24 AMC16Z-FDK48	Installation:DIN Rail 35mm ; Can measure up to 48 circuits DC outgoing line ; DC24V power supply ; Communication:RS485 modbus RTU
DC incoming line insulation monitoring module	AMC16Z-ZJY	Installation:DIN Rail 35mm ; Measure 1+2 independent DC circuit ground insulation resistance of main bus ; DC24V power supply ; Communication:RS485 modbus RTU
DC outgoing line insulation monitoring module	AMC16Z-FJY	Installation:DIN Rail 35mm ; Measure 24 circuits ground insulation resistance of DC outgoing line
DC outgoing line hall effect current sensor	AHKC-BS	Current ratio : 100A/5V ; Common Specification: 100A/5V

Energy Consumption Monitoring Solution for Base Station

➤ 1.Application

- ◆ Mobile telecom
- ◆ Telecommunication carrier
- ◆ China unicom

➤ 2.Structure

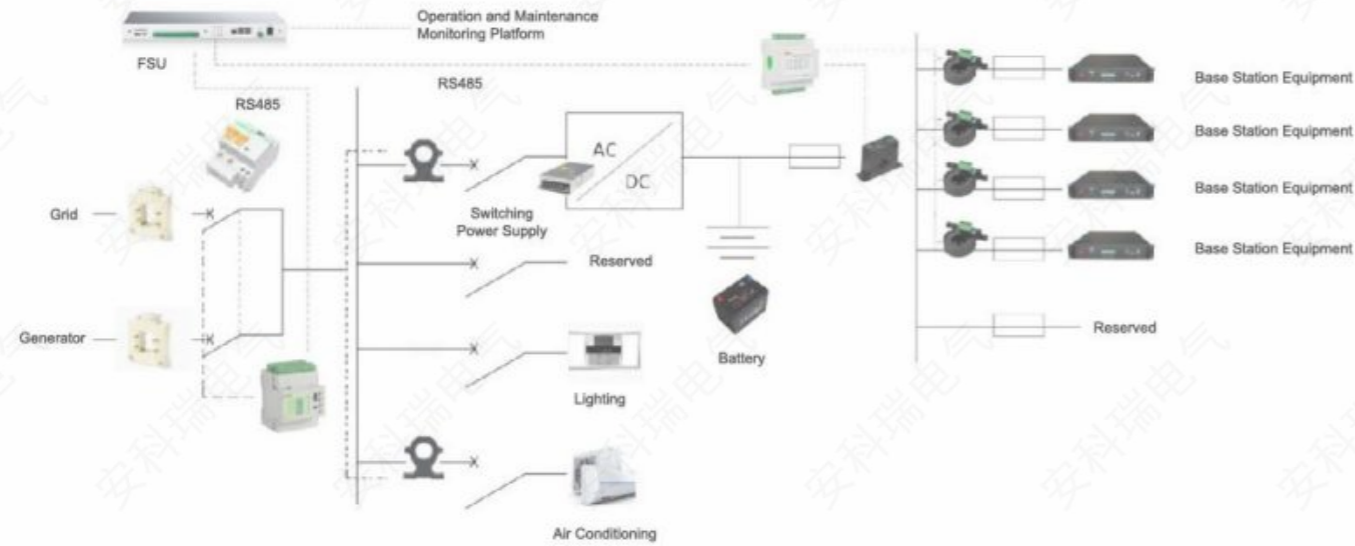

➤ 3.Main Functions

- ◆ Measurement:multi circuits voltage,current,power,energy and other electrical parameters.
- ◆ Communication:RS485 Modbus-RTU,NB or 4G
- ◆ Certificate:With CE and IEC
- ◆ Accuracy:0.5s or 1

➤ 4.Product Selection

Name	Type	Functions
AC single circuit energy meter	AMC96L-E4/KC	Installation:panel mounted; 1 circuit 3 phase input 220V/5A 50/60HZ; Measurement:voltage,current,power,energy and other parameters; Communication:RS485 Mobus RTU

Name	Type	Functions
Multi circuits AC energy meter	AMC96N-4E3	Installation:panel mounted;4 circuits 3 phase or 12 circuits single phase AC input,external CTs,50/60HZ;Measurement:voltage,current,energy and other parameters;Communication:RS485 Mobus RTU
Multi circuits AC energy meter	DTSD1352-xSyD	Installation:DIN Rail 35mm;X circuits 3 phase and Y circuits single phase AC input,external CTs,50/60Hz;Measurement:voltage,current,power,energy and other parameters;Communication:RS485 Modbus RTU
Multi circuits DC energy meter	AMC16-DETT	Installation:DIN Rail 35mm; 6 circuits DC input,-48V voltage input,current input by 5V output hall effect current sensor; Measurement:DC voltage, current,power,energy and other parameters; With ±12V inner power supply for hall effect current sensor; Communication:RS485 Modbus RTU
Wireless energy meter	ADW350	Installation:DIN Rail 35mm;3 circuits DC input or 1 circuit 3 phase AC input;Measurement:voltage,current,power,energy and other parameters; Communication:NB or 4G
Hall Sensor	AHKC	Ratio: 1000A/5V;Common Specification: 1000A/5V

Charging Pile Energy Management System Solution

➤ 1.Application

- ◆ AC and DC charging piles

➤ 2.Structure

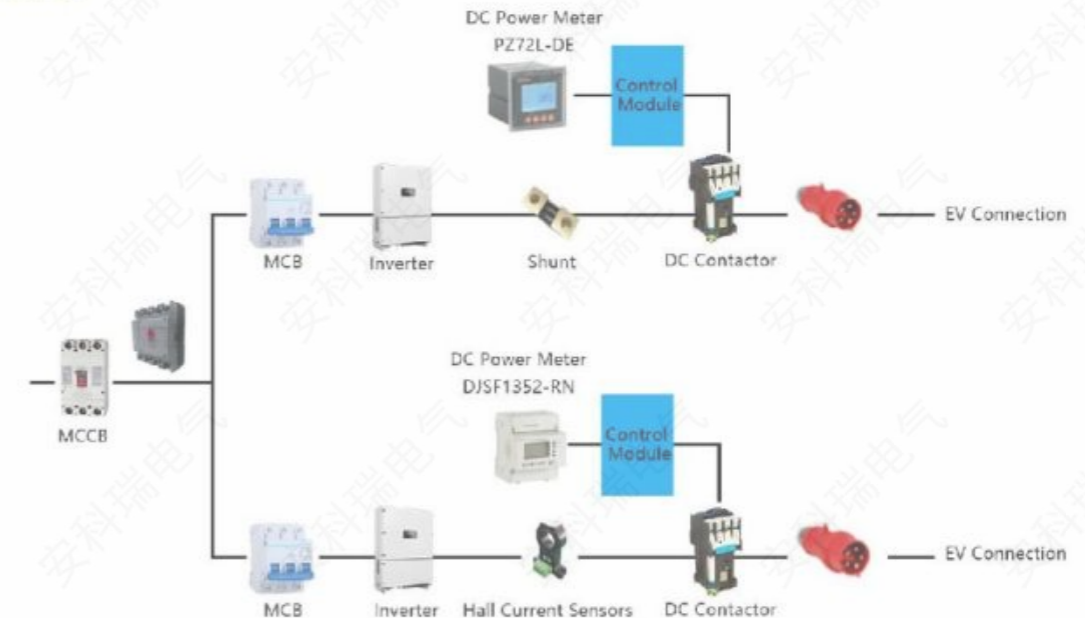

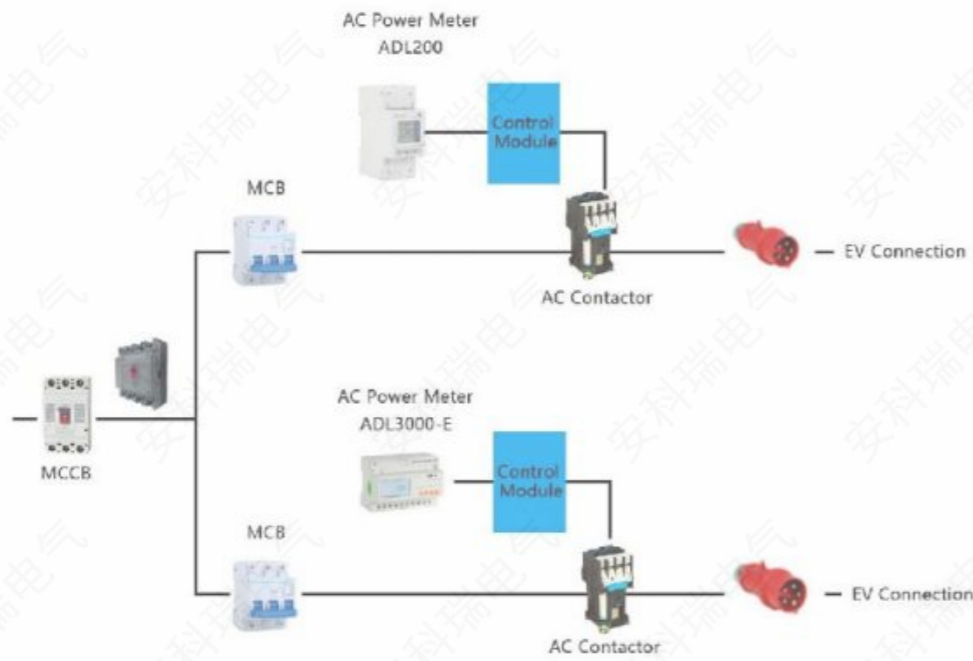

➤ 3.Main Functions

- ◆ Energy Accuracy: Class 0.5S or Class 1
- ◆ Optional multi tariff
- ◆ With CE or IEC certified

➤ 4.Product Selection

Item	Type	Functions
Single Phase AC Energy Meter	ADL10-E	Din rail mounted; single-phase 60A, 50/60Hz input; measurement of electrical parameters such as voltage, current, power, energy; RS485 communication (Modbus protocol).
	ADL100-ET	Din rail mounted; single-phase 60A, 50/60Hz input; measurement of electrical parameters such as voltage, current, power, energy; RS485 communication (Modbus protocol). energy pulse output; optional multi tariff.
	ADL200	Din rail mounted; single-phase 80A, 50/60Hz input; measurement of electrical parameters such as voltage, current, power, energy, etc.; RS485 communication (Modbus protocol); energy pulse output; optional multi tariff.

Item	Type	Functions
Three Phase AC Energy Mete	ADL400	Din rail mounted; three-phase 80A, 50/60Hz input; measurement of electrical parameters such as voltage, current, power, energy; RS485 communication (Modbus protocol); energy pulse output; optional multi tariff.
	ADL3000-E	Din rail mounted; three-phase 80A, 50/60Hz input; measurement of electrical parameters such as voltage, current, power, energy; RS485 communication (Modbus protocol); energy pulse output; optional multi tariff.
DC Energy Meter	PZ72(L)-DE	Din rail mounted; single-phase 80A, 50/60Hz input; measurement of electrical parameters such as voltage, current, power, energy, etc.; RS485 communication (Modbus protocol); energy pulse output; optional multi tariff.
	DJSF1352	Wall mounted, measure DC voltage, current, power; measure DC energy; direct connect voltage 0-1000V; current measurement supports 75mV output of shunt, supports 0-5V, 0-20mA output of hall; RS485(Modbus protocol)
	DJSF1352-RN	Din-rail mounted, support optional two-channel DC voltage, current, power measurement; measure DC energy; direct connect voltage 0-1000V; current measurement support shunt 75mV output, support Hall sensor 0-5V, 0-20mA output; RS485 communication (Modbus protocol)
Shunt	AFL-T	Common Specification: 300A/75mV
Hall Sensor	AHKC	Common Specification: 1000A/5V

Equipment Sets

ANSVG Static Var Generator

1. Model Description

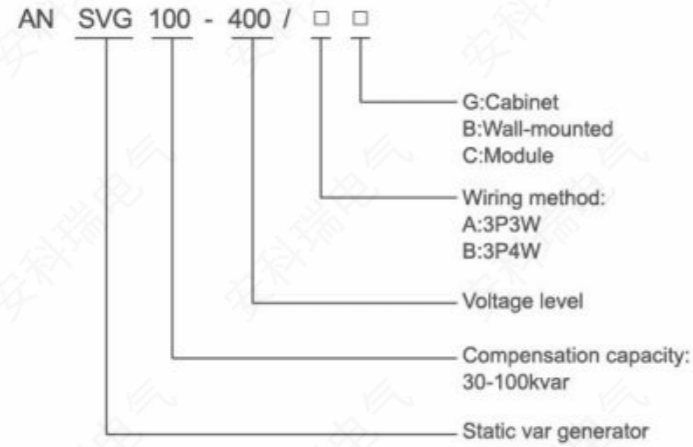

2. Technical Parameter

Rated voltage	380V ±15%
Rated frequency	50Hz ±2%
Compensation method	Linear compensation
Response time	Full response time ≤ 5ms, Instantaneous response time ≤ 100μs
Switching frequency	20kHz
Compensation effect	≥ 0.99, Compensates for capacitive reactive and inductive reactive
Self-loss	≤ 2%
Efficiency	≥ 98%
Total harmonic compensation rate	≥ 97%
Cooling method	Forced air cooling
Noise	≤ 60dB
Operation temperature	-10°C ~ +45°C
Storage temperature	-25°C ~ +60°C
Relative humidity	≤ 95% (No condensation)
Altitude	≤ 1000m
Protection level	IP20
Communication	RS485 (Modbus-RTU) or Ethernet (Modbus-TCP)
Module capacity	30kvar, 50kvar, 75kvar or 100kvar
Working mode	Automatic or manual
Overload protection	Automatic limit to rated current output

3. Structure

◆ Modul

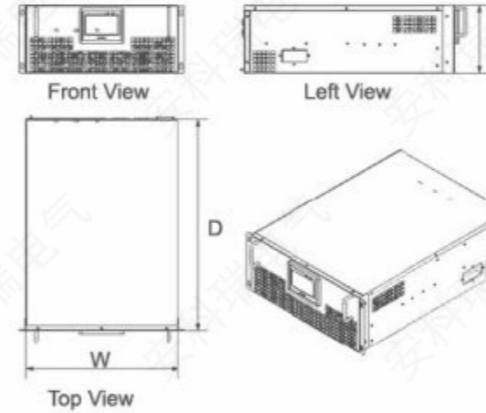

Capacity	Module Size(W*D*H)(mm)	Weight(kg)
30kvar	480*440*130	25
50kvar	450*622*201	35
75kvar	450*622*201	35
100kvar	500*533*280	50

◆ Wall-mounted

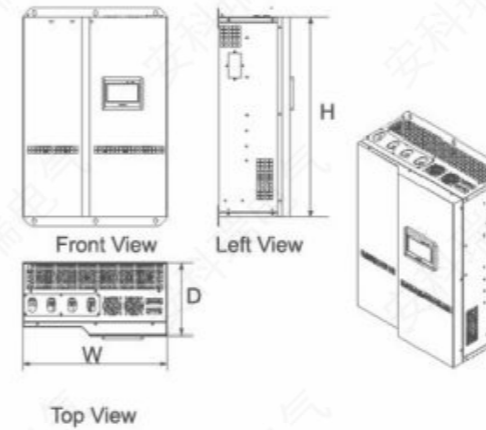

Capacity	Module Size(W*D*H)(mm)	Weight(kg)
30kvar	480*130*440	25
50kvar	450*201*622	35
75kvar	450*201*622	35
100kvar	500*280*533	50

4. Schematic

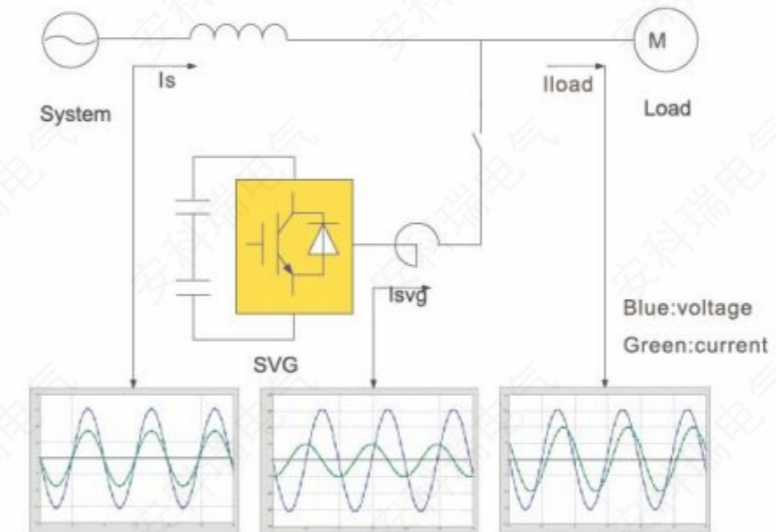

The schematic of ANSVG

ANAPF Active Power Filter

1. Model Description

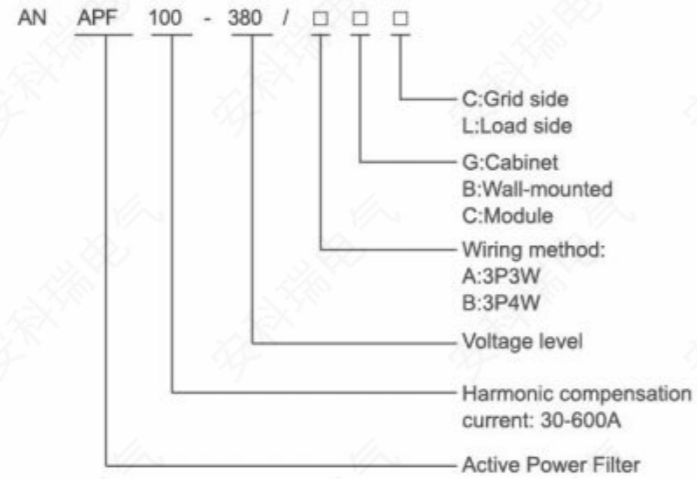

2. Technical Parameter

Wiring method	Three-phase three-wire, Three-phase four-wire
Rated voltage	380V ±15%
Rated frequency	50Hz ±2%
Compensation method	Linear compensation
Response time	Full response times ≤ 5ms, Instantaneous response times ≤ 100μs
Switching frequency	20kHz
Function setting	Compensate for harmonics only, compensate for reactive power only, compensate for both harmonics and reactive power
The frequency of harmonic compensation	2-51st
Self-loss	≤ 2.5%
Efficiency	≥ 97.5%
Total harmonic compensation rate	≥ 97%
Cooling method	Forced air cooling
Noise	≤ 60dB
Operating temperature	-10℃ ~ +45℃
Storage temperature	-25℃ ~ +60℃
Relative humidity	≤ 95% (No condensation)
Altitude	≤ 1000m
Protection level	IP20
Communication	RS485 (Modbus-RTU) or Ethernet (Modbus-TCP)
Module capacity	30A, 50A, 75A or 100A
Working mode	Automatic or manual
Overload protection	Automatic limit to rated current output

3. Structure

◆ Module

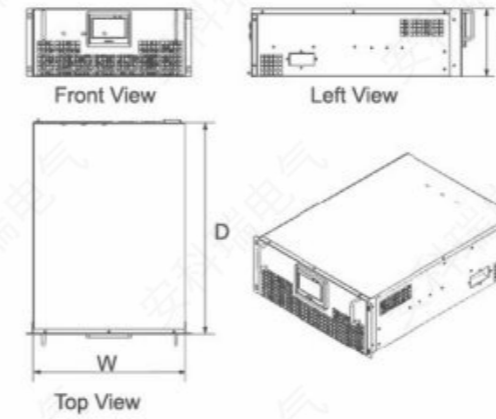

Active Power Filter	Module Size(W*D*H)(mm)	Weight(kg)
30A	480*440*130	25
50A	480*530*200	30
75A	450*622*201	35
100A	450*622*201	35
150A	500*533*280	50

◆ Wall-mounted

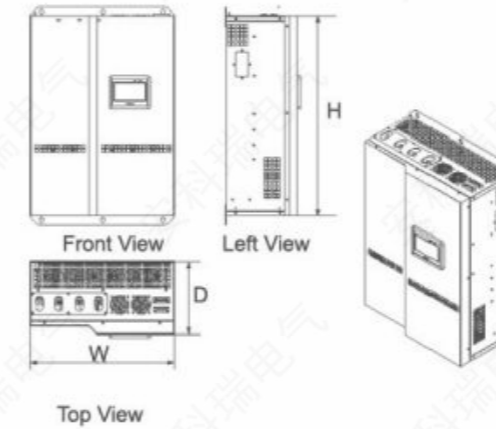

Active Power Filter	Module Size(W*D*H)(mm)	Weight(kg)
30A	480*130*440	25
50A	480*200*530	30
75A	450*201*622	35
100A	450*201*622	35
150A	500*280*533	50

4. Schematic

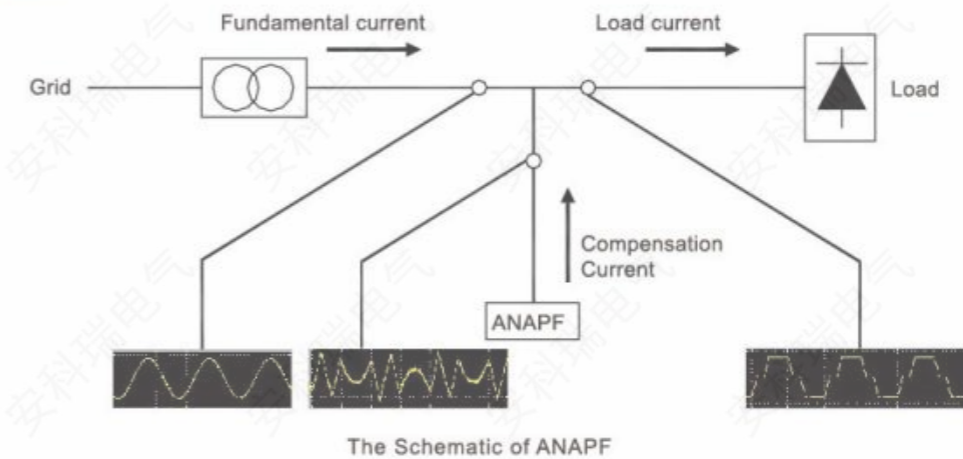

Monitoring Device

Power Sensor

1. AKH-0.66 Series Measurement Current Transformer

General

Current Transformer (CT) is used to transform high AC current to small easily manageable values. They are connected with the Panel Meter or Relay and they can help to measure the current or protect the equipments.

Standards

IEC/EN61869-1, IEC/EN61869-2

Security factor

FS<5

Rated frequency

50/60Hz

Maximum system voltage

720V AC

Test voltage

3kV AC(1min)

Rated short-time thermal current

$I_{th}=40\sim60I_n$

Rated dynamic current

$I_{dyn}=2.5I_{th}$

Continuous overload

120% I_n

Environment

Operating temperature: $-25^{\circ}\text{C}\sim+50^{\circ}\text{C}$

Storage temperature: $-40^{\circ}\text{C}\sim+80^{\circ}\text{C}$

Relative humidity, no condensation: 90%

Protection level

IP30

Accuracy

$\pm 3.0\%$, $\pm 1.0\%$, $\pm 0.5\%$, $\pm 0.2\%$

Burden

Ranging 0-30VA

Rated secondary current

X/5A(X/1A upon request)

Rated primary current

Ranging up to 6000A

Casing











Non-flammable, polycarbonate self extinguishing ABS



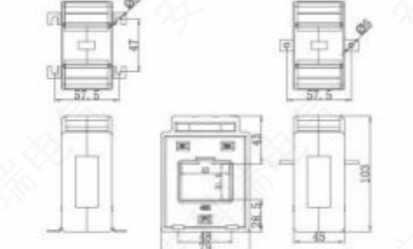

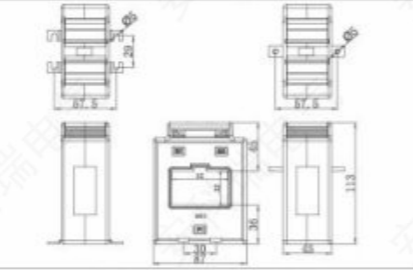



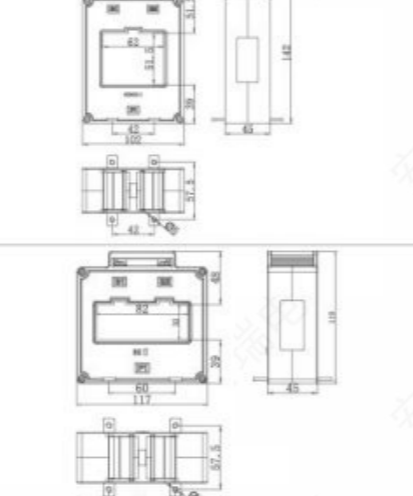





Terminal marks









Primary P1 and P2



Secondary S1 and S2



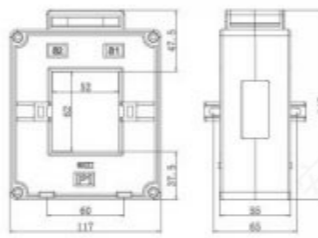

Type	Ratio (A)	Burden(VA)			Turns	Size(unit: mm)	
		Class 0.2	Class 0.5	Class 1.0			
30I	15/5(1)			1.5	5		
	20/5(1)			1.5	4		
	25/5(1)			1.5	3		
	30/5(1)			1.5	3		
	40/5(1)			1.5	2		
	50/5(1)			1.5	2		
	60/5(1)			1.5	2		
	75/5(1)			1.5	1		
	80/5(1)			1.5	1		
	100/5(1)			1.5	1		
	150/5(1)		2.5		1		
	200/5(1)		2.5		1		
250/5(1)		3.75		1			
300/5(1)		5		1			
400/5(1)		5		1			
500/5(1)		10		1			
600/5		10		1			
40I	150/5(1)			2.5	1		
	200/5(1)		2.5		1		
	250/5(1)		3.75		1		
	300/5(1)		5		1		
	400/5(1)		5		1		
	500/5(1)		10		1		
	600/5(1)		10		1		
	800/5(1)		10		1		
	1000/5(1)	10			1		
	500/5(1)		10		1		
600/5(1)		10		1			
800/5(1)		10		1			
1000/5(1)	10			1			
1200/5(1)	10			1			
1500/5(1)	20			1			
60I	2000/5(1)	20			1		
	2500/5(1)	30			1		
	1000/5(1)	10			1		
	1200/5(1)	10			1		
	1500/5(1)	20			1		
	2000/5(1)	20			1		
80I	2500/5(1)	30			1		
	3000/5(1)	30			1		
	1000/5(1)	10			1		
	1200/5(1)	10			1		
	1500/5(1)	20			1		

Type	Ratio (A)	Burden(VA)			Size(unit: mm)
		Class 0.2	Class 0.5	Class 1.0	
	100/5(1)			1.5	
	150/5(1)			1.5	
	200/5(1)		1.5		
	250/5(1)		3.75		
	300/5(1)		5		
	400/5(1)		5		
	500/5(1)		10		
	600/5(1)		10		
	300/5(1)		5		
	400/5(1)		5		
	500/5(1)		10		
	600/5(1)		10		
	800/5(1)		10		
	500/5(1)		10		
	600/5(1)		10		
	800/5(1)		10		
	1000/5(1)	10			
	1200/5(1)	10			
	500/5(1)		10		
	600/5(1)		10		
	800/5(1)		10		
	1000/5(1)	10			
	1200/5(1)	10			
	1500/5(1)	20			
	800/5(1)		10		
	1000/5(1)	10			
	1200/5(1)	10			
	1500/5(1)	20			
	2000/5(1)	20			
	2500/5(1)	30			
	1000/5(1)		10		
	1200/5(1)		10		
	1500/5(1)		20		
	2000/5(1)		20		
	2500/5(1)		30		
	3000/5(1)		30		
	3000/5(1)		30		

Type	Ratio (A)	Burden(VA)			Size(unit: mm)
		Class 0.2	Class 0.5	Class 1.0	
	1000/5(1)	10			
	1200/5(1)	10			
	1500/5(1)	20			
	2000/5(1)	20			
	2500/5(1)	30			
	3000/5(1)	30			
	3000/5(1)	30			
	1500/5(1)	20			
	2000/5(1)	20			
	2500/5(1)	30			
	3000/5(1)	30			
	1500/5(1)	20			
	2000/5(1)	20			
	2500/5(1)	30			
	3000/5(1)	30			
	3000/5(1)	30			
	1500/5(1)	20			
	2000/5(1)	20			
	2500/5(1)	30			
	3000/5(1)	30			
	4000/5(1)	30			
	4000/5(1)	30			
	1500/5(1)	20			
	2000/5(1)	20			
	2500/5(1)	30			
	3000/5(1)	30			
	4000/5(1)	30			
	5000/5(1)	30			
	1500/5(1)	20			
	2000/5(1)	20			
	2500/5(1)	30			
	3000/5(1)	30			
	4000/5(1)	30			
	5000/5(1)	30			
	1500/5(1)	20			
	2000/5(1)	20			
	2500/5(1)	30			
	3000/5(1)	30			
	4000/5(1)	30			
	5000/5(1)	30			

Type	Ratio (A)	Burden(VA)			Size(unit: mm)
		Class 0.2	Class 0.5	Class 1.0	
	1500/5(1)	20			
	2000/5(1)	20			
	2500/5(1)	30			
	3000/5(1)	30			
	4000/5(1)	30			
	2000/5(1)	20			
	2500/5(1)	30			
	3000/5(1)	30			
	4000/5(1)	30			
	5000/5(1)	30			
	2000/5(1)	20			
	2500/5(1)	30			
	3000/5(1)	30			
	4000/5(1)	30			
	5000/5(1)	30			
	2000/5(1)	20			
	2500/5(1)	30			
	3000/5(1)	30			
	4000/5(1)	30			
	5000/5(1)	30			

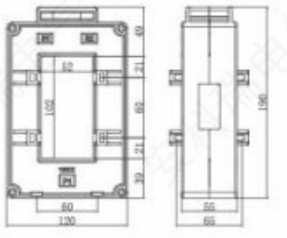
Type	Ratio (A)	Burden(VA)			Size(unit: mm)
		Class 0.2	Class 0.5	Class 1.0	
	200/5(1)		2.5		
	300/5(1)		2.5		
	400/5(1)		5		
	500/5(1)		10		
	600/5(1)		10		
	800/5(1)		10		
	1000/5(1)	10			
	1500/5(1)	15			
	2000/5(1)	20			
	500/5(1)		10		
	600/5(1)		10		
	800/5(1)		10		
	1000/5(1)		10		
				10	

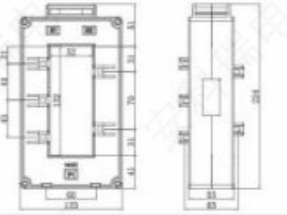
Type	Ratio (A)	Burden(VA)			Size(unit: mm)
		Class 0.2	Class 0.5	Class 1.0	
	1500/5(1)	15			
	2000/5(1)	20			
	2500/5(1)	30			
	3000/5(1)	30			
	1000/5(1)	10			
	1500/5(1)	15			
	2000/5(1)	20			
	2500/5(1)	20			
	3000/5(1)	30			
	2000/5(1)	20			
	2500/5(1)	30			
	3000/5(1)	30			
	4000/5(1)	30			
	5000/5(1)	30			

Type	Ratio (A)	Burden(VA)			Size(unit: mm)
		Class 0.2	Class 0.5	Class 1.0	
	5A/1.25mA		10		
	(10-20)A/5mA		10		
	(40-60)A/20mA		10		
	(20-50)A/10mA		10		
	(40-100)A/20mA		10		
	100A/40mA		10		
	(60-200)A/20mA		10		
	(100-250)A/40mA		10		
	400A/100mA		10		
	(100-200)A/10mA		10		
	(200-400)A/20mA		10		
	(300-600)A/100mA		10		
	400A/40mA		10		
	(150-200)/5(1)			1	
	(250-300)/5(1)			1.5	

Monitoring Device

Monitoring Device

Type	Ratio (A)	Burden(VA)			Size(unit: mm)
		Class 0.2	Class 0.5	Class 1.0	
K-Φ36	(300-400)/5(1)			1.5	
	(500-600)/5(1)		1.5		
K-Φ50	(600-700)/5(1)		2.5		
	(800-900)/5(1)		5		
K-60*40	1000/5(1)		10		
	400/5(1)		1.5		
	500/5(1)		2.5		
	600/5(1)		2.5		
	800/5(1)		2.5		
K-80*40	1500/5(1)		10		
	800/5(1)		5		
	1000/5(1)		10		
	1500/5(1)		10		
K-100*40	3000/5(1)	10			
	1500/5(1)		10		
	2000/5(1)		10		
	4000/5(1)		15		
K-120*60	5000/5(1)		10		
	2000/5(1)		10		
	3000/5(1)	10			
	4000/5(1)	10			
K-140*60	5000/5(1)		15		
	4000/5(1)		15		
	2000/5(1)		10		
K-160*80	5000/5(1)		15		
	4000/5(1)		15		
	3000/5(1)		10		
K-200*80	(4000-5000)/5(1)	15			
	(2500-3000)/5(1)	10			
	(1000-2000)/5(1)		10		

Type	Ratio (A)	Burden(VA)			Size(unit: mm)
		Class 0.2	Class 0.5	Class 1.0	
Z-3*Φ20	5-100/5			1.5	
	150/5			1.5	
	200/5			1.5	
	5-100/1			2.5	
	150/1		1.5		
	200/1		3.75		
Z-3*Φ15	5-200/0.05		5		
	5-100/0.02		5		
Z-3*Φ10	50/0.025		10		
	100-150/5		10		
Z-3*Φ35	200/5		10		
	250/5	10			
	300-450/5			1.5	
	500/5			1.5	
	600-800/5			1.5	
	1000-1250/5			2.5	
Z-3*Φ35	100-150/1		1.5		
	200/1		3.75		
	250/1		5		
	300-450/1		5		
	500/1		10		
	600-800/1		10		
1000-1250/1		10			

2. AHKC Series Hall Sensor

2.1 Open-loop hall current sensor

- Measuring
 - AC, DC, pulse and other complex current signals
- Features
 - Small package size
 - Low power consumption
 - Extended measuring range

• Application

- AC variable speed drives
- Battery supplied applications
- Uninterruptible Power Supplies

• Technical data

Technical parameters		Open-loop	
		Real-time values	Hall (true RMS)
Output	Nominal value	Voltage: $\pm 5V/\pm 4V$	Current: 4-20mA
	Zero offset voltage (current)	Voltage: $\pm 20mV$	Current: $\pm 0.05mA$
	Offset voltage (current) drift	Voltage: $\leq \pm 1.0mV/^{\circ}C$	Current: $\pm 0.04mA/^{\circ}C$
	Linearity	$\leq 0.2\%FS$	
Power voltage		DC $\pm 15V$ DC 12V/24V	DC 12V/24V
Bandwidth		0-20kHz	
Response time		$\leq 5\mu s$	$\leq 300ms$
Dielectric strength		Permissible 3500VAC between input/output	
Accuracy class		1.0	
Environment	Temperature	$-40^{\circ}C$ ~ $+85^{\circ}C$	
	Humidity	Up to 95%,no condensing	
	Altitude	$\leq 3500m$	

• Specifications

Appearance	Type	Rated input	Auxiliary Power	Rated Output	Measuring Aperture (mm)	
	AHKC-EKA	0~(50-500)A	$\pm 15V$	5V/4V	$\phi 20$	Split
	AHKC-EKAA	DC 0~(50-500)A	12V/24V	4-20mA		Split
	AHKC-EKDA	AC 0~(50-500)A	12V/24V	4-20mA	$\phi 20$	Split
	AHKC-EKB	0~(200-1000)A	$\pm 15V$	5V/4V	$\phi 40$	Split

Appearance	Type	Rated input	Auxiliary Power	Rated Output	Measuring Aperture (mm)	
	AHKC-EKBA	DC0~(200-1000)A	12V/24V	4-20mA	$\phi 40$	Split
	AHKC-EKBDA	AC0~(200-1000)A	12V/24V	4-20mA	$\phi 40$	Split
	AHKC-EKC	0~(500-1500)A	$\pm 15V$	5V/4V	$\phi 55$	Split
	AHKC-EKCA	DC0~(500-1500)A	12V/24V	4-20mA	$\phi 55$	Split
	AHKC-EKCDA	AC0~(500-1500)A	12/24V	4-20mA	$\phi 55$	Split
	AHKC-K	0~(400-2000)A	$\pm 15V$	5V/4V	64x16	Split
	AHKC-KAA	DC0~(400-2000)A	12V/24V	4-20mA	64x16	Split
	AHKC-KDA	AC0~(400-2000)A	12V/24V	4-20mA	64x16	Split
	AHKC-H	0~(500-3000)A	$\pm 15V$	5V/4V	82x32	Split
	AHKC-KA	0~(500-5000)A	$\pm 15V$	5V/4V	104x36	Split
	AHKC-HB	0~(2000-8000)A	$\pm 15V$	5V/4V	132x52	Split
		0~(10000-20000)A	$\pm 15V$	5V/4V	132x52	
	AHKC-HBAA	DC0~(2000-8000)A	12V/24V	4-20mA	132x52	
	DC0~(10000-20000)A	12V/24V	4-20mA	132x52		
	AHKC-HBDA	AC0~(2000-8000)A	12V/24V	4-20mA	132x52	Split
		AC0~(10000-20000)A	12V/24V	4-20mA	132x52	
	AHKC-E	0~(200-500)A	$\pm 15V$	5V/4V	$\phi 20$	closed
	AHKC-EA	0~(200-1000)A	+15V	5V/4V	$\phi 40$	closed
	AHKC-EB	0~(500-1500)A	+15V	5V/4V	$\phi 60$	closed

Appearance	Type	Rated input	Auxiliary Power	Rated Output	Measuring Aperture (mm)	
	AHKC-LT	0~(100-800)A	±15V	5V/4V	Φ32.5	closed
	AHKC-C	0~(100-800)A	±15V	5V/4V	31×13	closed
	AHKC-BS	0~(50-500)A	±15V	5V/4V	20.5×10.5	closed
	AHKC-BSA	DC0~(50-500)A	12V/24V	4-20mA	20.5×10.5	closed
	AHKC-F	0~(200-1000)A	±15V	5V/4V	43×13	closed
	AHKC-FA	0~(200-1500)A	±15V	5V/4V	52×15	closed
	AHKC-HAT	0~(400-2000)A	±15V	5V/4V	52×32	closed

Size	Specification	Outline size			Through size			Mounting size		Figure
		W	H	D	a	e	Φ	M	N	
	AHKC-H	149	79	25	82	32	/	/	46	Fig.2
	AHKC-KA	176	95.5	29	104	36	/	/	60	Fig.2
	AHKC-HB	204	111.5	29	132	52	/	/	48×2	Fig.2
	AHKC-HBAA	204	111.5	29	132	52	/	/	48×2	Fig.2
	AHKC-HBDA	204	111.5	29	132	52	/	/	48×2	Fig.2

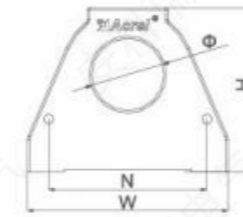

Fig.3



Fig.4

• Spec. and size (unit: mm)

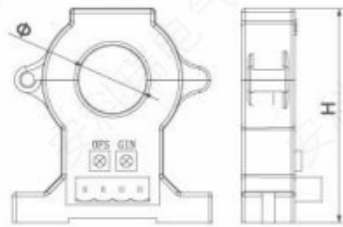
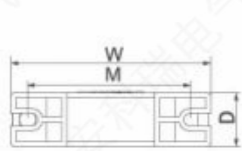

Fig.1

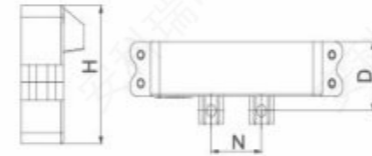
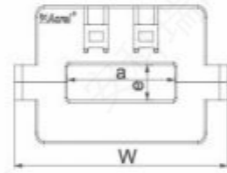

Fig.2

Size	Specification	Outline size			Through size			Mounting size		Figure
		W	H	D	a	e	Φ	M	N	
	AHKC-EKA	60	64	16	/	/	20	47	/	Fig.1
	AHKC-EKAA	60	64	16	/	/	20	47	/	Fig.1
	AHKC-EKDA	60	64	16	/	/	20	47	/	Fig.1
	AHKC-EKB	100	102	24	/	/	40	80	/	Fig.1
	AHKC-EKBA	100	102	24	/	/	40	80	/	Fig.1
	AHKC-EKBDA	100	102	24	/	/	40	80	/	Fig.1
	AHKC-EKC	115	110	27	/	/	55.5	95.5	/	Fig.1
	AHKC-EKCA	115	110	27	/	/	55.5	95.5	/	Fig.1
	AHKC-EKDA	115	110	27	/	/	55.5	95.5	/	Fig.1
	AHKC-K	127	63	25	64	16	/	/	30	Fig.2
	AHKC-KAA	127	63	25	64	16	/	/	30	Fig.2
	AHKC-KDA	127	63	25	64	16	/	/	30	Fig.2

Size	Specification	Outline size			Through size			Mounting size		Figure
		W	H	D	a	e	Φ	M	N	
	AHKC-E	53	72	16	/	/	21	47	/	Fig.3
	AHKC-LT	90	73.5	25	/	/	32.5	74.5	71	Fig.3
	AHKC-EA	100	108	30	/	/	40	78	/	Fig.3
	AHKC-EB	120	112	30	/	/	60	98	/	Fig.3
	AHKC-C	59	44	19	31	13	/	/	/	Fig.4
	AHKC-BS	43	32.5	19	20.5	10.5	/	/	/	Fig.4
	AHKC-BSA	43	32.5	19	20.5	10.5	/	/	/	Fig.4
	AHKC-F	74	57	22	43	13	/	/	22	Fig.4
	AHKC-FA	94	60.5	26.5	52	15	/	83	28	Fig.4
	AHKC-HAT	94	76.5	24	52.5	32	/	83	28	Fig.4

➤ 2.2 Closed-loop hall current sensor

• Measuring

-AC, DC, pulse and other complex current signals

• Features

- Excellent accuracy
- Low temperature drift
- Wide frequency bandwidth
- Optimized response time

• Application

- AC variable speed drives
- Battery supplied applications
- Uninterruptible Power Supplies
- Power supplies for welding application

• Technical data

Technical parameters		Data	
		Closed-loop	
		Hall Current	Hall Voltage
Output	Nominal value	Current: 50mA, 100mA, 200mA, 200mA	Current: 50mA
	Zero offset voltage (current)	Voltage: $\pm 0.2\text{mA}$	Current: $\pm 0.1\text{mA}$
	Linearity	$\leq 0.2\%FS$	
Power voltage		$\pm 15\text{V} \sim \pm 24\text{V}$	
Bandwidth		0-100kHz	
Response time		$\leq 1\mu\text{s}$	$\leq 200\mu\text{s}$
Dielectric strength		3.5kV AC	12kV AC
Accuracy class		0.5	
Environment	Temperature	$-40^{\circ}\text{C} \sim +85^{\circ}\text{C}$	
	Humidity	Up to 95%, no condensing	
	Altitude	$\leq 3500\text{m}$	

• Specifications

Appearance	Type	Rated Input	Auxiliary Power	Rated Output	Measuring Aperture (mm)
	AHBC-LTA	(100~300)A	$\pm 15\text{V}$	50mA/100mA	$\Phi 20$

Appearance	Type	Rated Input	Auxiliary Power	Rated Output	Measuring Aperture (mm)
	AHBC-LT1005	$\pm 1000\text{A}$	$\pm 15\text{V} \sim \pm 24\text{V}$	200mA	$\phi 40.5$
	AHBC-LF	$\pm 2000\text{A}$	$\pm 15\text{V} \sim \pm 24\text{V}$	400mA	$\phi 60.5$

• Spec. and Size (unit: mm)

Outline size of AHBC-LTA

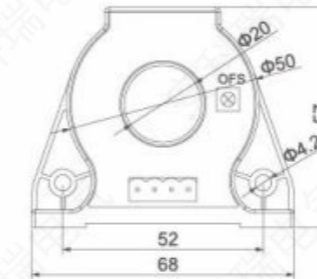

Outline size of AHBC-LT1005

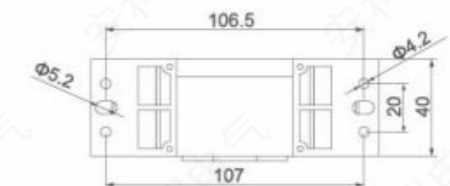
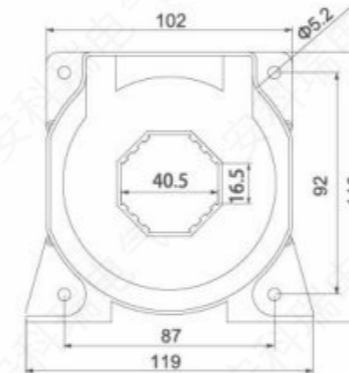

Outline size of AHBC-LF

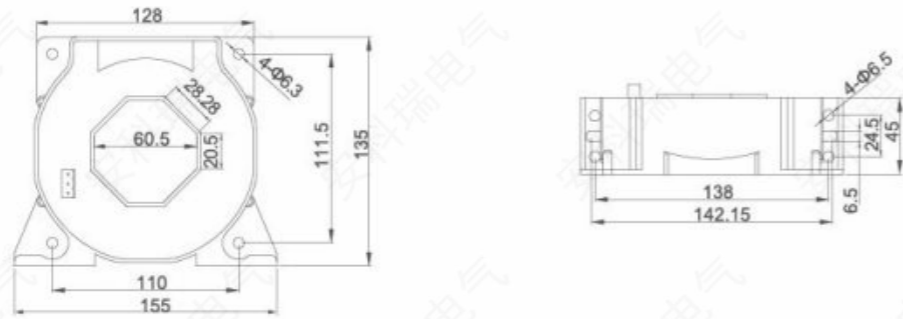

2.3 DC voltage sensor

Appearance	Type	Rated Input	Auxiliary Power	Rated Output	Measuring Aperture (mm)
	ACTDS-DV	100-1500V	12V/15V/24V	4~20mA or 5V	/
	AHVS-L100	50-2500V	±15V~±24V	50mA	/
	AHVS-LV	100-4000V	±15V~±24V	50mA	/

• Spec. and Size (unit: mm)

Outline size of ACTDS-DV

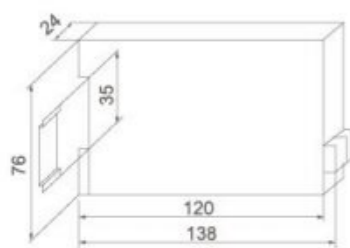

Outline size of AHVS-L100

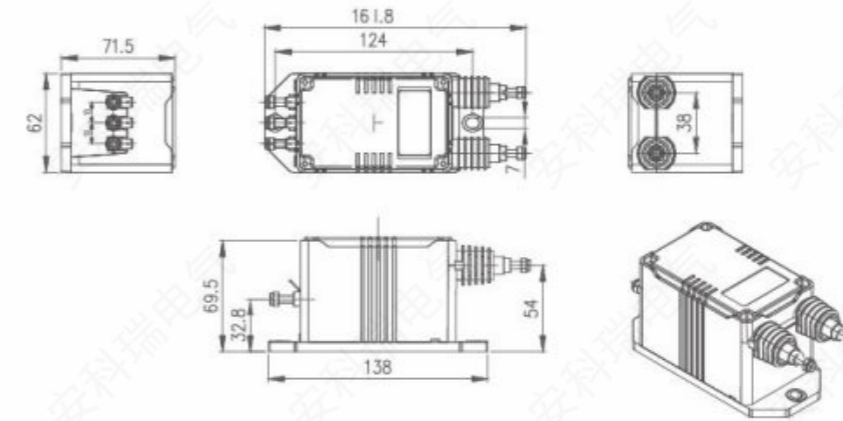

Outline size of AHVS-LV

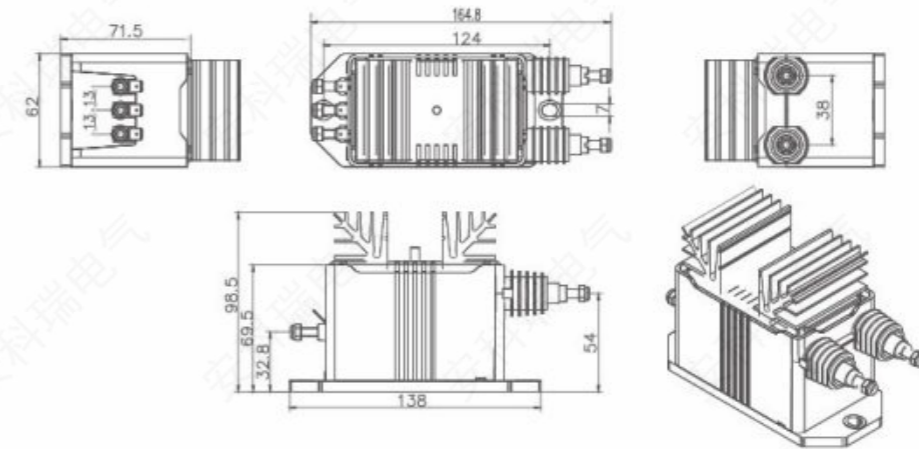

2.4 DC leakage current sensor

Appearance	Type	Rated Input	Auxiliary Power	Rated Output	Measuring Aperture (mm)
	AHLCLTA	10mA~2A	±15V	5V	φ20
	AHLCEA	10mA~2A	±15V	5V	φ40

Appearance	Type	Rated Input	Auxiliary Power	Rated Output	Measuring Aperture (mm)
	AHLC-EB	10mA~2A	±15V	5V	φ60

• Spec. and size (unit: mm)

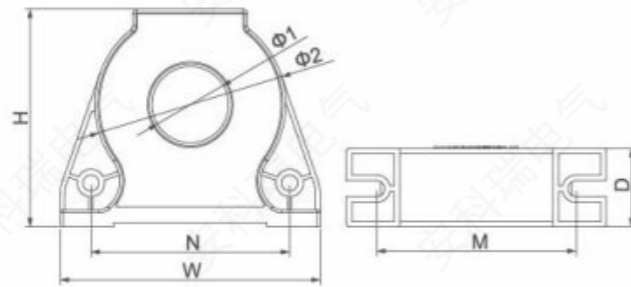

Size	Specification	Outline size			Through size	Mounting size		
		W	H	D	Φ2	Φ1	M	N
AHLC-LTA		68	57	20	50	20	52	52
AHLC-EA		100	108	30	75	40	78	/
AHLC-EB		120	112	30	94	60	98	/

3. BA Series Electrical Transducer

3.1 BA Current Transducer

• Model Description

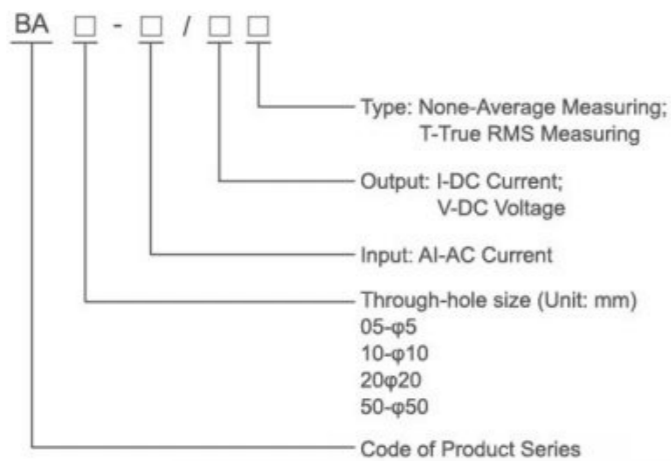

• Technical Parameter

◆ Measuring

- Direct AC Current measurement up to 600A
- Measurement of leakage currents
- Overload : 1.2 times of rated value

◆ Application

- Industrial automation

◆ Specifications



		BA05-AI/I(V)	BA10-AI/I(V)	BA20-AI/I(V)	BA50-AI/I(V)	BA50L-AI/I(V)
Auxiliary Power	DC 12V	□	□	□	□	□
	DC24V	□	□	□	□	□
Consumption		≤1W	≤1W	≤1W	≤1W	≤1W
Through-hole size		Φ5mm	Φ10mm	Φ20mm	Φ50mm	Φ50mm
Input	Current	AC 0~(0.5~10)A	AC 0~(8~50)A	AC 0~(40~200)A	AC 0~(60~600)A	AC 0~(0.1~1)A (limitation of leakage currents)
	Output	Nominal value: DC4~20mA, or 0~20mA, 0~5V, 0~10V etc				
Load resistance		Current output≤500Ω, Voltage output≥1kΩ				
Accuracy Class		0.5%				
Response time		≤350ms				
Temperature		Operation:-10 to +55°C Storage:-25 to +70°C				
Temperature coefficient		≤200ppm/°C				
Installation		(Rail)DIN35, fix on cubicle with screws				
Standards		idt IEC 688:1992				

• Wiring

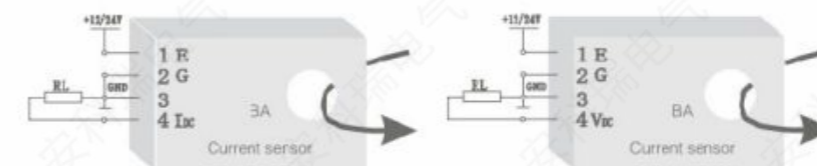

3.2 Intelligent BA Current Transducer

Model Description

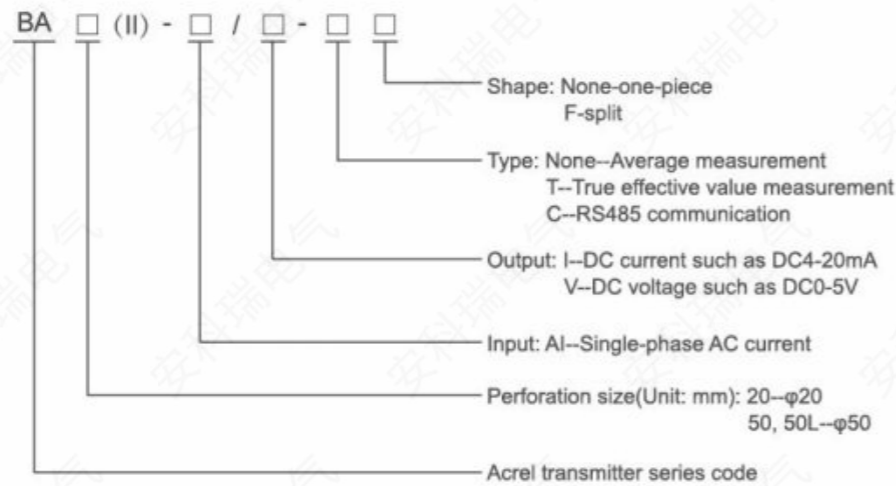

Technical Parameter

Measuring

- Direct AC Current measurement up to 600A
- Measurement of leakage currents
- Overload: 1.2 times of rated values

Characteristic

- One-piece shape
- Split-type shape
- RS485 interface

Application

Industrial automation

Specifications



Technical parameter		Index
Accuracy class		Class 0.5
Input	Nominal value	BA20(II)-AI Current AC 0.5A, 50A, 200A, etc. AC 0~(0.5~200)A
		BA50(II)-AI Current AC 60A, 300A, 600A, etc. AC 0~(60~600)A
		BA50L(II)-AI Current AC 0.1A, 1A, etc. AC 0~(0.1~1)A
	Overload	Continuous 1.2 times, instantaneous current 10 times/1S
Absorbed power		≤1VA
Frequency response		25Hz~800Hz, especially suitable for industrial frequency occasions
Output	Nominal value	DC4~20mA, or 0~20mA, 0~5V, 0~10V ^① etc.
	Load Resistance	When DC12V power supply, current output is ≤250Ω When DC24V power supply, current output is ≤500Ω, When voltage output is ≥1KΩ
	Communication	RS485 interface/Modbus-RTU ^②
Response time		≤400ms
Power supply	Voltage	DC 12V or 24V
	Power consumption	≤1W
Insulation resistance		>100MΩ
Compressive strength		Between input/output and power supply 2.0KV/1min, 50Hz
Temperature Coefficient		-10°C~+55°C, ≤400ppm/°C
Environment	Temperature	Work: -10°C~+55°C Storage: -25°C~+70°C
	Humidity	≤93%RH, no condensation, no corrosive gas place
	Altitude	≤2000m
Installation method		TS35 rail, or use screws to fix the cabinet

Note: ①0~10V output is only suitable for DC24V power supply;

②The communication function is optional.

Wiring

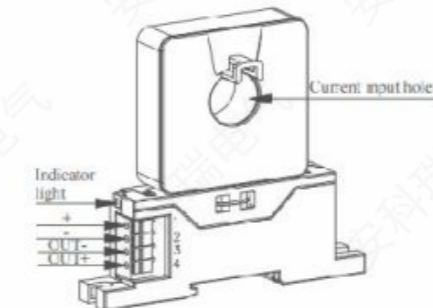

- 1 — + The positive pole of the power supply (note that the positive pole and the negative pole of the power supply cannot be reversed)
- 2 — - Negative power supply
- 3 — OUT- Analog output negative
- 4 — OUT+ analog output positive

4. BD Series Electrical Transducer

Model Description

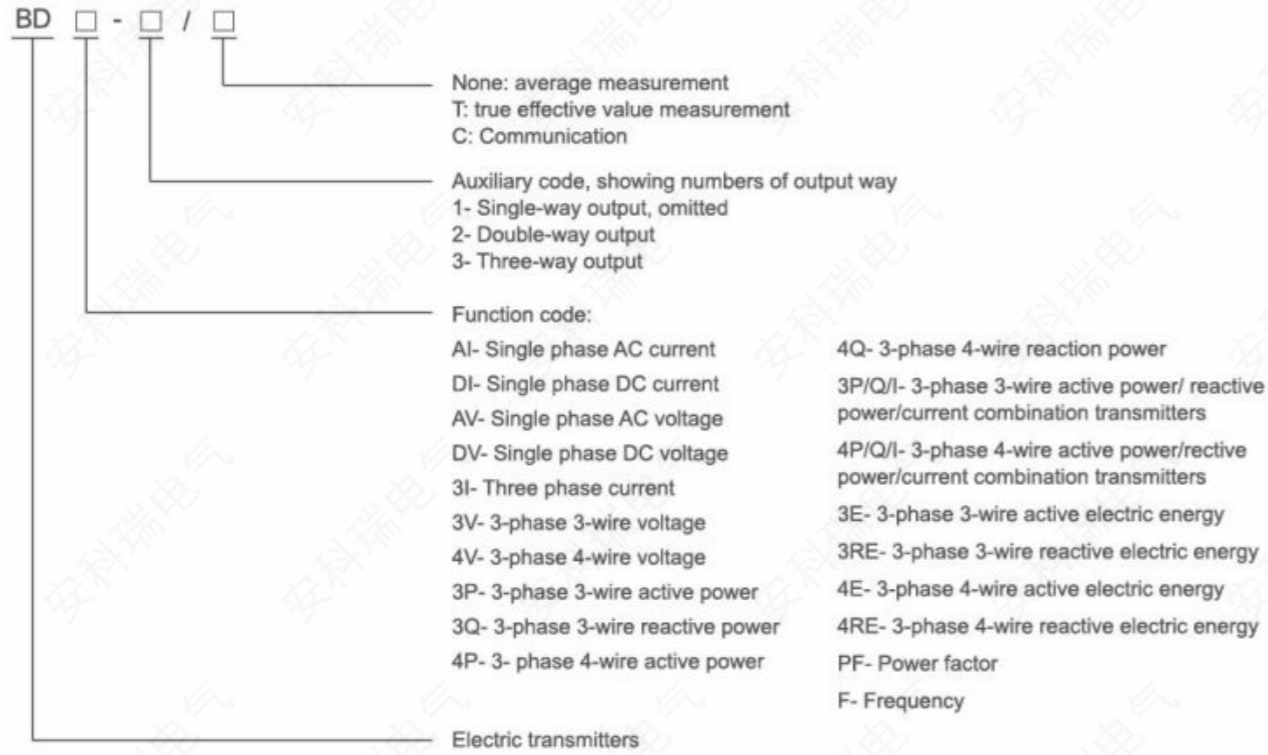

Technical Parameter

Measuring

- Voltage\Current\Power\Power factor\Frequency
- Measurement of leakage currents
- Overload : 1.2 times of rated value

Communication

- Interface:RS485
- Protocol:Modbus-RTU

Output

Analog Output: DC 0-5V/0-10V/0-20mA/4-20mA

Application

- Power Monitoring

Specifications



		BD-AI BD-AV	BD-3I3 BD-3(4)V3	BD-3(4)P BD-3(4)Q	BD-3(4)E	
Phase & Wiring	1P2W	■	□	□	□	
	3P3W	—	□	□	□	
	3P4W	—	□	□	□	
Input	Voltage	Direct L-L	Up to 480V AC			
		Direct L-N	Up to 276V AC			
	Current	With external PT	■	■	■	■
		Direct	Up to 5AAC			
Measuring	With external CT	■	■	■	■	
	Voltage	□	□			
	Current	□	□	□	□	
	Active/Reactive Power	—	—	□	□	
	Apparent Power	—	—	□	□	
	Power Factor	—	—	□	□	
Energy Metering	Frequency	—	—	□	□	
	±KWh	—	—	—	□	
Accuracy Class	0.5%					
Communication	Interface:RS485 Protocol:Modbus-RTU	□	□	□	□	
Analog Output	DC 0-5V,0-10V,0-20mA,4-20mA					
Pulse Output		—	—	—	■	
Dimensions(mm)	Housing(W×H×D)	138×76×24	112×110×75	112×110×75	112×110×75	
Auxiliary Power	85-265V AC/DC,DC24V,DC48V					
Temperature	Operation	-10 to 55°C				
	Storage	-25 to 70°C				
Humidity	Up to 95%,no condensing					
Installation	(Rail)DIN35 , fix on cubicle with screws					
Standards	idt IEC 688:1992					

MOTE: "■":Yes "—" :No "□":Optional

• Wiring

(1) BD-AI、BD-DI、BD-AV、BD-DV、BD-AI/C

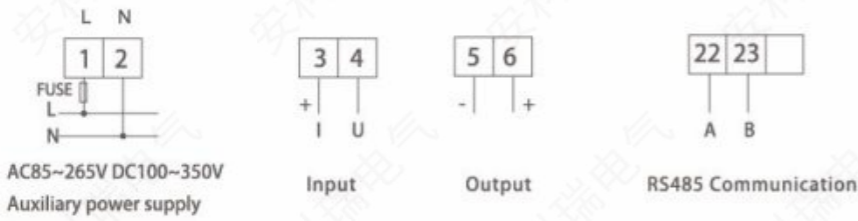
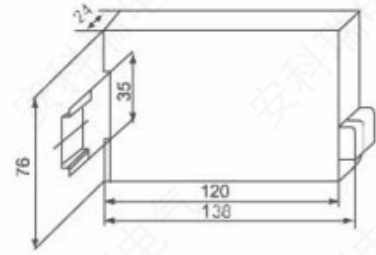

(2) BD-3I3、BD-3V3、BD-4V3

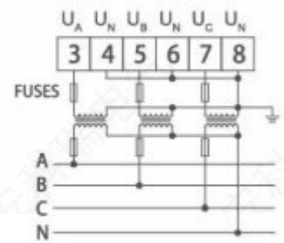

Voltage(three-phase 4-wire 3PT)

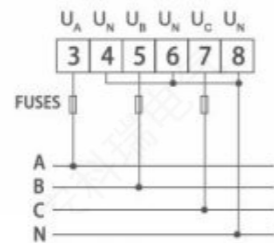

Voltage(three-phase 4-wire no-PT)

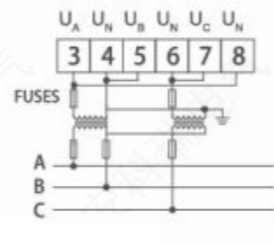

Voltage(three-phase 3-wire 2PT)

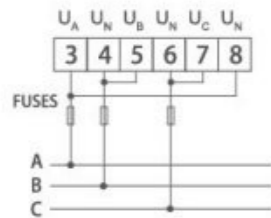

Voltage(three-phase 3-wire no-PT)

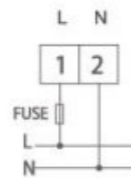

AC85-265V DC100-350V
Auxiliary power supply

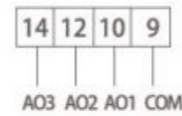

Analog output

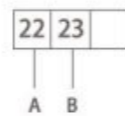

RS485 Communication

Voltage transmitters

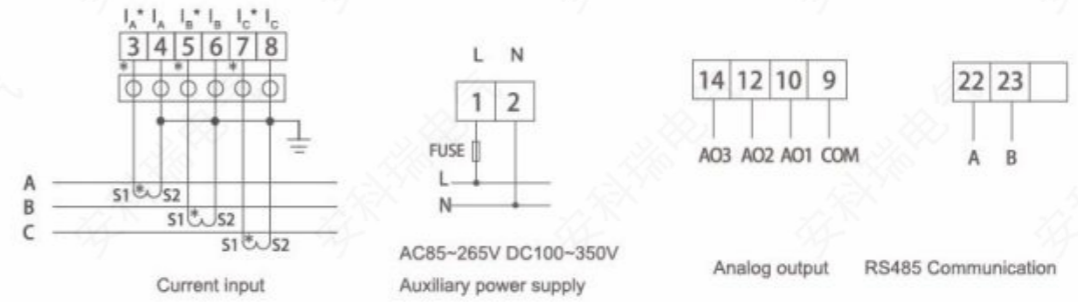

Current transmitters

(3) BD-3P、BD-3Q、BD-3P/Q/I、BD-4P/Q/I、BD-4P、BD-4Q

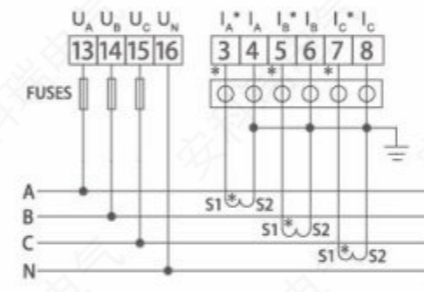
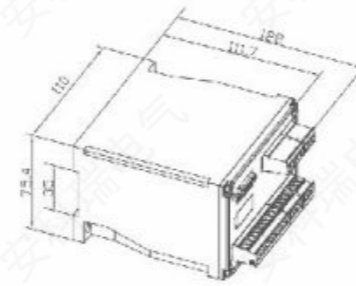

Three-phase 4-wire 3CT

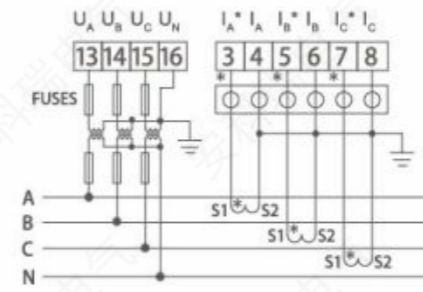

Three-phase 4-wire 3PT,3CT

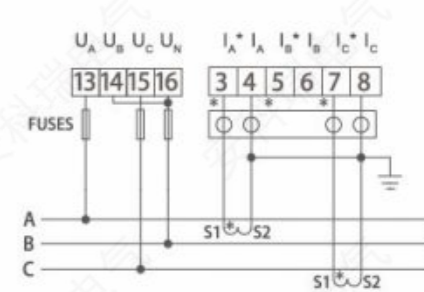

Three-phase 3-wire 2CT

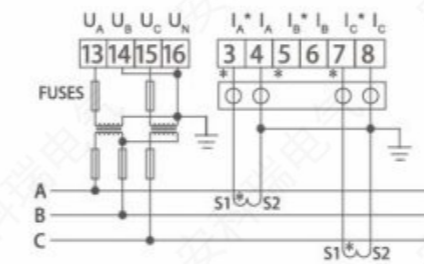

Three-phase 3-wire 2PT,2CT

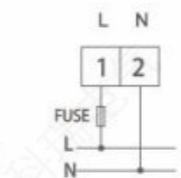

Auxiliary power supply



P/Q/I Analog output

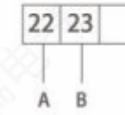

RS485 Communication

(4) BD-3E、BD-4E、BD-4EA

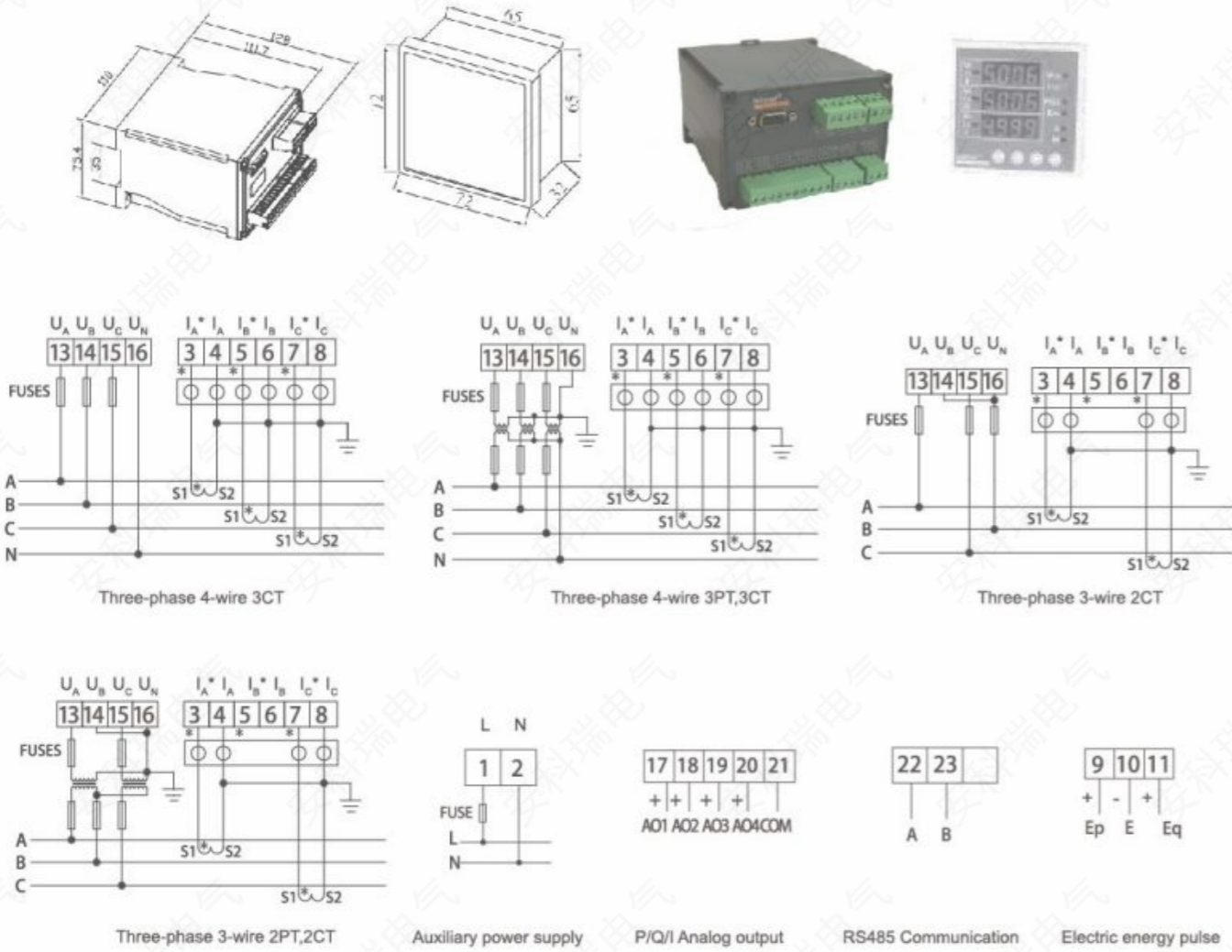

• Technical Parameter

Input form	Input range	Output range	Auxiliary supply	Isolation voltage	Output settings	Other features	Model
Direct current	4-20mA	4-20mA	/	2kV	2-wire 8.5-40VDC	Powered by output circuit	BM-DI/IS
Alternating current	0-1A 0-5A	4-20mA	/	2kV	2-wire 8.5-40VDC	Powered by output circuit	BM-AI/IS
	4-20mA	4-20mA	/	2kV	Self-powered by input circuit		BM-DIS/I
Direct current	4-20mA 0-5V	4-20mA	24VDC	2kV	Independent two circuits		BM-DI/II BM-DV/II BM-DI/IV BM-DV/IV
	4-20mA 0-20mA	4-20mA 0-20mA	24VDC	2kV	4-wire		BM-DI/I BM-DI/V
	0-20mA	Two relays controlled by setting point	110/220V AC, DC	2kV	2 NO contact groups		BM-DI/J
Direct voltage	0-10V; 0-5V	4-20mA	/	2kV	2-wire 8.5-40VDC	Powered by output circuit	BM-DV/IS
	0-10V; 0-5V	4-20mA 0-20mA	24VDC	2kV	4-wire		BM-DV/I BM-DV/V
	0-10V	Two relays controlled by setting point	110/220V AC, DC	2kV	2 NO contact groups		BM-DV/J
Alternating voltage	0-125V AC 0-250V AC 0-450V AC	4-20mA	/	2kV			
Thermal resistance	Pt100 0-50℃; 0-100℃; 0-150℃; 0-200℃ 0-250℃; 0-300℃	4-20mA 0-20mA	/	2kV	2-wire 8.5-40VDC	Powered by output circuit	BM-TR/IS
			24VDC	2kV	4-wire		BM-TR/I
Resistance	0-100Ω; 0-1kΩ 0-5kΩ; 0-10kΩ	4-20mA	/	2kV	2-wire 8.5-40VDC	Powered by output circuit	BM-R/IS
Potentiometer	0-350Ω(-10kΩ)	4-20mA	/	2kV	2-wire 8.5-40VDC	Powered by output circuit	BM-VR/IS

» 5. BM Series Analog Signal Isolator

• Model Description

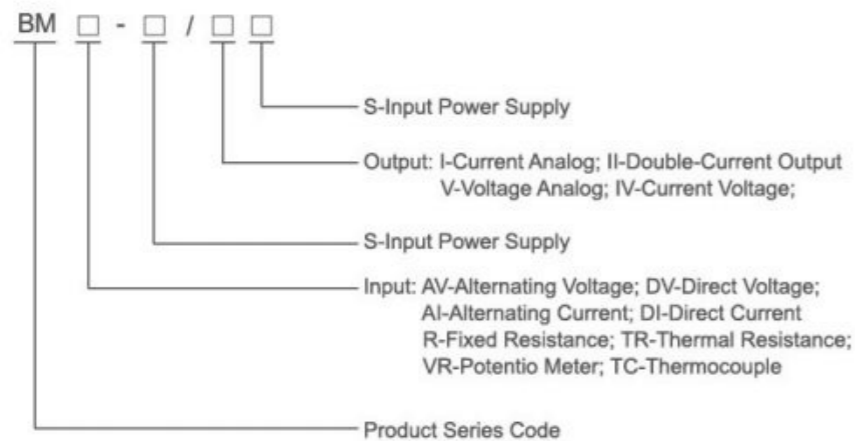

Wiring

(1) BM-DI/IS; BM-DV/IS

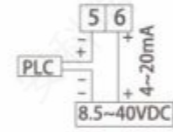
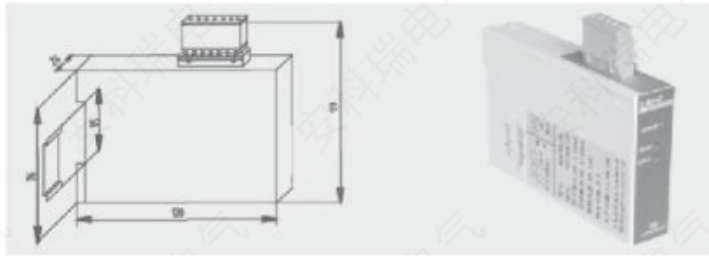

Output



Input

(2) BM-DI/II; BM-DV/II; BM-DI/VI; BM-DV/VI

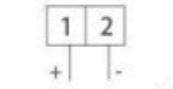
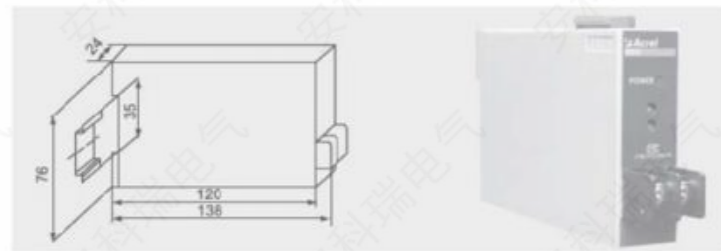

DC24V or
AC/DC220V
Auxiliary supply

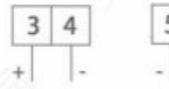

DC4-20 mA
or DC 0-5V
Input

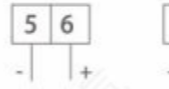

DC4-20 mA
or DC 0-5V
Output 1

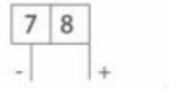

DC4-20 mA
or DC 0-5V
Output 2

(3) BM-DI/I; BM-DI/V; BM-DV/I; BM-DV/V

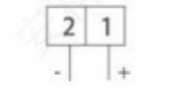
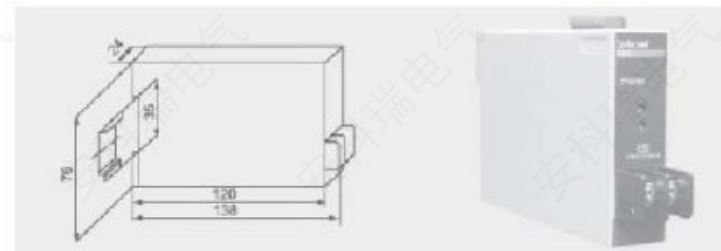

DC24V
Auxiliary supply

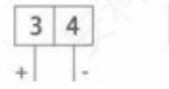

Input

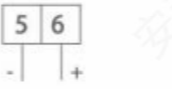

Output

(4) BM-DIS/I

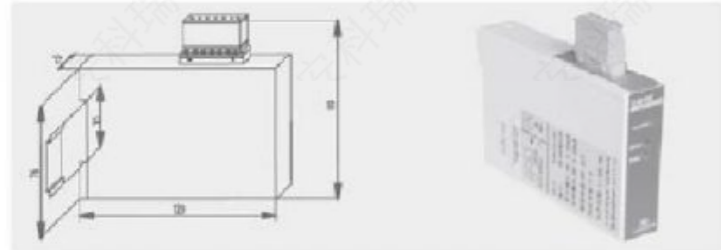

4-20mA
Input

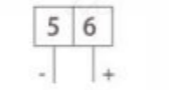

4-20mA
Output

(5) BM-AI/IS

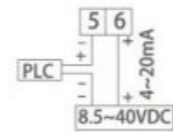

Output

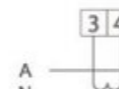

Input

(6) BM-AV/IS

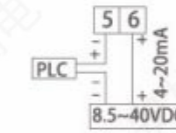
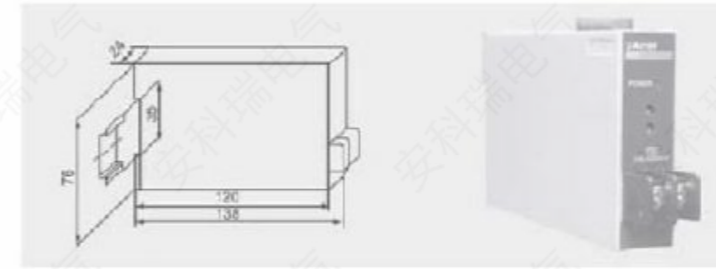

Output

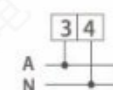

Input

(7) BM-TC/I; BM-TC/V

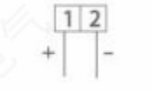

Auxiliary supply



Input



Output

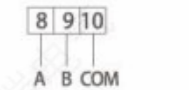

Communication

(8) BM-TR/IS; BM-TR/I; BM-TR/V

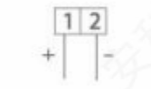
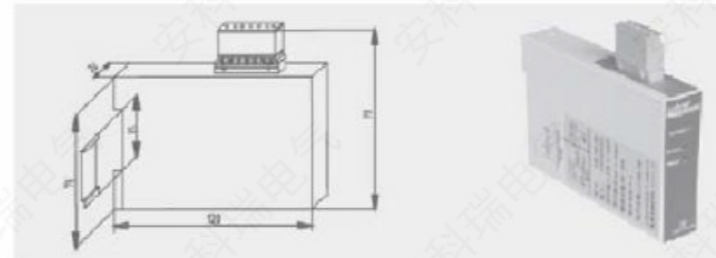

Auxiliary supply

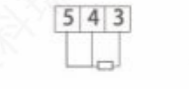

BM-TR/IS
3-wire RTD input

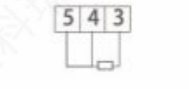

2-wire RTD input

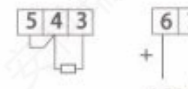

4-20mA
Output

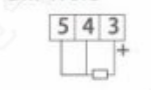

3-wire RTD input



2-wire RTD input

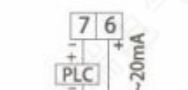

Output

(9) BM-R/IS

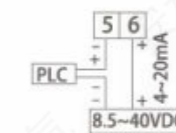
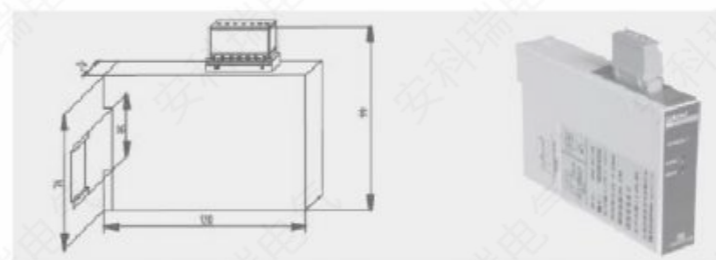

Output



Input

(10) BM-VR/IS

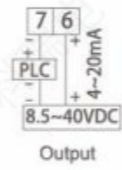
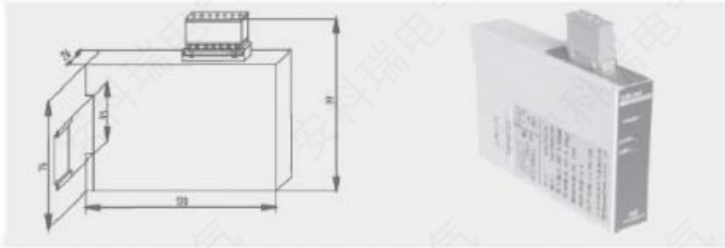

(11) BM-DI/J; BM-DV/J

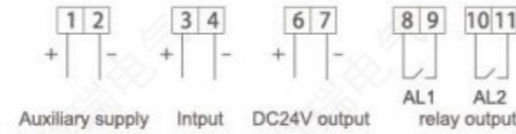

(12) BM-TR/J

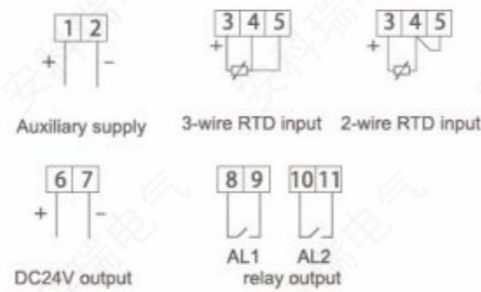

Power Monitoring and Controlling

1.AMC Series Programmable Power Meter

1.1 AC Ammeter&Voltmeter

Model Description

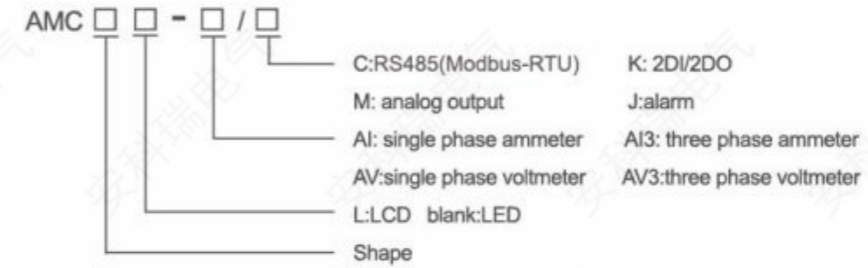

Shape	Panel size(mm)	Cut-out(mm)	Depth(mm)
48	49*49	45*45	93
72	75*75	67*67	94.3
96	96*96	92*92	77.8

Technical Parameter

Technical Parameter		Value
Input	Rated value	Voltage: AC100V, 220V or 380V, current: AC1A or 5A
	Overload	Voltage:1.2 times rated value(continuous); 2 times rated value(1 second) Current: 1.2 times rated value(continuous); 10 times rated value (1 second)
	Frequency	45Hz~65Hz
	Power consumption	<0.5VA
Accuracy		Class 0.5
Function	Display	LED or LCD
	Communication	RS485(Modbus-RTU)
	Alarm	1 channel passive relay , contact capacity 3A/30VDC, 3A/250VAC
	Analog output	DC4~20mA(load < 500Ω)
Switching	Input	4 channels or 2 channels passive contact Input
	Output	2 channels switching output, NO relay contact, capacity 3A/30VDC, 3A/250VAC
Auxiliary power supply	Voltage range	AC/DC 85~265V
	Power consumption	<5VA
Insulation resistance		≥100MΩ
Environment	Temperature	Operating:-10°C~+55°C Storage: -25°C ~+70°C
	Humidity	≤93%(no condensation)
	Altitude	≤2500m

Product Functions

Shape	Type	Function	Option	Option Group
	AMC48-AI	<ul style="list-style-type: none"> Single phase ammeter Display: LED Input: AC 1A or 5A 	/C: RS485(Modbus-RTU) /M: 1 analog output (programmable 4-20mA)	/
	AMC48L-AI	<ul style="list-style-type: none"> Single phase ammeter Display: LCD Input: AC 1A or 5A 	/C: RS485(Modbus-RTU) /M: 1 analog output (programmable 4-20mA)	/
	AMC48-AI3	<ul style="list-style-type: none"> Three phase ammeter Display: LED Input: AC 1A or 5A 	/	/
	AMC48L-AI3	<ul style="list-style-type: none"> Three phase ammeter Display: LCD Input: AC 1A or 5A 	/	/
	AMC48-AV	<ul style="list-style-type: none"> Single phase voltmeter Display: LED Input: AC 100V, 220V or 380V 	/C: RS485(Modbus-RTU) /M: 1 analog output (programmable 4-20mA)	/
	AMC48L-AV	<ul style="list-style-type: none"> Single phase voltmeter Display: LCD Input: AC 100V, 220V or 380V 	/C: RS485(Modbus-RTU) /M: 1 analog output (programmable 4-20mA)	/
	AMC48-AV3	<ul style="list-style-type: none"> Three phase voltmeter Display: LCD Input: AC 100V, 220V or 380V 	/	/
	AMC48L-AV3	<ul style="list-style-type: none"> Three phase voltmeter Display: LCD Input: AC 100V, 220V or 380V 	/	/
	AMC72-AI	<ul style="list-style-type: none"> Single phase ammeter Display: LED Input: AC 1A or 5A 	/C: RS485(Modbus-RTU) /M: 1 analog output (programmable 4-20mA) /K: 2DI/2DO /J: Alarm	1.KC 2.CJM
	AMC72L-AI	<ul style="list-style-type: none"> Single phase ammeter Display: LCD Input: AC 1A or 5A 	/C: RS485(Modbus-RTU) /M: 1 analog output (programmable 4-20mA) /K: 2DI/2DO /J: Alarm	1.KC 2.CJM
	AMC72-AI3	<ul style="list-style-type: none"> Three phase ammeter Display: LED Input: AC 1A or 5A 	/C: RS485(Modbus-RTU) /M: 1 analog output (programmable 4-20mA) /K: 2DI/2DO /J: Alarm	1.KC 2.CJM
	AMC72L-AI3	<ul style="list-style-type: none"> Three phase ammeter Display: LCD Input: AC 1A or 5A 	/C: RS485(Modbus-RTU) /M: 1 analog output (programmable 4-20mA) /K: 2DI/2DO /J: Alarm	1.KC 2.CJM

Shape	Type	Function	Option	Option Group
	AMC72-AV	<ul style="list-style-type: none"> Single phase voltmeter Display: LED Input: AC 100V, 220V or 380V 	/C: RS485(Modbus-RTU) /M: 1 analog output (programmable 4-20mA) /K: 2DI/2DO /J: Alarm	1.KC 2.CJM
	AMC72L-AV	<ul style="list-style-type: none"> Single phase voltmeter Display: LCD Input: AC 100V, 220V or 380V 	/C: RS485(Modbus-RTU) /M: 1 analog output (programmable 4-20mA) /K: 2DI/2DO /J: Alarm	1.KC 2.CJM
	AMC72-AV3	<ul style="list-style-type: none"> Three phase voltmeter Display: LED Input: AC 100V, 220V or 380V or 660V 	/C: RS485(Modbus-RTU) /M: 1 analog output (programmable 4-20mA) /K: 2DI/2DO /J: Alarm	1.KC 2.CJM
	AMC72L-AV3	<ul style="list-style-type: none"> Three phase voltmeter Display: LCD Input: AC 100V, 220V or 380V 	/C: RS485(Modbus-RTU) /M: 1 analog output (programmable 4-20mA) /K: 2DI/2DO /J: Alarm	1.KC 2.CJM
	AMC96-AI	<ul style="list-style-type: none"> Single phase ammeter Display: LED Input: AC 1A or 5A 	/C: RS485(Modbus-RTU) /M: 1 analog output (programmable 4-20mA) /K: 2DI/2DO /J: Alarm	1.KC 2.CJM
	AMC96L-AI	<ul style="list-style-type: none"> Single phase ammeter Display: LCD Input: AC 1A or 5A 	/C: RS485(Modbus-RTU) /M: 1 analog output (programmable 4-20mA) /K: 2DI/2DO /J: Alarm	1.KC 2.CJM
	AMC96-AI3	<ul style="list-style-type: none"> Three phase ammeter Display: LED Input: AC 1A or 5A 	/C: RS485(Modbus-RTU) /M: 1 analog output (programmable 4-20mA) /K: 2DI/2DO /J: Alarm	1.KC 2.CJM 3.3M+C
	AMC96L-AI3	<ul style="list-style-type: none"> Three phase ammeter Display: LCD Input: AC 1A or 5A 	/C: RS485(Modbus-RTU) /M: 1 analog output (programmable 4-20mA) /K: 2DI/2DO /J: Alarm	1.KC 2.CJM 3.3M+C
	AMC96-AV	<ul style="list-style-type: none"> Single phase voltmeter Display: LED Input: AC 100V, 220V or 380V 	/C: RS485(Modbus-RTU) /M: 1 analog output (programmable 4-20mA) /K: 2DI/2DO /J: Alarm	1.KC 2.CJM
	AMC96L-AV	<ul style="list-style-type: none"> Single phase voltmeter Display: LCD Input: AC 100V, 220V or 380V 	/C: RS485(Modbus-RTU) /M: 1 analog output (programmable 4-20mA) /K: 2DI/2DO /J: Alarm	1.KC 2.CJM
	AMC96-AV3	<ul style="list-style-type: none"> Three phase voltmeter Display: LED Input: AC 100V, 220V or 380V or 660V 	/C: RS485(Modbus-RTU) /M: 1 analog output (programmable 4-20mA) /K: 2DI/2DO /J: Alarm	1.KC 2.CJM 3.3M+C
	AMC96L-AV3	<ul style="list-style-type: none"> Three phase voltmeter Display: LCD Input: AC 100V, 220V or 380V 	/C: RS485(Modbus-RTU) /M: 1 analog output (programmable 4-20mA) /K: 2DI/2DO /J: Alarm	1.KC 2.CJM 3.3M+C

• Wiring

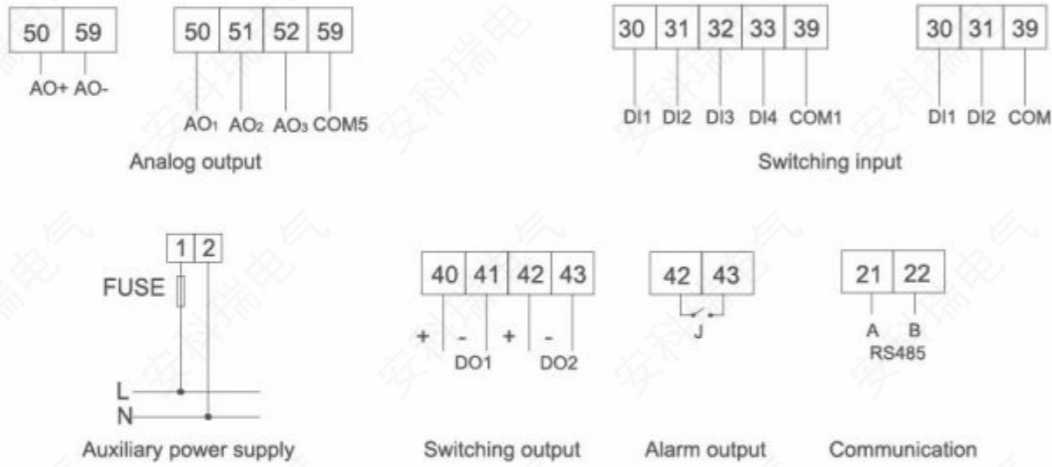

Single phase:

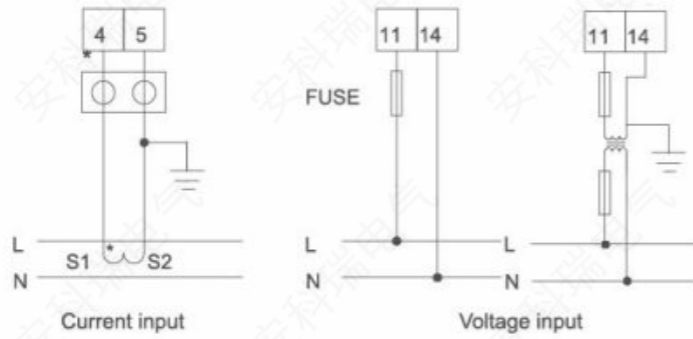

Three phase:

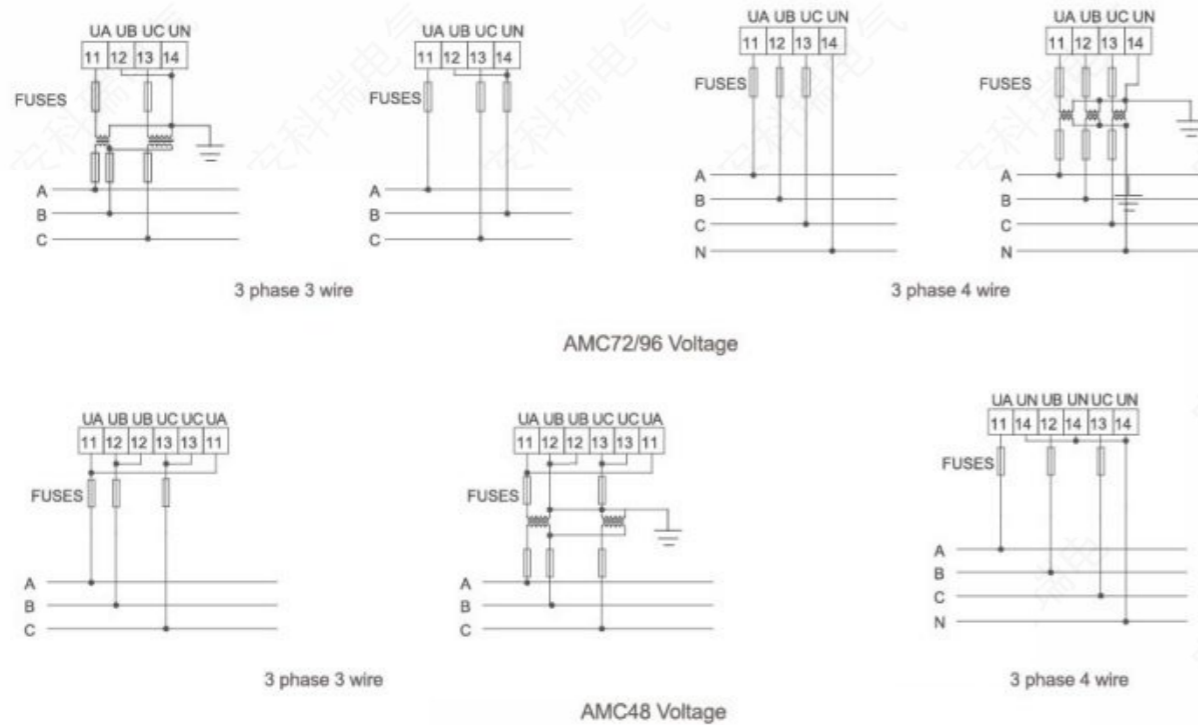

> 1.2 AC Multi-function Meter

• Model Description

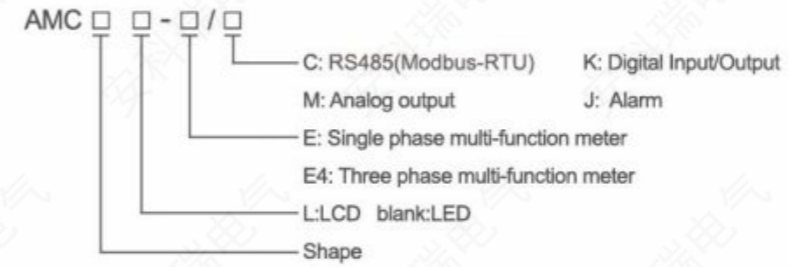



Shape	Panel size(mm)	Cut-out(mm)	Depth(mm)
72	75*75	67*67	94.3
96	96*96	92*92	77.8

• Technical Parameter

Technical parameter	Value	
Connection	3 phase 4 wire	
Frequency	45-65Hz	
Input	Voltage	Rating:AC 100V,400V Overload: 1.2 times rated value(continuous); 2 times rated value(1 second)
	Current	Rating: AC 1A,5A Overload: 1.2 times rated value(continuous); 10 times rated value (1 second)
	Power consumption	< 0.5VA
Output	Energy	Pulse width:80±20ms Pulse constant: 10000,40000,160000 imp/kWh
	Communication	RS485(Modbus-RTU)
Function	Switching input	2 channels or 4 channels passive contact input mode
	Switching output	Output mode:2 channel relay NO contact output Contact capacity: 3A/30V DC, 3A/250V AC
	Analog output	0-5V,0-20mA,4-20mA programmable
Accuracy	Frequency:0.05Hz,current,voltage:class 0.2, reactive power:class 1.0,reactive energy:class 1.0,other:class 0.5,2-31st harmonic :±1%	
Auxiliary power supply	AC/DC 85-265V	
Power consumption	≤10VA	
Insulation resistance	≥100MΩ	
Environment	Temperature	Operating: -10°C~+55°C Storage: -25°C ~+75°C
	Humidity	≤93%(no condensation)
	Altitude	≤2500m

Product Functions

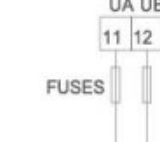
Shape	Type	Function	Option	Option Group
	AMC72-E	<ul style="list-style-type: none"> Single Phase Power meter Display: LED I, U, kW, kvar, kVA, kWh, kvarh, Hz, cosΦ 	/C: RS485(Modbus-RTU) /K: 2DI/2DO /J: alarm /KM: 2DI/2DO/1M	1.KC 2.CJ 3.KMC
	AMC72L-E	<ul style="list-style-type: none"> Single Phase Power meter Display: LCD I, U, kW, kvar, kVA, kWh, kvarh, Hz, cosΦ 	/C: RS485(Modbus-RTU) /K: 2DI/2DO /J: alarm /KM: 2DI/2DO/1M	1.KC 2.CJ 3.KMC
	AMC72-E4/KC	<ul style="list-style-type: none"> Three phase power meter Display: LED I, U, kW, kvar, kVA, kWh, kvarh, Hz, cosΦ 2DI2DO 1Ep pluse output 	/H: THDi, THDu, 2-31st harmonic /SOE: event record /K: 4DI/2DO /KM: 2DI/2DO/1M	1.H+SOE+K 2.H+SOE+KM
	AMC72L-E4/KC	<ul style="list-style-type: none"> Three phase power meter Display: LCD I, U, kW, kvar, kVA, kWh, kvarh, Hz, cosΦ 2DI2DO 1Ep pluse output 	/H: THDi, THDu, 2-31st harmonic /SOE: event record /K: 4DI/2DO /KM: 2DI/2DO/1M	1.H+SOE+K 2.H+SOE+KM
	AMC96-E4/KC	<ul style="list-style-type: none"> Three phase power meter Display: LED I, U, kW, kvar, kVA, kWh, kvarh, Hz, cosΦ 4DI2DO 1Ep pluse output 	/H: THDi, THDu, 2-31st harmonic /SOE: event record /2M: 2 analog output (When 2M is selected, the switching function is 2DI/2DO)	H+SOE+2M
	AMC96L-E4/KC	<ul style="list-style-type: none"> Three phase power meter Display: LCD I, U, kW, kvar, kVA, kWh, kvarh, Hz, cosΦ 4DI2DO 1Ep pluse output 	/H: THDi, THDu, 2-31st harmonic /SOE: event record /2M: 2 analog output (When 2M is selected, the switching function is 2DI/2DO)	H+SOE+2M

Wiring

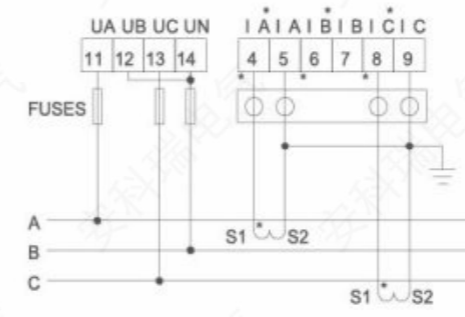
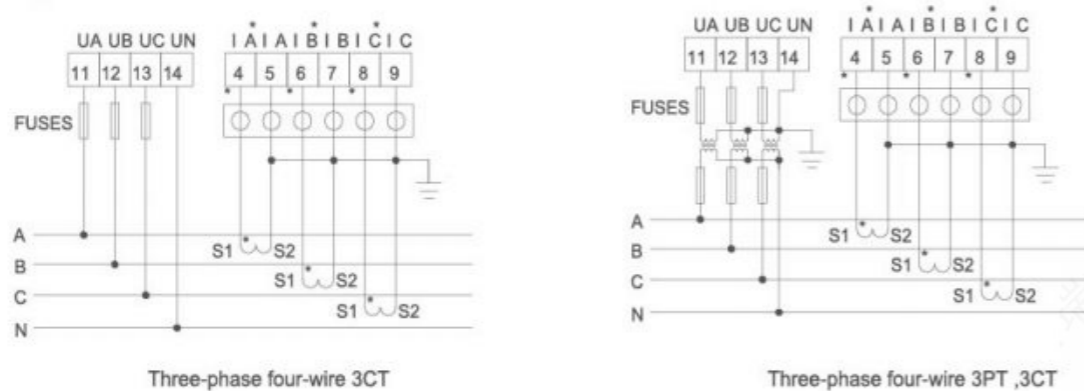

Three-phase three-wire 2CT

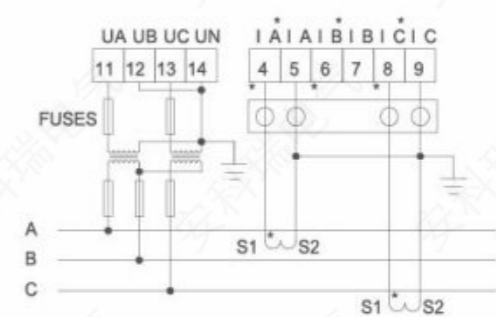

Three-phase three-wire 2PT, 2CT

1.3 DC Ammeter&Voltmeter

Model Description

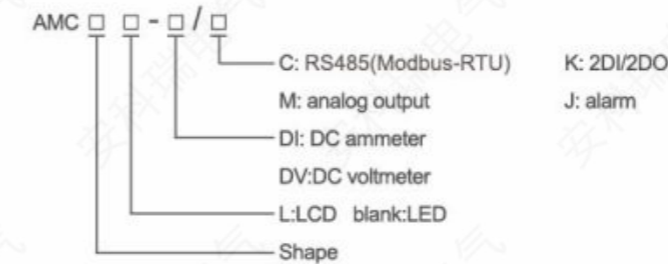

Shape	Panel size(mm)	Cut-out(mm)	Depth(mm)
72	75*75	67*67	94.3

Technical Parameter

Technical Parameter		Value			
Input	Rated value	Voltage: DC 1000V, 300V, 10V, 75mV; Current: DC 0-20mA, 4-20mA, 5A			
	Overload	Voltage: 1.2 times rated value(continuous); 2 times rated value (1 second) Current: 1.2 times rated value(continuous); 10 times rated value (1 second)			
	Frequency	45Hz~65Hz			
	Power consumption	Power consumption of each voltage, current input circuit is less than 0.5VA			
Accuracy		Class 0.5			
Function	Display	LED or LCD			
	Communication	RS485(Modbus-RTU)			
	Alarm	1 channel passive relay, contact capacity 3A/30VDC, 3A/250VAC			
	Analog output	DC4~20mA(load < 500Ω)			
	Switching	<table border="1"> <tr> <td>Input</td> <td>2 channels passive contact</td> </tr> <tr> <td>Output</td> <td>2 channels switching output, NO relay contact, capacity: 3A/30VDC, 3A/250VAC</td> </tr> </table>	Input	2 channels passive contact	Output
Input	2 channels passive contact				
Output	2 channels switching output, NO relay contact, capacity: 3A/30VDC, 3A/250VAC				

Technical Parameter		Value
Auxiliary power supply	Voltage range	AC/DC 85~265V
	Power consumption	<5VA
Insulation resistance		≥100MΩ
Environment	Temperature	Operating: -10°C~+55°C Storage: -25°C ~+70°C
	Humidity	≤93%(no condensation)
	Altitude	≤2500m

• Product Functions

Shape	Type	Function	Option	Option Group
	AMC72-DI	LED display DC programmable ammeter	/C: RS485(Modbus-RTU) /M: 1 analog output(programmable 4-20mA) /K: 2DI/2DO /J : Alarm	1. KC 2. CJM
	AMC72L-DI	LCD display DC programmable ammeter		
	AMC72-DV	LED display DC programmable voltmeter		
	AMC72L-DV	LCD display DC programmable voltmeter		

• Wiring

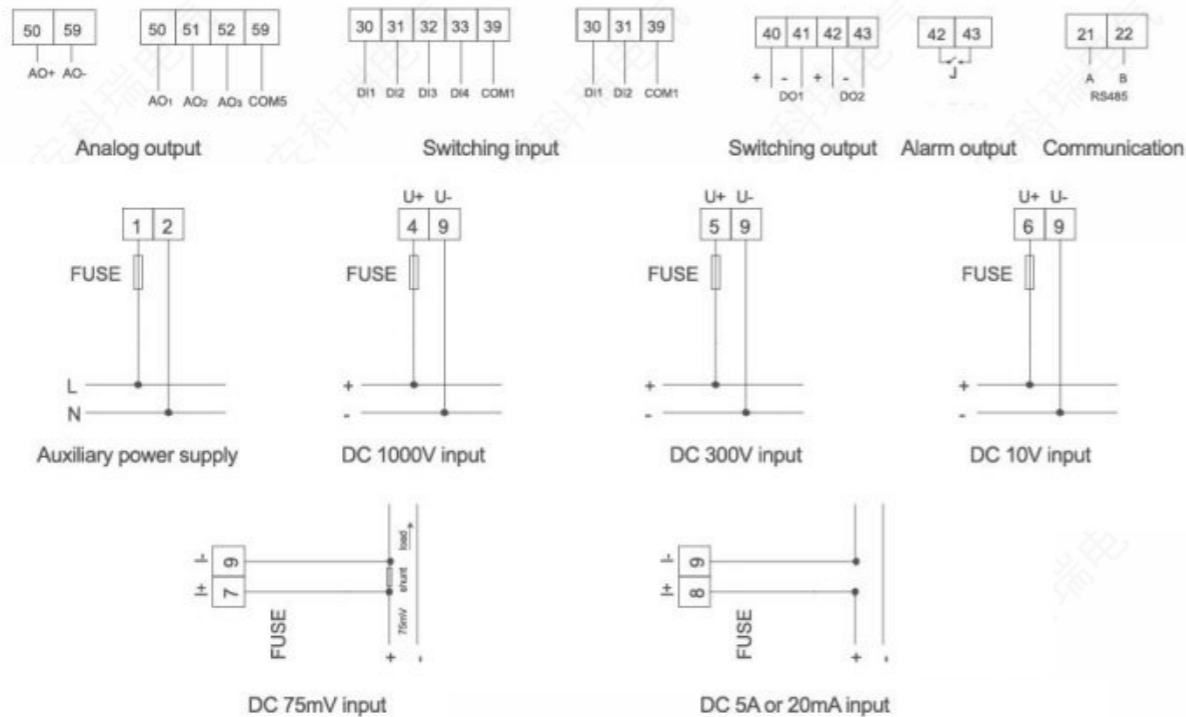

» 2.PZ Series DC Power Analyzer

• Model Description



- Optional function:
- C-RS485
 - V±12V power output
 - KC-RS485+2DI2DO(for 72 shape)
 - KC-RS485+4DI2DO(for 96 shape)
 - VC-RS485±12V power output
 - KVC-RS485+2DO±12V power output

The above functions can have the following two optional functions at the same time:

- F-Multiple rate
- ZD-Auxiliary power 20~60V

DC energy meter

Display method
L-LCD display
Blank-LED display

Shape
72-72 square
96-96 square



Shape	panel		shell			aperture	
	Wide	High	Wide	High	Deep	Wide	High
72 square	75±0.2	75±0.2	66±0.2	66±0.2	98±2	67±0.5	67±0.5
96 square	96±0.2	96±0.2	86±0.2	86±0.2	92±1	88±0.2	88±0.2

• Technical Parameter

Technical parameter		Indicators	
Input	DC voltage	Input range	Direct access: 0~100V, 0~500V, 0~1000V
		Input resistance	≥6kΩ/V
	DC current	Input range	Indirect access: 0-2500A(External Shunt or Hall Current Sensor, the range can be set)
		Shunt	75mV
		Hall sensor	0~20mA, 0~5V
Power consumption	≤1mW		
Overload	It can work at normal status at 1.2 times of full load, and can continued work 1 second at 2 times of full load.		
Accuracy class	0.5class		
Pulse constant	Voltage and current specifications: 750V、300A, Default pulse constant: 100imp/kWh		
	Voltage and current specifications: 1000V、300A, Default pulse constant: 100imp/kWh		
	Voltage and current specifications: 1000V、200A, Default pulse constant: 100imp/kWh		

Technical parameter		Value
Function	Measuring	Voltage- Current- Power
	Calculate	Current total electricity- Current positive energy- Current reverse power
	Multiple rate	Four time zones- two time table- fourteen time points- four multiple rates. (PZ72L-DE support only)
	Historical data statistics	Last 12 months of historical electricity(multiple rate electricity).(PZ72L-DE support only)
	DI- DO	PZ72 has two digital outputs and two digital inputs, PZ96 has two digital outputs and four digital inputs. DI(Collect and display local switch status information- Realize remote transmission by RS485)- DO(Relay output, can achieve "remote control" and alarm output)
	Display	LCD(the backlight delay time can be adjusted) or LED
	Communication	RS485- Half duplex- Photoelectric isolation- Modbus-RTU / DL/T645-07- Band:1200/2400/4800/9600- Infrared: 1200
Working power	DI- DO	DI Dry contact input, Meter built-in power supply, photoelectric isolation DO Two relay outputs, Normally open contact, capacity:2A/30VDC or 2A/250VAC
	Voltage range	85~265VAC/DC- 50/60Hz; 20~60VDC;100~350VDC(Indicate when placing an order)
	Power consumption	≤2W
	Insulation resistance	≥100MΩ
	Power frequency	3kV/1min (RMS) (between the power supply binding post and the signal binding post)
Environment	Temperature	Working temperature: -10℃~+55℃; storage temperature: -20℃~+70℃
	Humidity	≤95%RH, No condensation, no corrosive gases
	Altitude	≤2000m

Product Functions

Shape	Type	Display	Shape	Basic Function	Optional Function
	PZ72L-DE	LCD display	72 Square	DC: voltage, current, power, energy	1. RS485 (/C) 2. 12V power output①(/V) 3. RS485 + 2DO (/KC) RS485 + 2DI2DO(/KC) RS485 + 4DI2DO②(/KC) 6. RS485 + 2DO + 12V power output (/KVC) 7. RS485 + 12V power output (VC) 8. RS485 + 0.001kWh(/EC) The above functions can have the following two optional functions at the same time: 9. Auxiliary power 20-60V (/ZD) 10. Multiple rate(F)
	PZ72-DE	LED display			
	PZ96L-DE	LCD display	96 Square		
	PZ96-DE	LED display			

Note: ①The function of 12V power output and DI can't be selected at the same time;

②Only PZ96 (L) -DE has 4DI2DO function.

Wiring

Auxiliary power supply

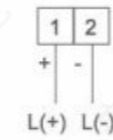

Signal input

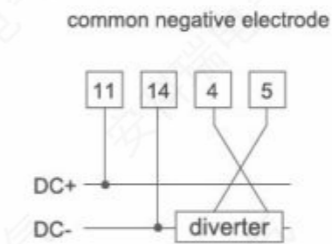

Additional function

PZ72(L)-DE

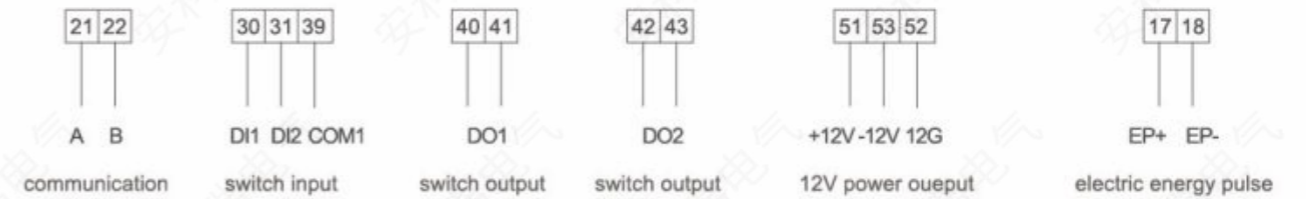

PZ96(L)-DE

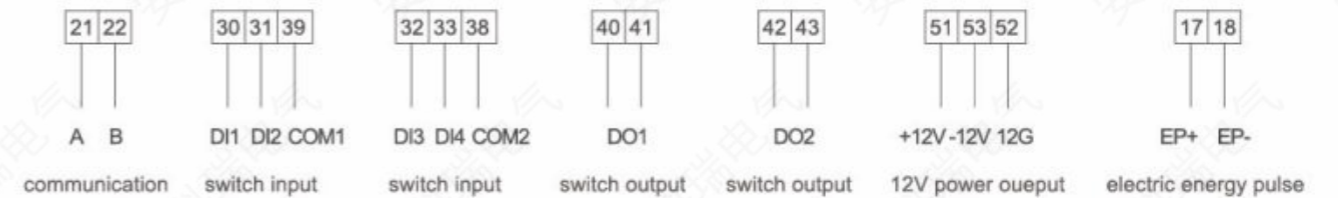

3.ARTU Series Unit

3.1 ARTU Series Remote Terminal Unit

Model Description

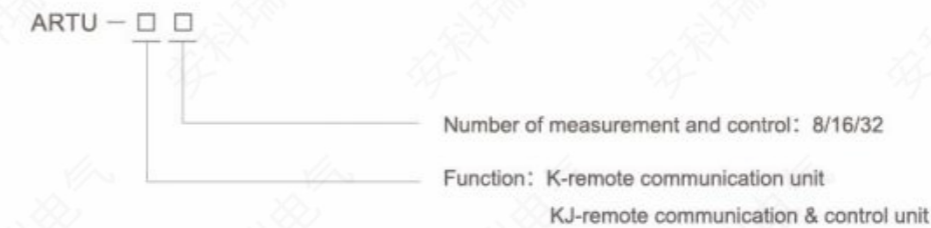

Technical Parameter

ARTU-KJ8

Technical parameter	Switch input	Relay output
Input/Output circuit	8	8
Input/Output mode	Passive contact	8 channel relay output(pulse or hold mode)
Communication	RS485(Modbus-RTU)	RS485(Modbus-RTU)
Bus capacity	≤32	≤32

Technical parameter	Switch input	Relay output
Resolution (SOE)	The successive of time interval between two contacts > 1ms	/
Scan time	1ms	/
Filter time	1ms	/

◆ ARTU-K8/16/32

Technical parameter	Specifications
Input circuit	8/16/32
Input	Active contact(DC12V) or passive contact
Communication	RS485(Modbus-RTU)
Bus capacity	≤32
Resolution (SOE)	Distinguishing capability for bit changing in succession of multiple contacts. When the bit changing interval of any two contacts is more than 1ms, the distinguishing capability(less than 2ms) of the unit is reflected in SOE.
Scan time	1ms
Filter time	1ms
SOE capacity	1600sets

• Product Functions

◆ ARTU-KJ8

Technical parameter	Function description
Auxiliary power supply	24VDC (±10%) 220VAC,allow AC/DC 85-265V
Power consumption	≤5W
Frequency	≤500HZ
Relative humidity	≤95%(No condensation)
Operating temperature	-5°C~+55°C
Storage temperature	-25°C~+70°C
Altitude	≤2500m

◆ ARTU-K8/16/32

Technical parameter	Function description
Auxiliary power supply	24VDC (±10%) 220VAC,allow AC85~275V/DC100~350V
Power consumption	≤5W
Frequency	≤500HZ
Relative humidity	≤95%(No condensation)
Operating temperature	-5°C~+55°C
Storage temperature	-25°C~+70°C
Altitude	≤2500m

• Wiring

◆ ARTU-KJ8

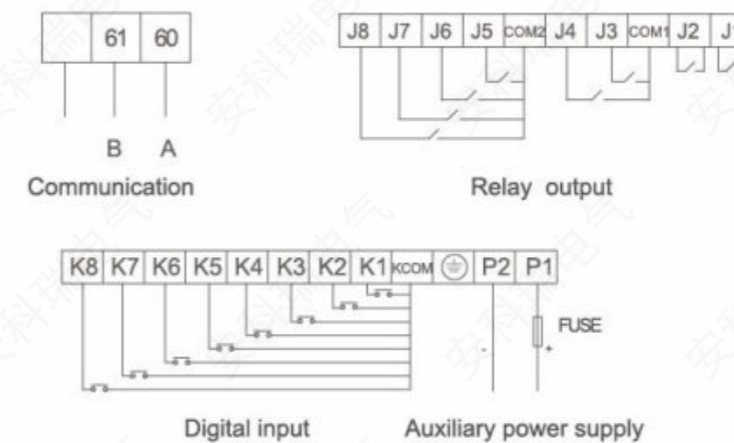

◆ ARTU-K8/16

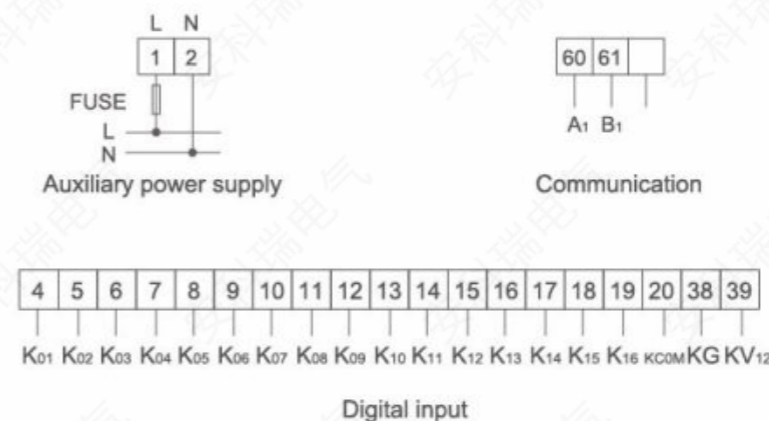

◆ ARTU-K32

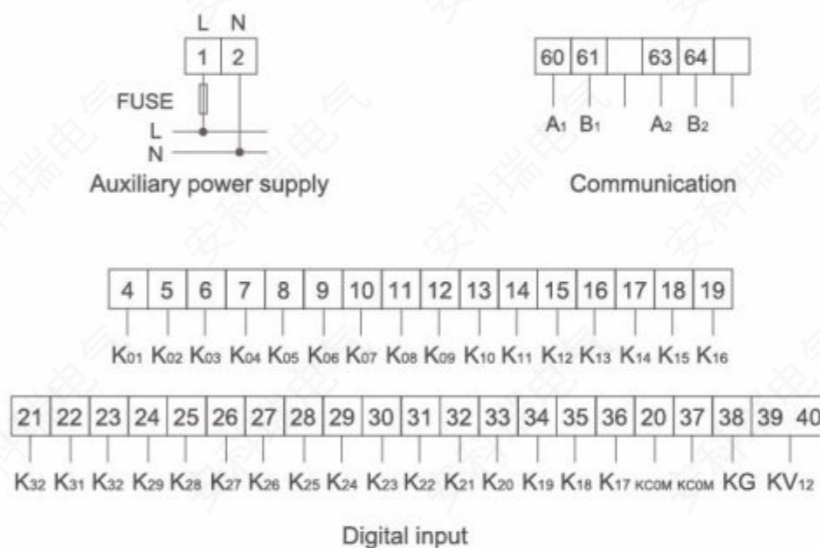

> 3.2 ARTU100 Series Modular Remote Terminal Unit

• Model Description

ARTU100 - □ / □

Additional code:
 CE-1 channel Ethernet
 MKA18-18 channels DI (active AC220V)
 MK18-18 channels DI (passive)
 MJ16-16channels DO
 MA84-8 channels AI, 4-channels AO
 Mpow

Function code:
 KJ8-8 channels DI, 8-channels DO
 KJ16-16 channels DI
 K32-32 channels DI

Product model



• Technical Parameter

Security	Working withstand voltage	Power-frequency with stand voltage: Shell and power supply, switch input, switch output, analog input, analog output, communication, AC2kV1min; AC2kV1min between power supply and switch output; AC 1kV 1min between analog input and analog output and between communication and switch input;
	Insulation resistance	Input and output end to housing > 100MΩ;
Electromagnetic compatibility		Level 3
Environment	Working temperature:	-10℃~+55℃;
	Storage temperature:	-40℃~+70℃;
	Relative humidity :	≤95% without condensation;
	Altitude:	≤2000m;

• Product Functions

◆ Subject:

Power supply		AC/DC 85-265V or DC48V
Power consumption		≤9W (excluding modules); ≤15W (including modules, up to 3 modules)
Model	ARTU100-K32	32-channel DI (active/passive, optional)
	ARTU100-K16	16-channel DI (active/passive, optional)
	ARTU100-KJ8	8-channel DI (active/passive, optional); 8-channel DO, output mode: relay normally-open contact output, contact capacity: AC 250V/3A DC 30V/3A;

Communication	485 communication	RS485 interface	2-channel 485 communication; Modbus-RTU protocol; baud-rate 1200 ~ 38400bps
Others	Dial switch		10 bits
	Indicator light		20 indicator lights

◆ Optional features:

Model	CE	1 path ethernet	TCP/IP protocol; 10M/100M self-adaptive
	MKA18	Switch input	18-channel DI (active AC 220V)
	MK18	Switch input	18-channel DI (passive)
	MJ16	Switch output	16-channel DO output mode: Relay normally-open contact output
	MA84	Analog input	8-channel AI; 0-5V, 1-5V, 4-20mA, 0-20mA, optional
		Analog output	4-channel AO; 0-5V, 1-5V, 4-20mA, 0-20mA, optional
	AWT100-2G	2Gcommunication terminal	
	AWT100-Lora	Loracommunication terminal	
	AWT100-LW	LoRAWANcommunication terminal	
AWT100-4G	4Gcommunication terminal		

Remark: When expanding the module, an optional power module is also required

• Wiring

◆ Subject:

ARTU100-K32:

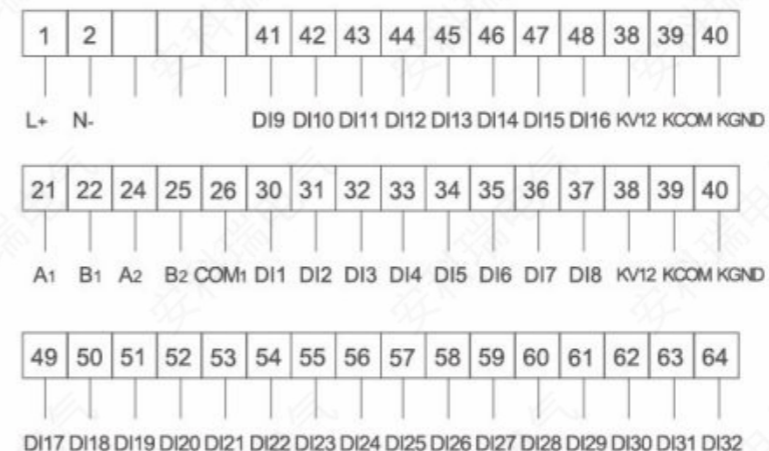

ARTU100-K16:

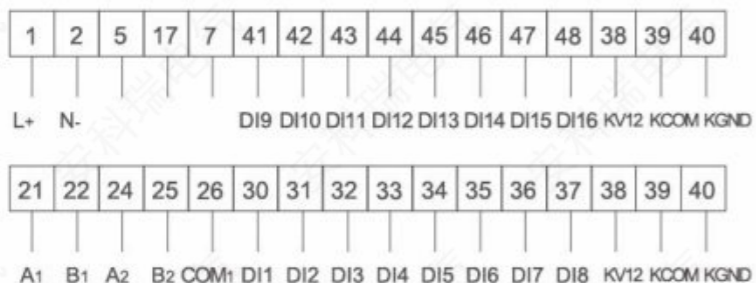

ARTU100-KJ8:

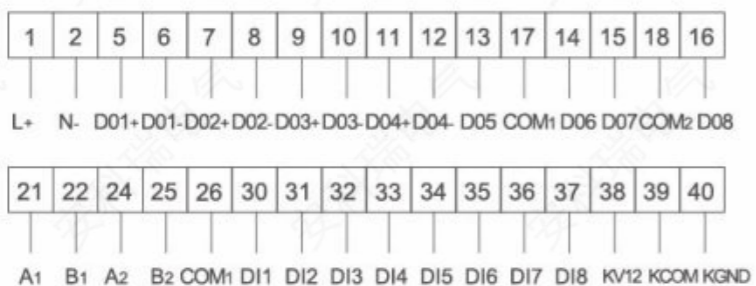

◆ Modules:

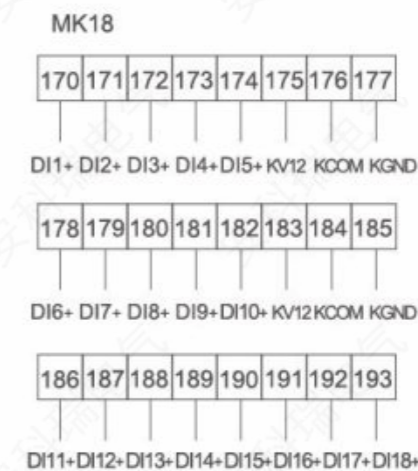
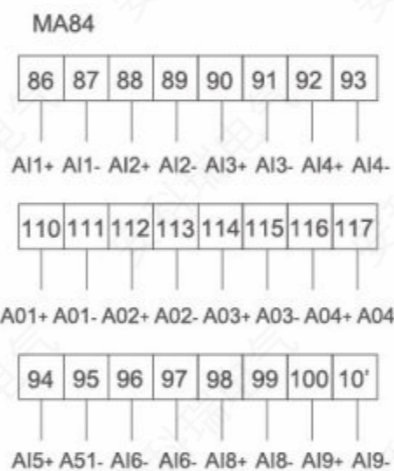
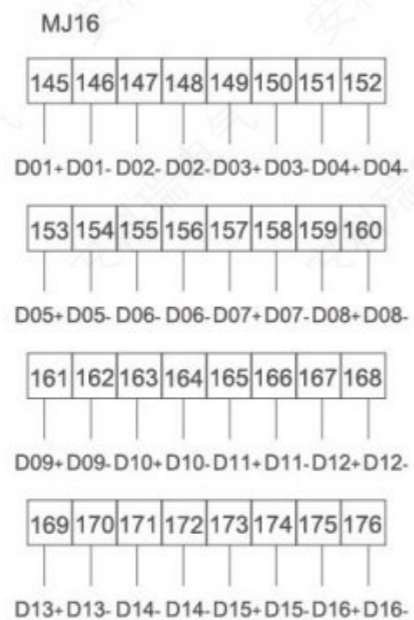
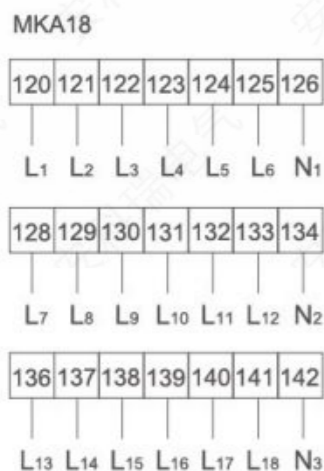

4.ARD Series Smart Motor Protector

4.1 ARD2 Smart Motor Protector

• Model Description



Table 1 Additional function

Additional features	Code	Additional features	Code
RS485(Modbus-RTU)	C	2 switch input; 1 relay output (programmable 3)	K
Leakage Protection	L	SOE record	SR
4~20mA analog output	M	Alarm (programmable 2)	J

Table 2 Rated current

Rated current (A)	Ratio setting	Transformer primary side turns	Setting current range (A)	Motor power (kW)
1	Need	5	0.1~999.9	0.12~440
5		1	0.1~999.9	0.12~440
1.6	No need	1	0.4~1.6	0.12~0.55
6.3		1	1.6~6.3	0.75~2.2
25		1	6.3~25	3~11
100		1	25~100	15~45
250		1	63~250	55~132
800		1	250~800	160~440

Note: When the additional function is equipped with leakage protection 'L', it is necessary to purchase leakage current transformer with different apertures according to the actual current.

Table 3 Leakage current protection(L) list

Rated current(A)	CT type	CT aperture
≤100A	KB1:5A/5mA	φ 46mm
100A-250A	KB2: 5A/5mA	φ 81mm
250A-800A	KB3: 5A/5mA	φ 150mm

• Technical Parameter

Technical parameter	Value	
Auxiliary power supply	AC85~265V/DC100~350V,power consumption 15VA	
Rated voltage	AC380V/AC660V,50Hz/60Hz	
Rated current	1A(0.1A-999.9A)	
	5A(0.1A-999.9A)	
	1.6A(0.4A-1.6A)	
	6.3A(1.6A-6.3A)	
	25A (6.3A-25A)	
	100A (25A-100A)	
	250A (63A-250A)	
	800A (250A-800A)	
Relay output contactor, rated negative capacity	4 channels,AC 250V,3A	
Switching input	2 channels,opto-coupler isolation	
Communication	RS485(Modbus-RTU)	
Environment	Operation Temperature	-10℃~55℃
	Storage temperature	-20℃~60℃
	Relative humidity	5%~95% (No condensation)
	Altitude	≤2000m
Class of pollution	Level 2	
Protection level	Main module IP 20	
Installation category	Class III	

• Product Functions

Functions	Model	ARD2	ARD2L
Application	Low voltage 0.4kV-1.14kV motor protection		
Protection	Timeout starting	■	■
	Overload	■	■
	Underload	■	■
	Short circuit	■	■
	Blocking	■	■

Functions	Model	ARD2	ARD2L
Protection	Lock	■	■
	Unbalance	■	■
	External fault	□	□
	Phase failure	■	■
	Alarm	□	□
	Residual current (choose one)	Earthing	■
	Leakage	□	□
Communication	RS485(Modbus-RTU)	□	□
Switch input	2	□	□
Relay output	4	2-way standard 2-way optional	
	4-20mA analog output	□	□
Record	8 records	□	□
Parameter measurement	Three-phase current	■	■
	Leakage current	□	□
	Frequency	■	■
Display	LED	■	
	LCD		■

Note: ■standard □optional

• Wiring

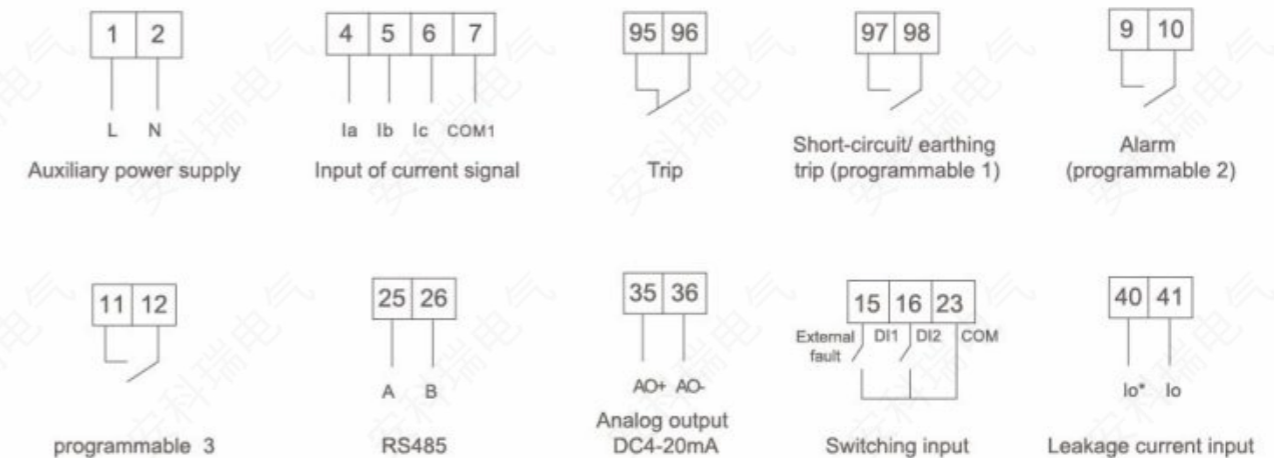

> 4.2 ARD2F Smart Motor Protector

• Model Description

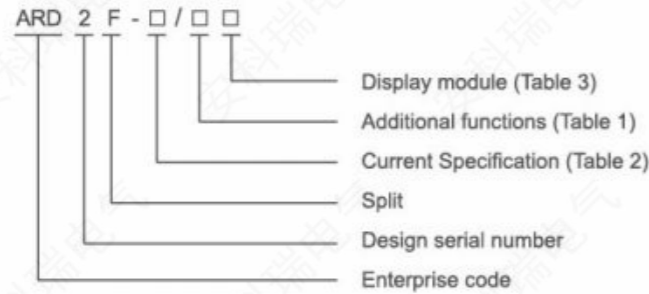

Additional functions of ARD2F are shown in Table 1:

Table 1 Additional functions

Additional function	Code	Additional features	Code
Starting control (including K function)	Q	Leakage protection	L
Switching input	K	4-20mA analog output	M
Temperature protection	T	Anti - electric shock function	SU
Alarm (Programmable output)	J	SOE event record	SR
1 channel communication	Modbus_RTU	2 channel communication	2 Modbus_RTU
	Profibus_DP		Modbus+Profibus
Voltage function (phase sequence, power, power factor)	U	tE time protection	tE
Energy metering	Ep		

The corresponding relation between ARD2F current specification and the rated current and power of the applicable motor is shown in Table 2:

Table 2 rated current

Protector current specification (A)	Ratio setting	Primary side coil number of transformer	Applicable scope of motor (kW)	Suitable for motor Rated current range (A)
1	Support	5circle	0.12-999	0.1-5000
5		1circle	0.12-999	0.5-5000
1.6	Does not support	1circle	0.12-0.55	0.4-1.6
6.3		1circle	0.75-2.2	1.6-6.3
25		1circle	3-11	6.3-25
100		1circle	15-45	25-100
250		1circle	55-132	63-250
800		1circle	160-250	250-800

See Table 3 for the ARD2F display module:

Table 3

Display module	code
90L	LCD display, module size 98×60, opening 92×55 (unit:mm)

• Technical parameter

Technical parameter	Technical indicators	
Protector auxiliary power supply	AC85-265V/DC100-350V	
Rated working voltage of the motor	AC220V / 380V / 660V , 50Hz / 60Hz	
Rated operating current of the motor	1 (0.1A-5000A)	External current transformer
	5 (0.1A-5000A)	
	1.6A(0.4A-1.6A)	
	6.3A (1.6A-6.3A)	
	25 (6.3A-25A)	
	100 (25A-100A)	
	250 (63A-250A)	
800 (250A-800A)		
Relay output contact capacity	Impedance load	AC250V- 10A
Switching input	9 channels of passive dry contact (active DC110V, DC220V, AC220V input can be optional)	
Communication	RS485 Modbus_RTU, Profibus_DP	
Environment	Working temperature	-10°C~55°C
	Storage temperature	-25°C~70°C
	Relative humidity	≤95% No condensation, no corrosive gas
	Altitude	≤2000m
Pollution levels	Class 3	
Protection grade	Main body IP20, split display module IP54 (installed on the cabinet panel)	
Installation category	Level III	

• Product Functions

The ARD2F functional configuration is shown in Table 5

Functions	Model	ARD2F		
		Standard function	Optional function	
Protection function	Fixed time overload	√		
	Inverse time overload	√		
	Starting timeout	√		
	Phase loss	√		
	Voltage unbalance	√		
	Current unbalance	√		
	Locked-Rotor	√		
	underload	√		
	External fault	√		
	Block	√		
	Temperature protection (PTC/NTC)	√		
	Residual current	grounding	√	
		leakage		√ (leakage)

Functions	Model	ARD2F	
		Standard function	Optional function
Protection function	Phase sequence	√	
	Under voltage	√	
	Overvoltage	√	
	Underpower	√	
	Overpower	√	
	tE Time protect	√	
	Overflow protection	√	
	Alarm of starting times	√	
	Running time alarm	√	
	Fault frequency alarm	√	
Control mode	Protection mode	√	
	Direct start mode		√
	Two-step mode		√
	Two-speed mode		√
	Y-Δ start mode		√
Communication	Voltage loss restart		√
	1 channel Modbus-RTU communication		√
	2 channel Modbus-RTU communication		√
	1 channel Profibus-DP communication		√
Switching input	1 channel Modbus-RTU+1 channel Profibus-DP		√
	9 channel DI(programmable)		√
Relay output	2 channel DO(programmable)	√	
	5 channel DO(programmable)		√
Analog output	1 channel DC4-20mA		√
Event record	Start record, stop record, DI displacement record, restart record, (support communication transmission and U disk export)		√
Panel	Liquid crystal display (LCD)		
	Black and white dot matrix LCD display		√

• Wiring

The wiring terminal arrangement of the ARD2F main body is shown in Figure 9:

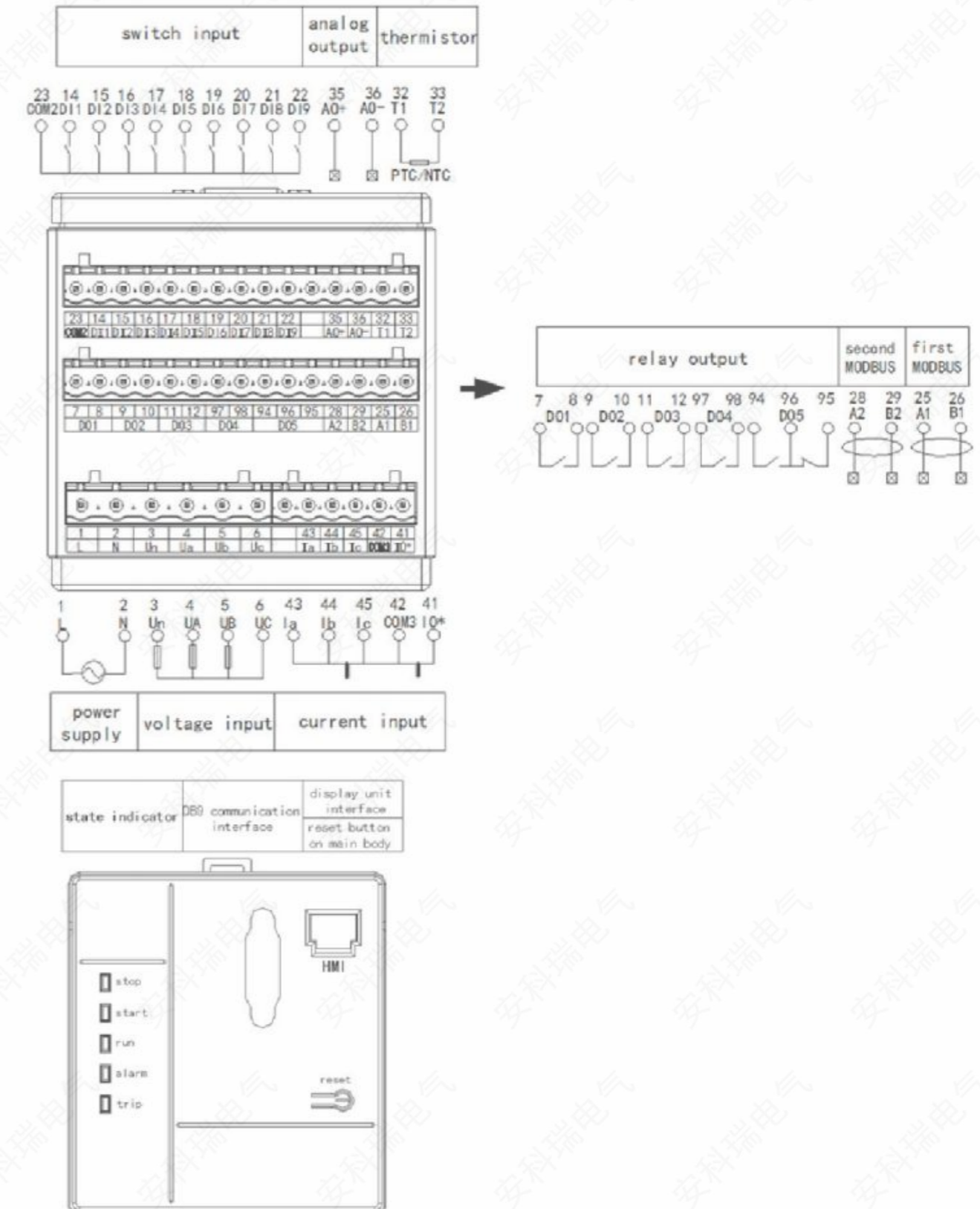

Fig. 9 ARD2F terminal arrangement

> 4.3 ARD3M Intelligent Motor Protector

• Model Description



The standard switch quantity of ARD3M is 10DI and 6DO, and the switch quantity type is shown in Table 1:

Table 1

Main switch classification	Code
DI is the dry contact, and the external power supply of DO is AC220V	K1
DI is the wet contact, the input is DC110V, and the external power supply of DO is AC220V	K2
DI is the wet contact, the input is DC220V, and the external power supply of DO is AC220V	K3
DI is the wet contact, AC220V input, and DO external power supply is AC220V	K4

Table 2 Additional function

Additional function	Code	Additional features	Code
2-63 harmonic voltages and currents	H	Waveform recording	WR
Additional Communication module (Optional)	1channel PROFIBUS DPV1communication	Anti - electric shock function	SU
	2 channel PROFIBUS DPV1communication	Insulation monitoring	Ri
	Ethernet communication (MODBUS TCP protocol)	Electric leakage protection	L
	1channel Profinet communication	Fault record	SR
1channel 4-20mA output	M1	2 channel 4-20mA output	M2

Table 3 Rated current

Protector current specification (A)	Ratio setting	Primary side coil number of transformer	Applicable scope of motor (kW)	Suitable for motor Rated current range (A)
1	Support	5 circle	0.12-999	0.1-5000
5		1circle	0.12-999	0.5-5000
25	Does not support	1circle	3-11	6.3-25
100		1circle	15-45	25-100
250		1circle	55-132	63-250
800		1circle	160-250	250-800

Table 4 Display module

Display module	code
Black and white dot matrix LCD, module size 98×60, opening 92×55 (unit mm)	60L1
Color dot matrix LCD, module size 98×60, cut-out 92×55 (Unit mm)	60L2

• Technical parameter

Technical parameter	Technical indicators	
Protector auxiliary power supply	Support two power modules, AC 220V power module (AC85-265V/DC100-300V) default, AC 380V power module (AC/DC 100-415V) optional	
Rated working voltage of the motor	AC220V / 380V / 660V , 50Hz / 60Hz	
Rated operating current of the motor	1 (0.1A-5000A)	External current transformer
	5 (0.1A-5000A)	
	25 (6.3A-25A)	
	100 (25A-100A)	
	250 (63A-250A)	
Relay output contact capacity	Impedance load	AC250V· 10A
	800 (250A-800A)	
Switching input	10 channels of passive dry contact (active DC110V, DC220V, AC220V input can be optional)	
Communication	Optional (only one can be selected)	1-2 channel PROFIBUS DPV1communication、1channel PROFINET communication、Ethernet communication (MODBUS TCP protocol)
Environment	Working temperature	-10°C~55°C
	Storage temperature	-25°C~70°C
	Relative humidity	≤95% No condensation, no corrosive gas
	Altitude	≤2000m
Pollution levels	Class 3	
Protection grade	Main body IP20, split display module IP54 (installed on the cabinet panel)	
Installation category	Level III	

• Product Functions

Functions	Type	Functional Functions	
		Standard function	
Protection function	Fixed time overload	√	
	Inverse time overload	√	
	Starting timeout	√	
	Phase loss	√	
	Voltage unbalance	√	
	Current unbalance	√	
	Locked-rotor	√	
	under load	√	
	External fault	√	

Functions	Type	Functional Functions		
		Standard function	Optional function	
Protection function	Block	√		
	Temperature protection (PTC/NTC)	√		
	Residual current	grounding	√	
		leakage		√ (leakage)
	Phase sequence	√		
	Under voltage	√		
	Overvoltage	√		
	Underpower	√		
	Overpower	√		
	tE Time protect	√		
	Overflow protection	√		
	Alarm of starting times	√		
	Running time alarm	√		
	Fault frequency alarm	√		
Control mode	Protect type	√		
	Manual mode	√		
	Two step model	√		
	Double speed mode	√		
	Star triangle three successive	√		
Communication function	PowerShake and start again	√		
	2channel Modbus-RTU communication	√		
	1-2channel PROFIBUS DPV1 communication		√	
	1channel PROFINET communication		√	
Analog output	1channel Ethernet communication (dual network port)		√	
	WIFI function		√(Optional with color dot matrix LIQUID crystal)	
Switching input	10DI	√		
Relay output	6DO	√		
Analog output	1channel DC4-20mA		√	
	2channe DC4-20mA			
Event log	Start record,stop record,DI displacement record,restart record,operation record (support communication transmission and U disk export)		√	
Waveform recording	Record the current,voltage,DI/DO waveform before and after the fault trip,support communication transmission and U disk export		√	

Functions	Type	Functional Functions	
		Standard function	Optional function
Measurement display constant value setting	Measured parameters	Three phase current,three phase line voltage,active power,reactive power,powerfactor,frequency,active power,reactive power,etc	√
		2-63rd current,voltage harmonics,harmonicinclusion rate,total harmonic distortion rate Various protected fixed value queries	√
	Fixed value setting	Various protection Settings	√
		Various protected fixed value queries	√
Panel	Liquid crystal display (LCD)	Black and white dot matrix LCD display	
		Color dot matrix LIQUID crystal display	√

• Wiring

The wiring terminal arrangement of the ARD3M main body is shown in Figure 13:

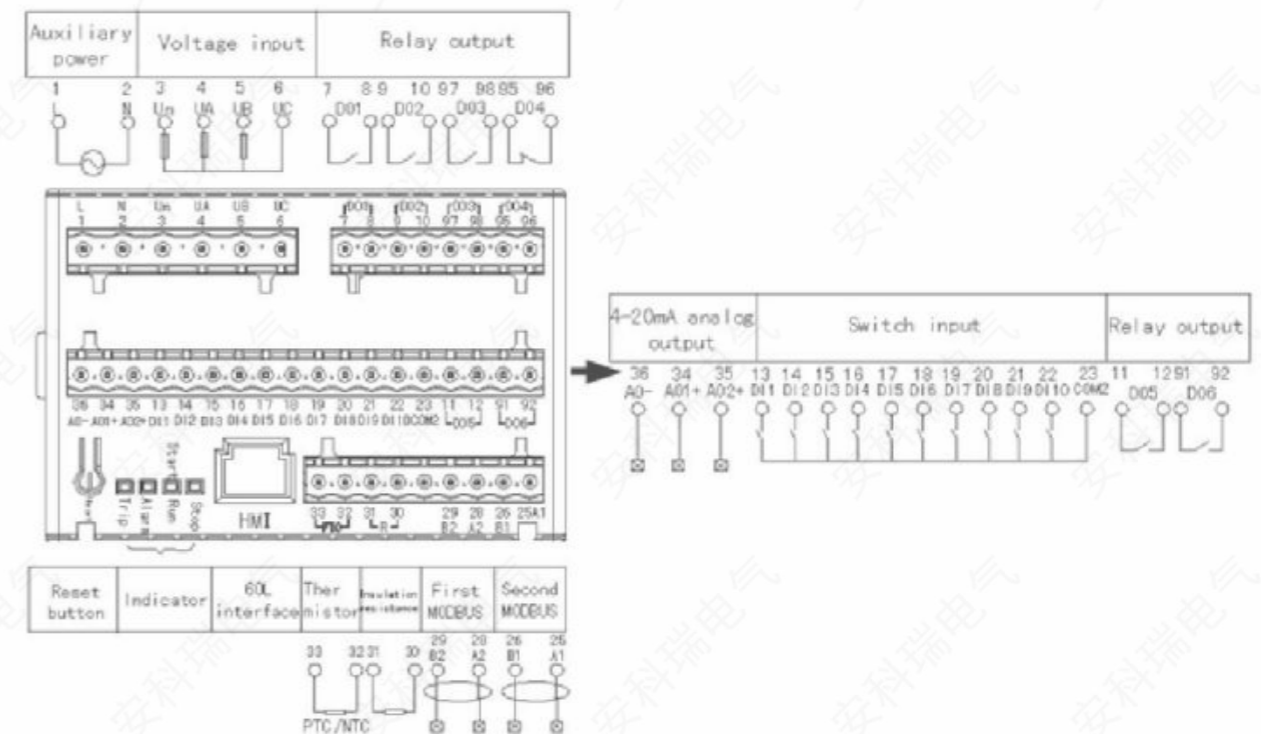

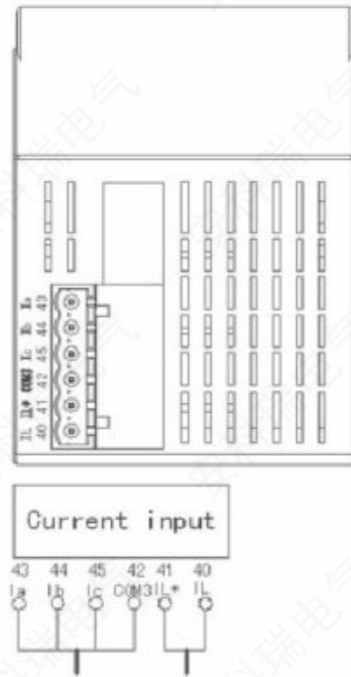
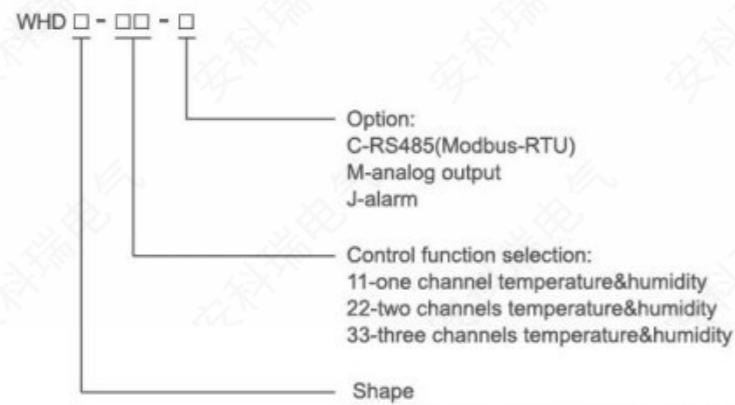

FIG. 13 ARD3M terminal arrangement

5.WHD Series Smart Temperature and Humidity Controller

Model Description



Shape	Panel size(mm)	Cut-out(mm)
48	48*48	45*45
72	75*75	67*67
46	120*60	116*56
20R	DIN 35mm	

Technical parameter

Technical Parameter		Value
Set range of controlling parameters	Heating for Temperature rising	-40℃~40℃
	Blowing for temperature decreasing	0℃~99.9℃
	Humidity control	20%RH~90%RH

Technical Parameter		Value
Contact capacity		5A/AC250V
Communication		RS485(Modbus-RTU)
Auxiliary power supply	Working range	AC 85~265V,DC 100~350V
	Consumption	Basic power consumption(≤0.8w)+ relay power consumption(each channel≤0.7w)
Insulation resistance		≥100MΩ
Environment	Temperature	-20℃~+60℃
	Humidity	≤95%RH (No condensation)
	Altitude	≤2000 m
Measuring range	Temperature	-40.0℃~99.9℃
	Humidity	0%RH~99%RH
Precision	Temperature	±1℃
	Humidity	±5%RH

Product Functions

Shape	Type	Function	Option	Option Group
	WHD48-11	Measure one channel temperature & humidity(with sensors)	/C: RS485(Modbus-RTU)	/
	WHD72-11	Measure one channel temperature & humidity(with sensors)	/C: RS485(Modbus-RTU)	1.JC 2.JM
	WHD72-22	Measure two channels temperature & humidity(with sensors)	/M: Two analog output (programmable 4~20mA)	
	WHD46-11	Measure one channel temperature & humidity(with sensors)	/C: RS485(Modbus-RTU)	/
	WHD46-22	Measure two channels temperature & humidity(with sensors)	/J: Alarm	
	WHD46-33	Measure three channels temperature & humidity(with sensors)	/M: Two analog output (programmable 4~20mA)	
	WHD20R-11	Measure one channel temperature & humidity(with sensors)	/C: RS485(Modbus-RTU)	JC
	WHD20R-22	Measure two channels temperature & humidity(with sensors)	/J: Alarm	
	WH-M	Measure one channel temperature & humidity,1RS485(Modbus-RTU)	/	/

• Accessory

◆ Temperature and humidity sensor

Type	Function
WH-3	one channel humidity +one channel temperature

◆ Heater

Name	Type
Aluminum alloy heater (Economic type)	ALW-75W
	ALW-150W
	ALW-250W

• Wiring

WHD48:

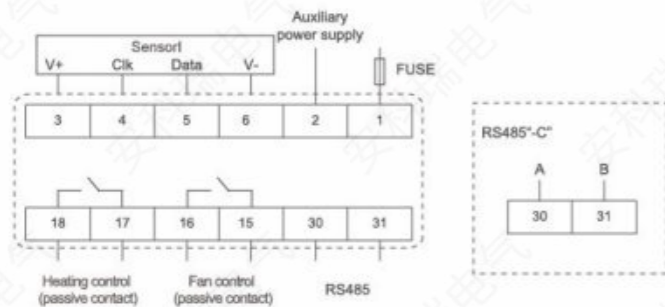

WHD72:

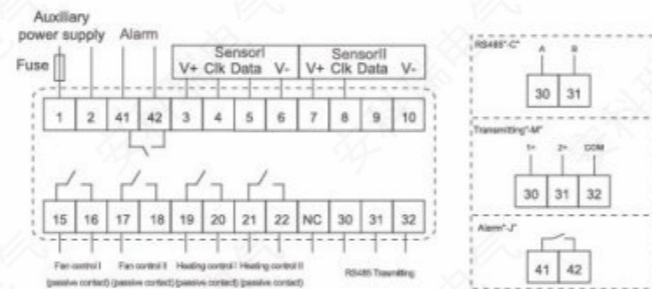

WHD46:

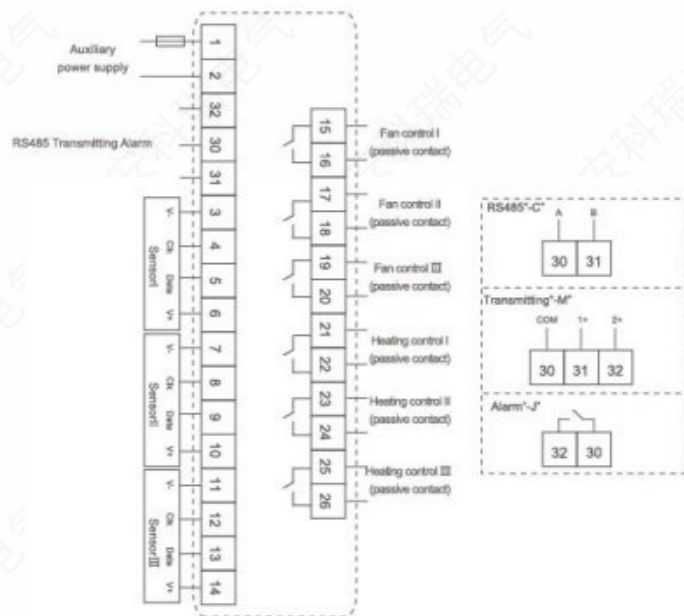

WHD20R:

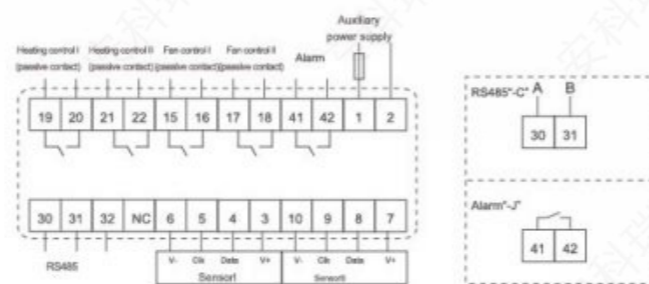

➤ 6.AM Series Protection Relay

➤ 6.1 AM5SE Series Protection Relay

• Model Description

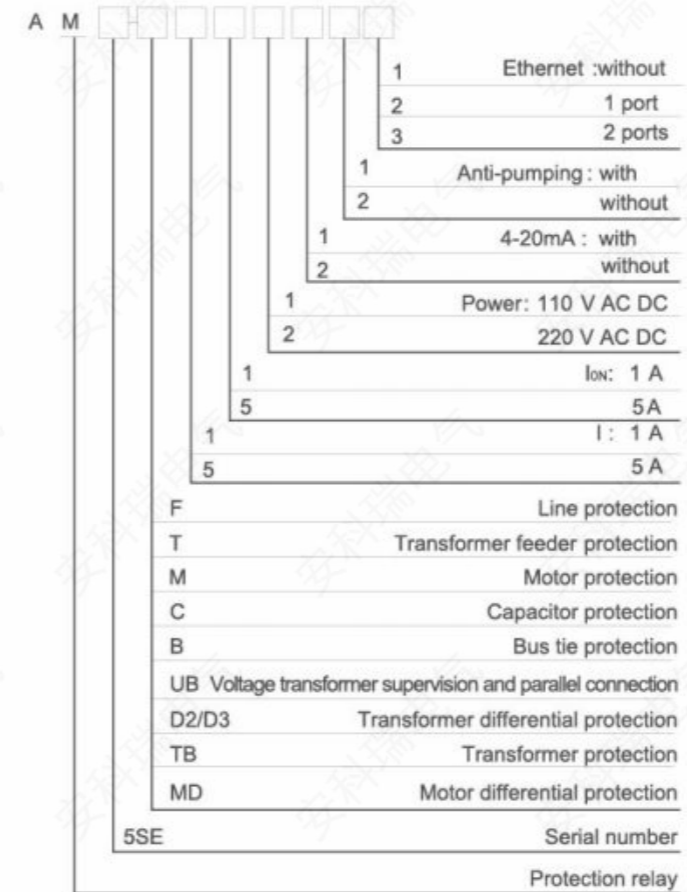

• Functions

Protection Functions	AM5SE-								
	F	D2/D3	TB	T	MD	M	B	C	UB
3 stages directional overcurrent (with voltage dependant)	■		■						
Differential protection with ratio restraining		■			■				
Instantaneous differential		■			■				
3 stages overcurrent (with composite voltage blocking)				■					
Motor start overcurrent (instantaneous)					■	■			
Motor run overcurrent (2-stages)					■	■			
2 stages directional overcurrent							■	■	
Overcurrent IDMT	■		■	■	■	■	■	■	
Bus charge							■		

Protection Functions	AM5SE-								
	F	D2/D3	TB	T	MD	M	B	C	UB
2 stages earth fault	■		■	■	■	■		■	
Earth fault IDMT	■		■	■					
Overload (alarm)	■		■	■	■	■			
Overload (trip)	■		■	■	■	■			
Trip and close circuit supervision (alarm)	■		■	■	■	■	■	■	
Undervoltage (trip)					■	■			
Undervoltage (alarm)									■
Loss of voltage (trip)	■								
Loss of voltage (alarm)	■								
Overvoltage (trip)					■	■		■	
Overvoltage (alarm)									■
Capacitor undervoltage (trip)								■	
Residual overvoltage (trip)	■		■		■			■	
Residual overvoltage (alarm)			■		■	■			■
Unbalance voltage					■			■	
Unbalance current					■			■	
PT supervision	■		■	■	■	■	■	■	■
PT supervision and parallel connection									■
CT supervision		■			■				
Three phase auto-reclose	■								
Under frequency	■								
Over frequency	■								
Post-accelerated overcurrent	■						■		
Directional power	■								
Non-electricity			■	■	■	■		■	
Blocking rotor					■	■			
Starting time-out					■	■			
Thermal overload					■	■			
Overvoltage average					■	■			
Incorrect phase sequence					■	■			

Protection Functions	AM5SE-								
	F	D2/D3	TB	T	MD	M	B	C	UB
Voltage phase loss					■	■			
Negative sequence overcurrent (2 stages/IDMT)					■	■			
Bus tie protection and standby power automatic switch							■		
FC block	■		■	■	■	■			
Rear Ports	F	D2	TB	T	MD	M	B	C	UB
RS485 (2 ports)					■				
Ethernet (2 ports)					■				
USB(1 ports)					■				
Protocols	F	D2	TB	T	MD	M	B	C	UB
Modbus serial					■				
Modbus over Ethernet					■				
IEC 60870-5-103					■				
TCP IEC 60870-5-103					■				
IEC 60870-5-101					■				
Measurement	F	D2	TB	T	MD	M	B	C	UB
4-20mA analog output					■				
Electric parameter									U,Fr
Input current	8	6	8	8	9	8	8	8	0
Input voltage	4	0	4	4	4	4	6	4	8
Logs and Records	F	D2	TB	T	MD	M	B	C	UB
Fault recorder					■				
Numbers of circuit breaker trip and close					■				
Sequence of event record					■				
Monitoring Functions	F	D2	TB	T	MD	M	B	C	UB
Trip and close circuit supervision					■				
Remote control					■				
Others	F	D2	TB	T	MD	M	B	C	UB
GPS					■				

Note: ■standard □optional

• Wiring

① Typical configuration diagram

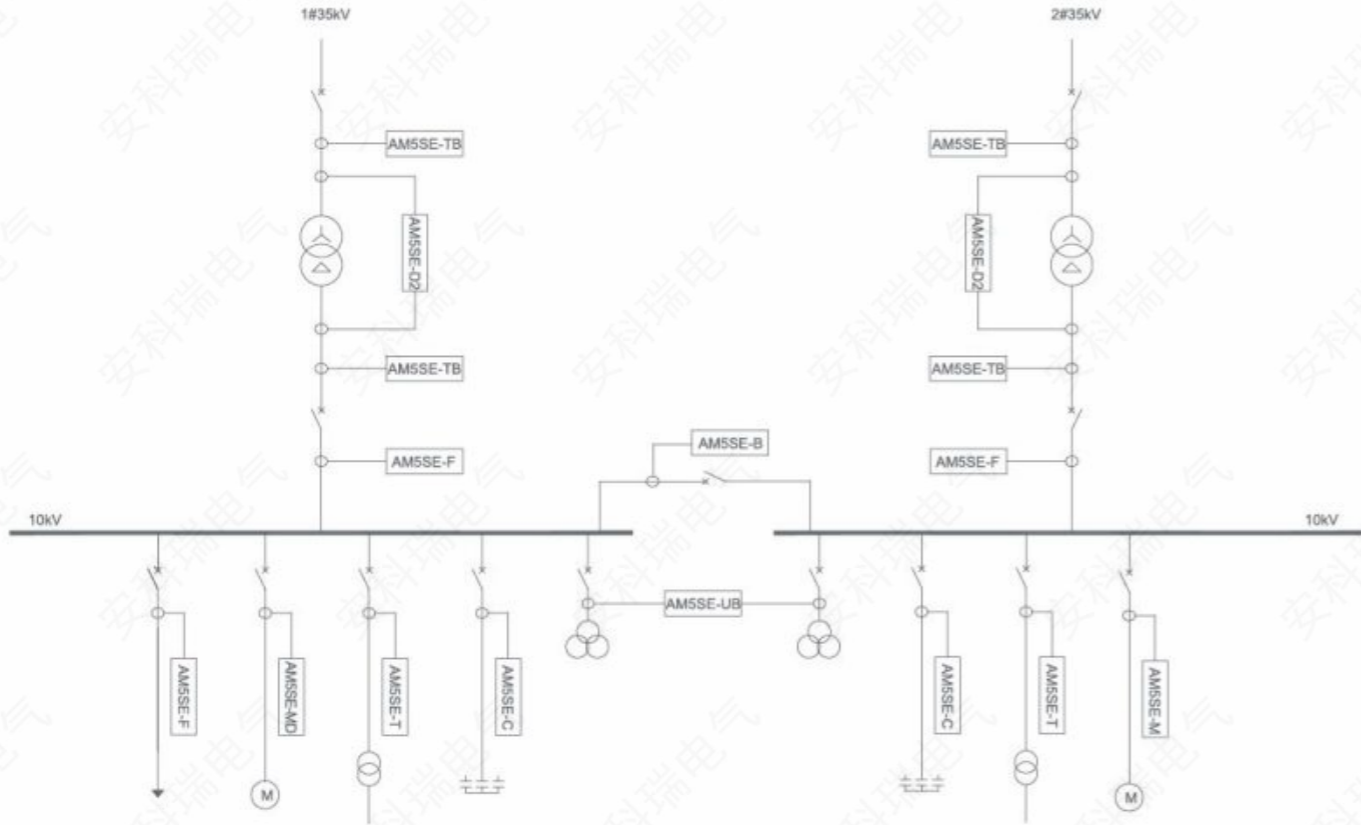

② Functional wiring diagram

AM5SE-UB:

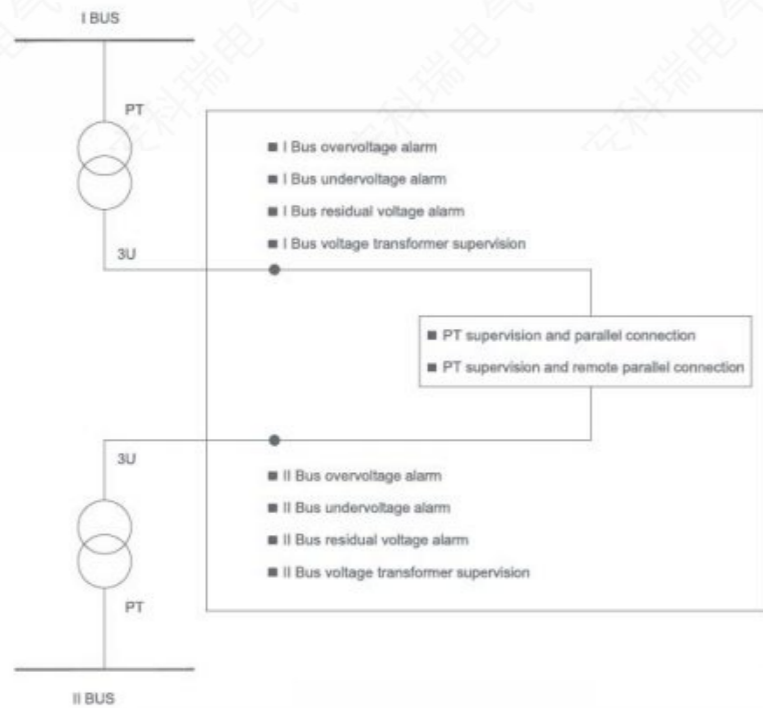

AM5SE-F:

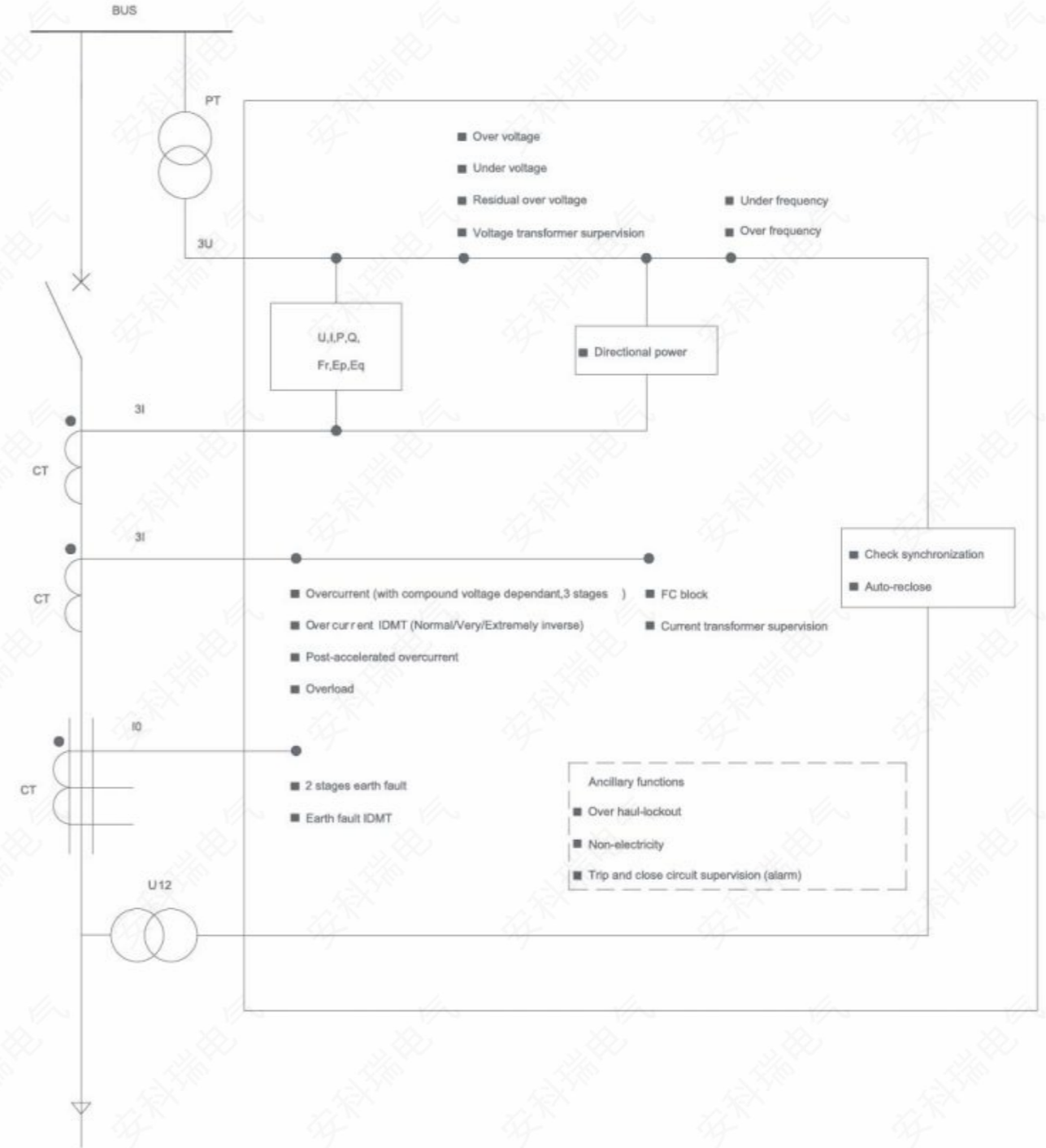

AM5SE-M:

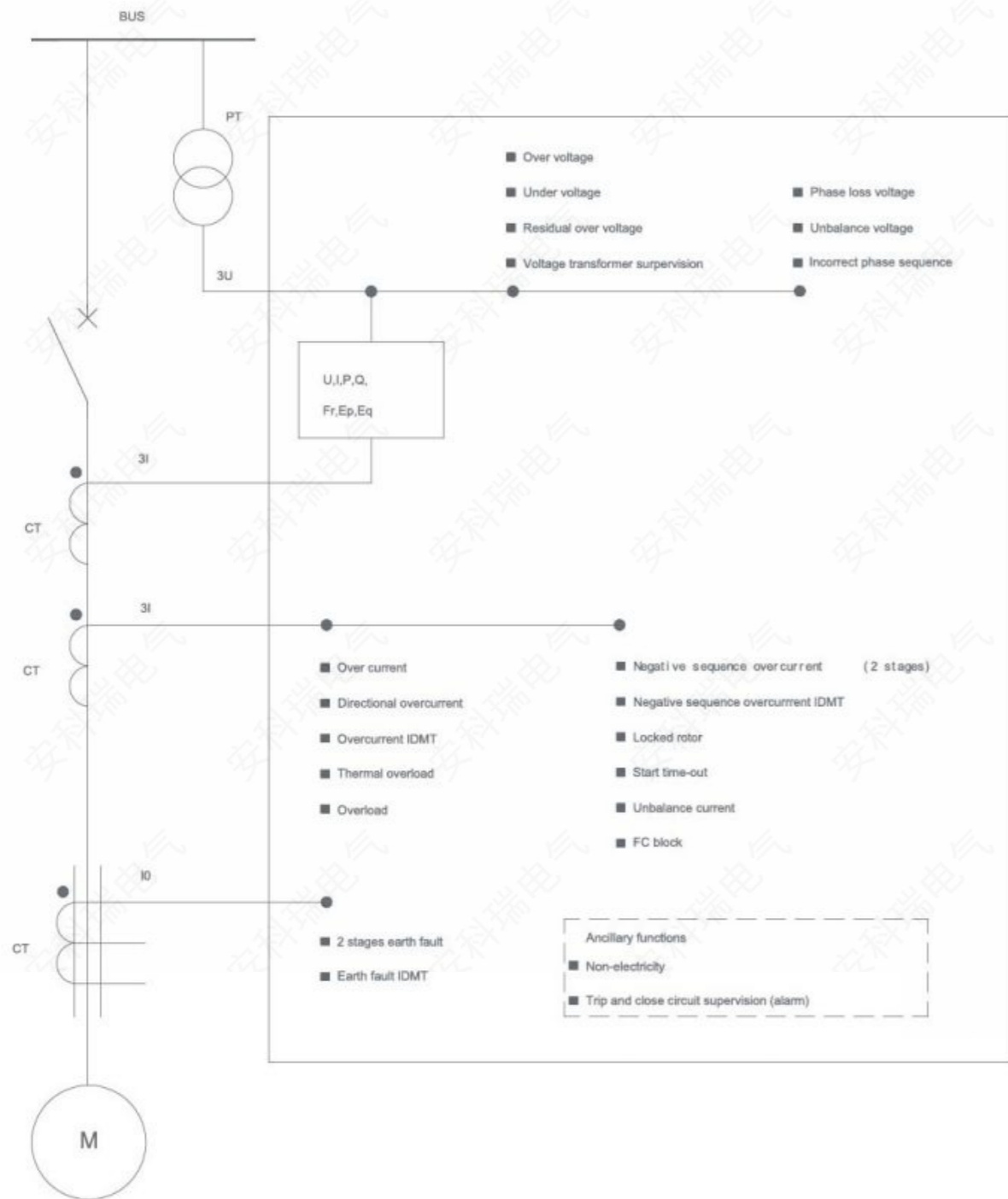

AM5SE-MD:

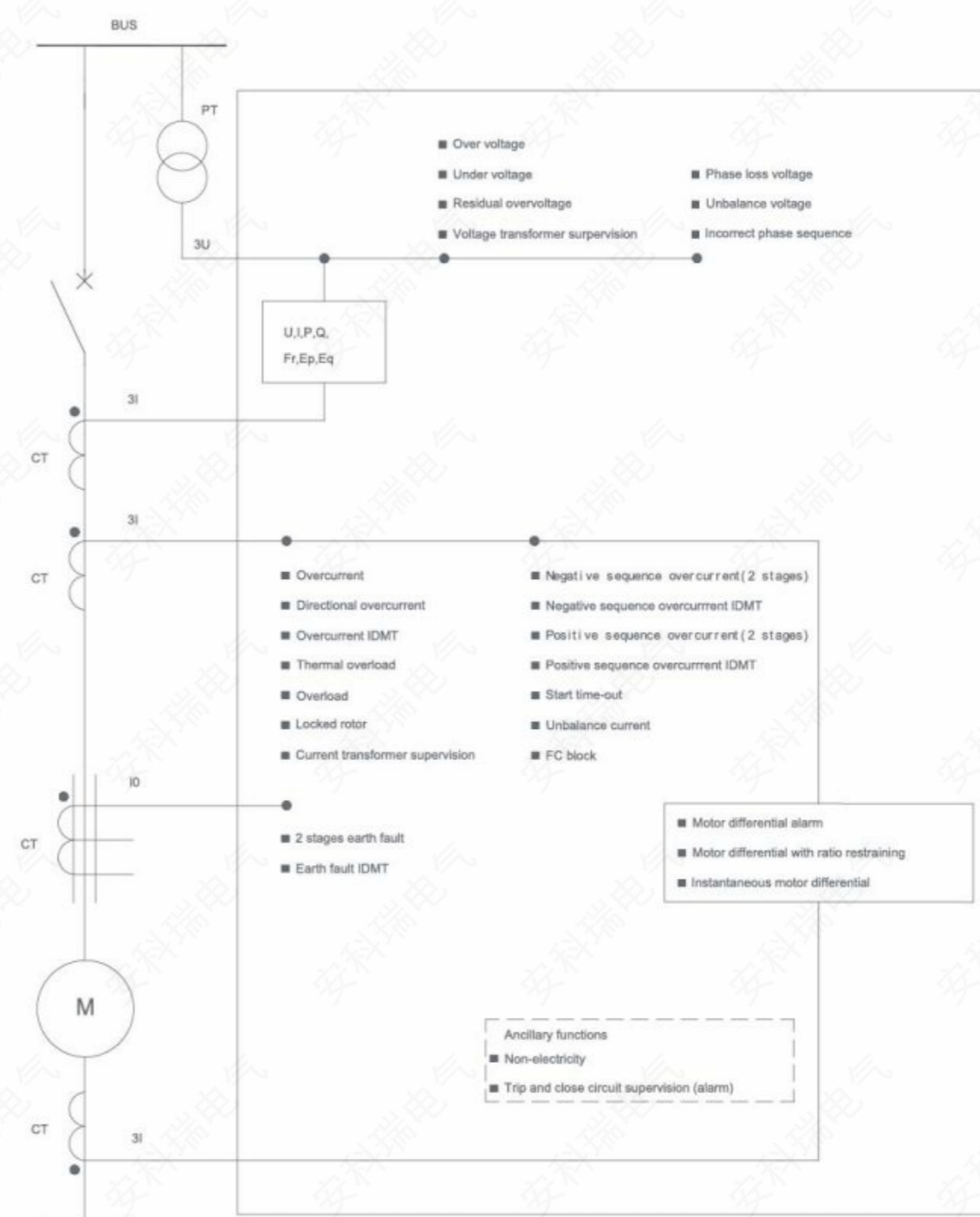

AM5SE-T:

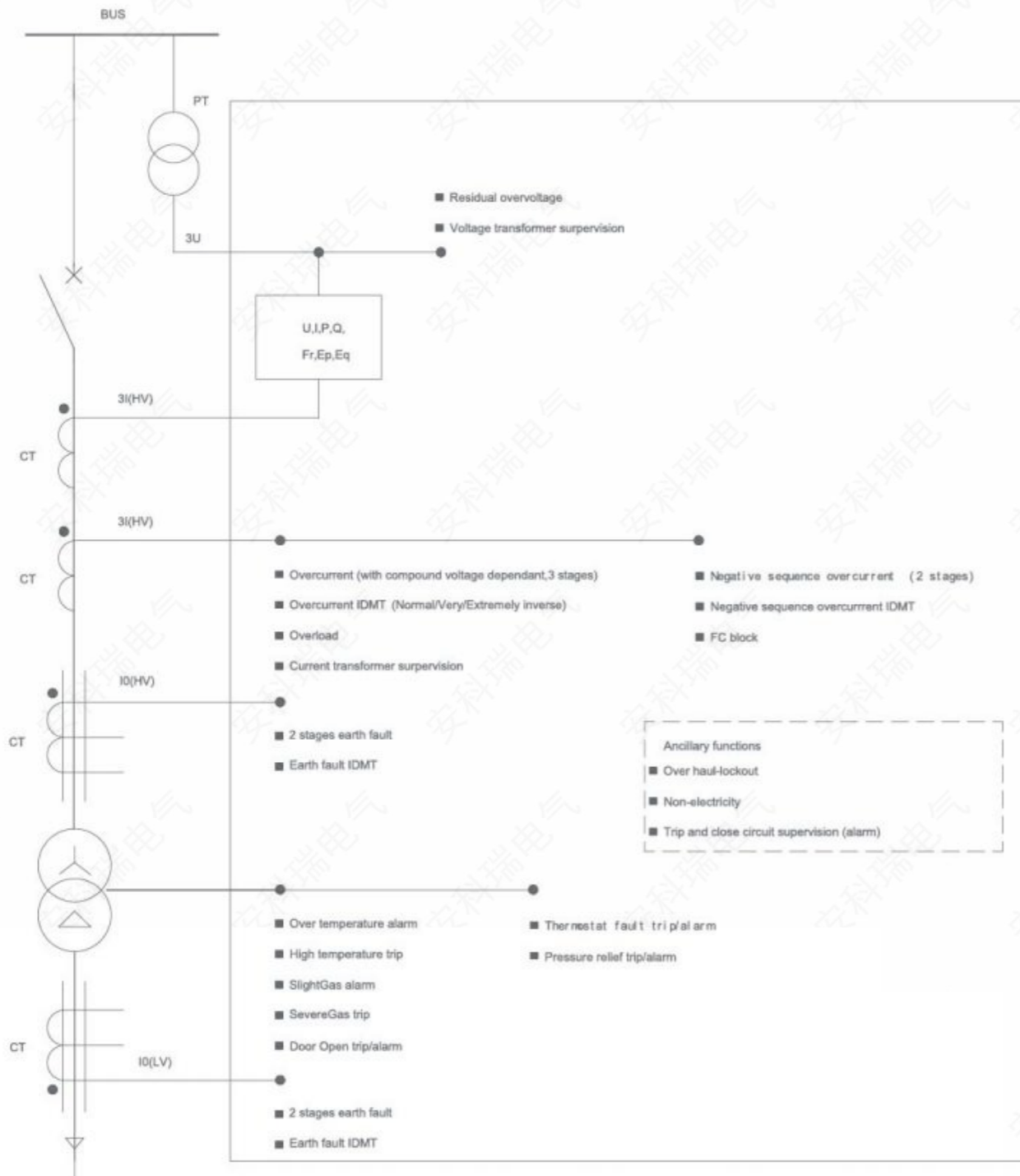

AM5SE-TB:

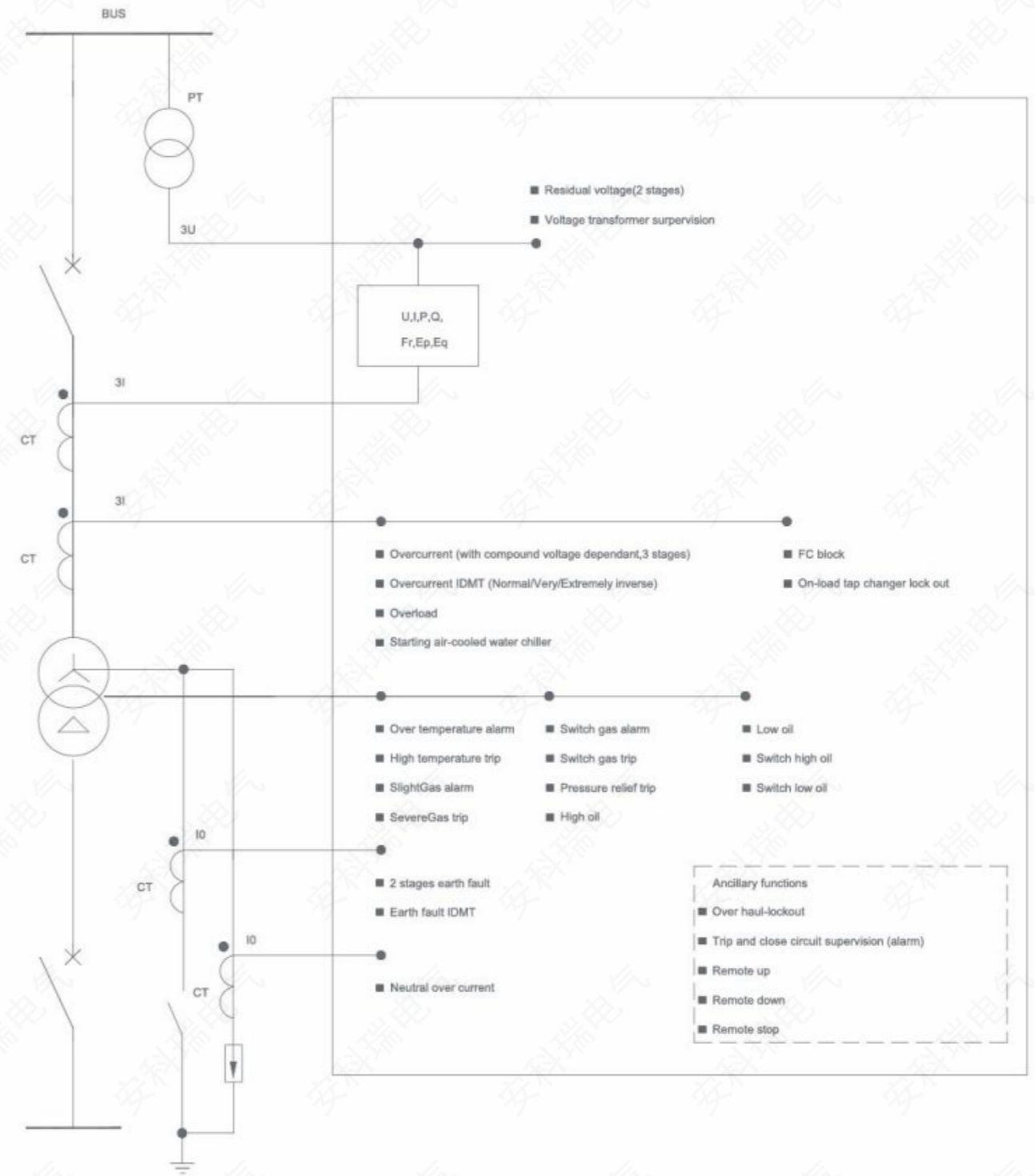

AM5SE-D2:

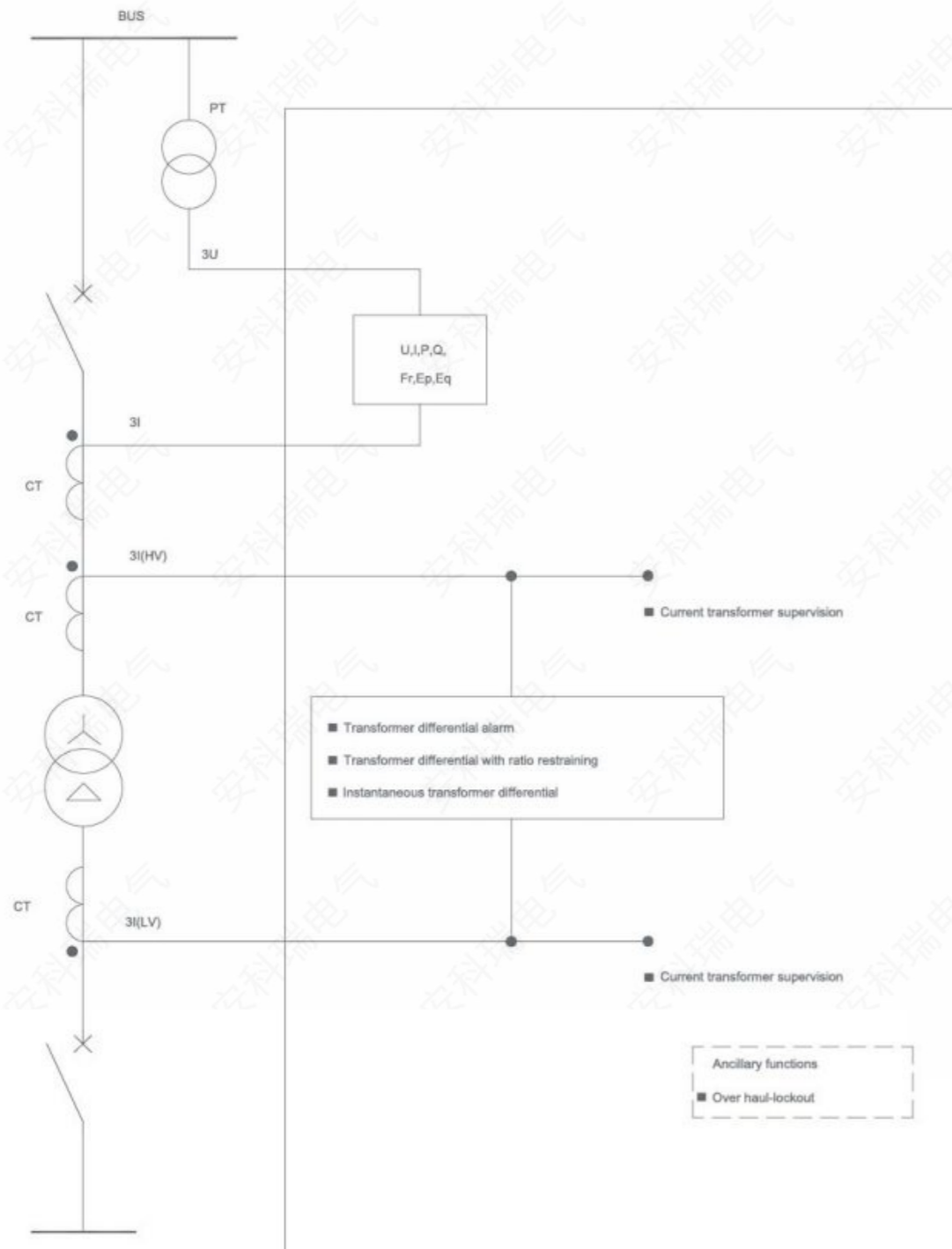

AM5SE-D3:

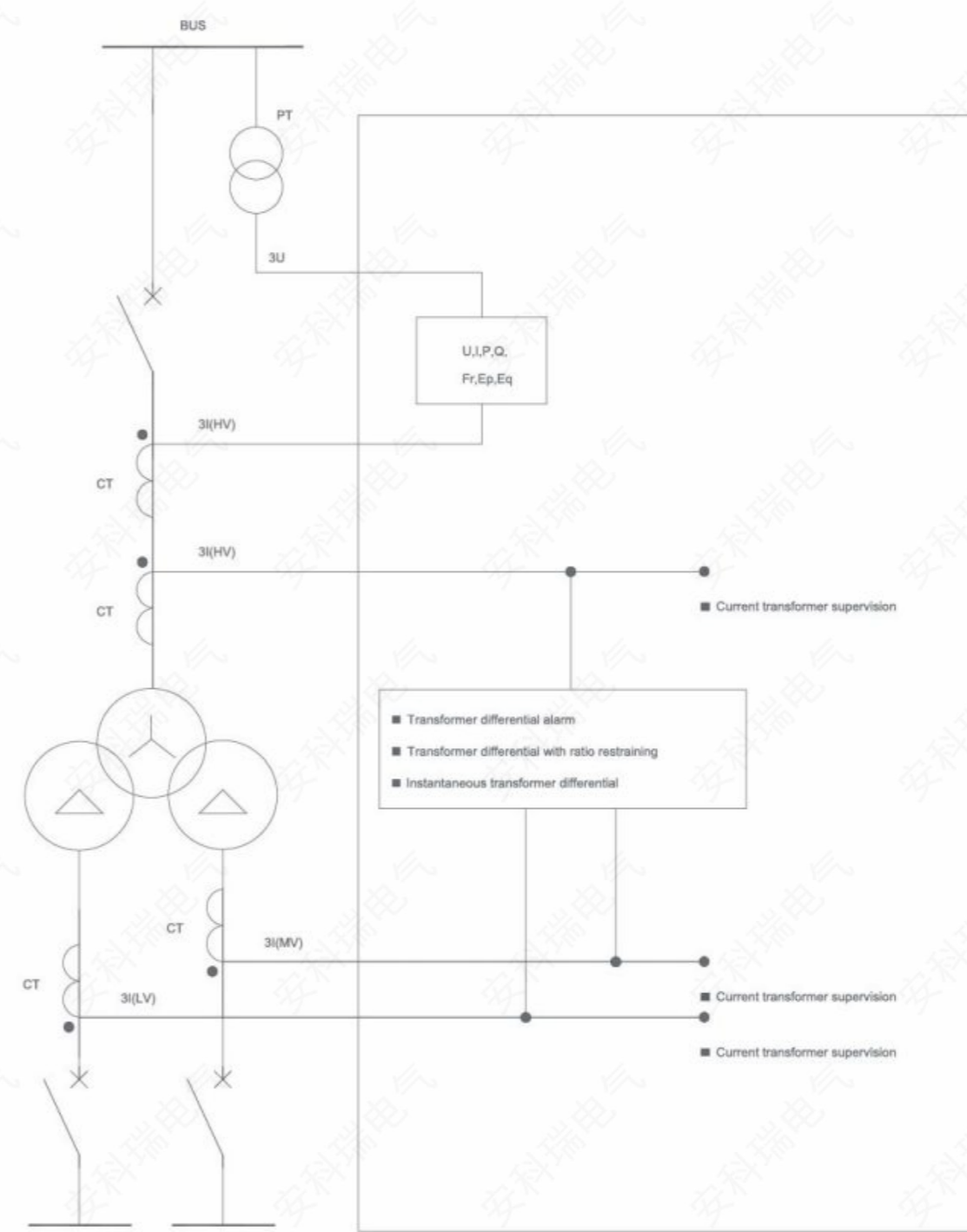

AM5SE-C:

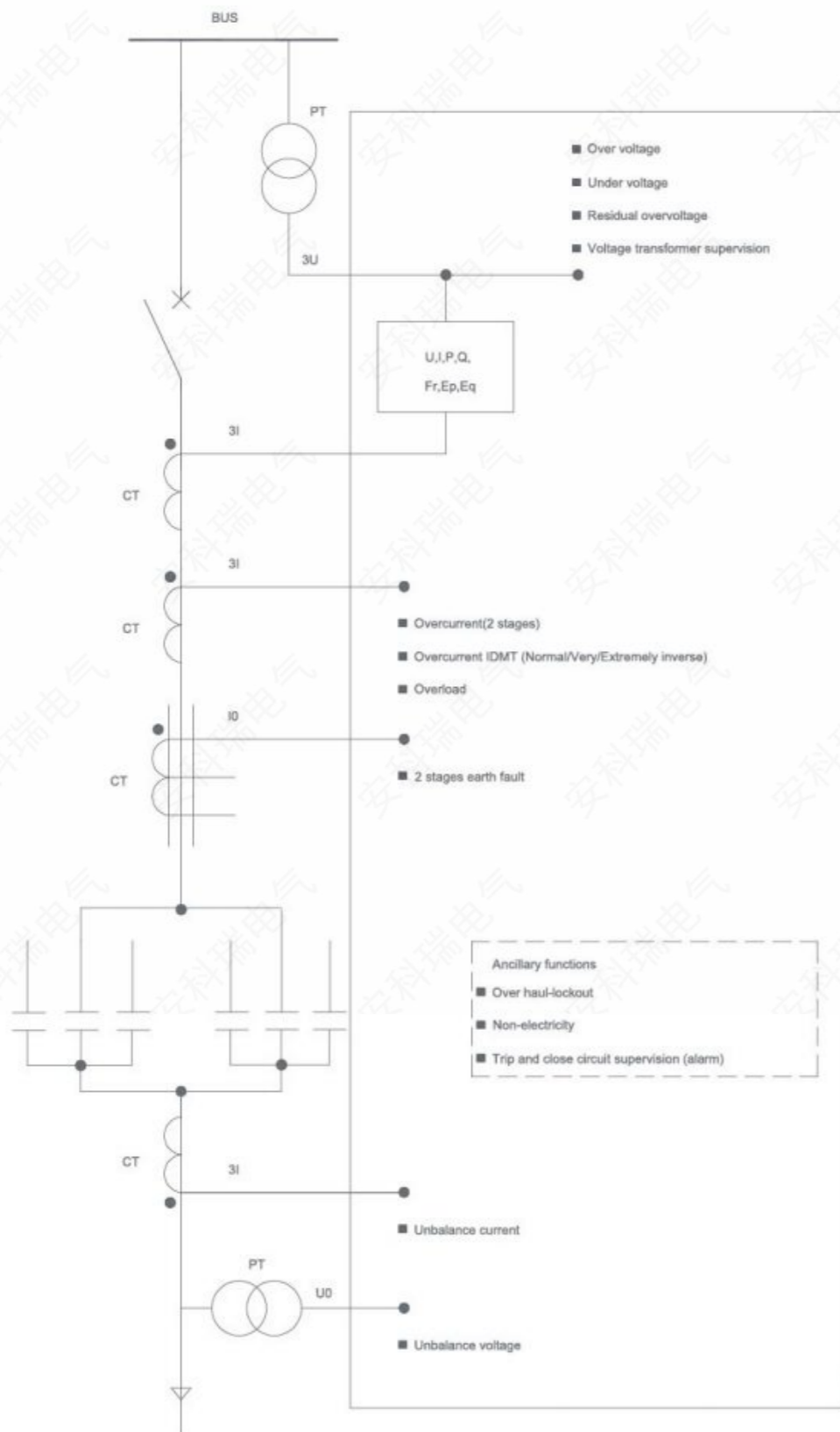

AM5SE-B:

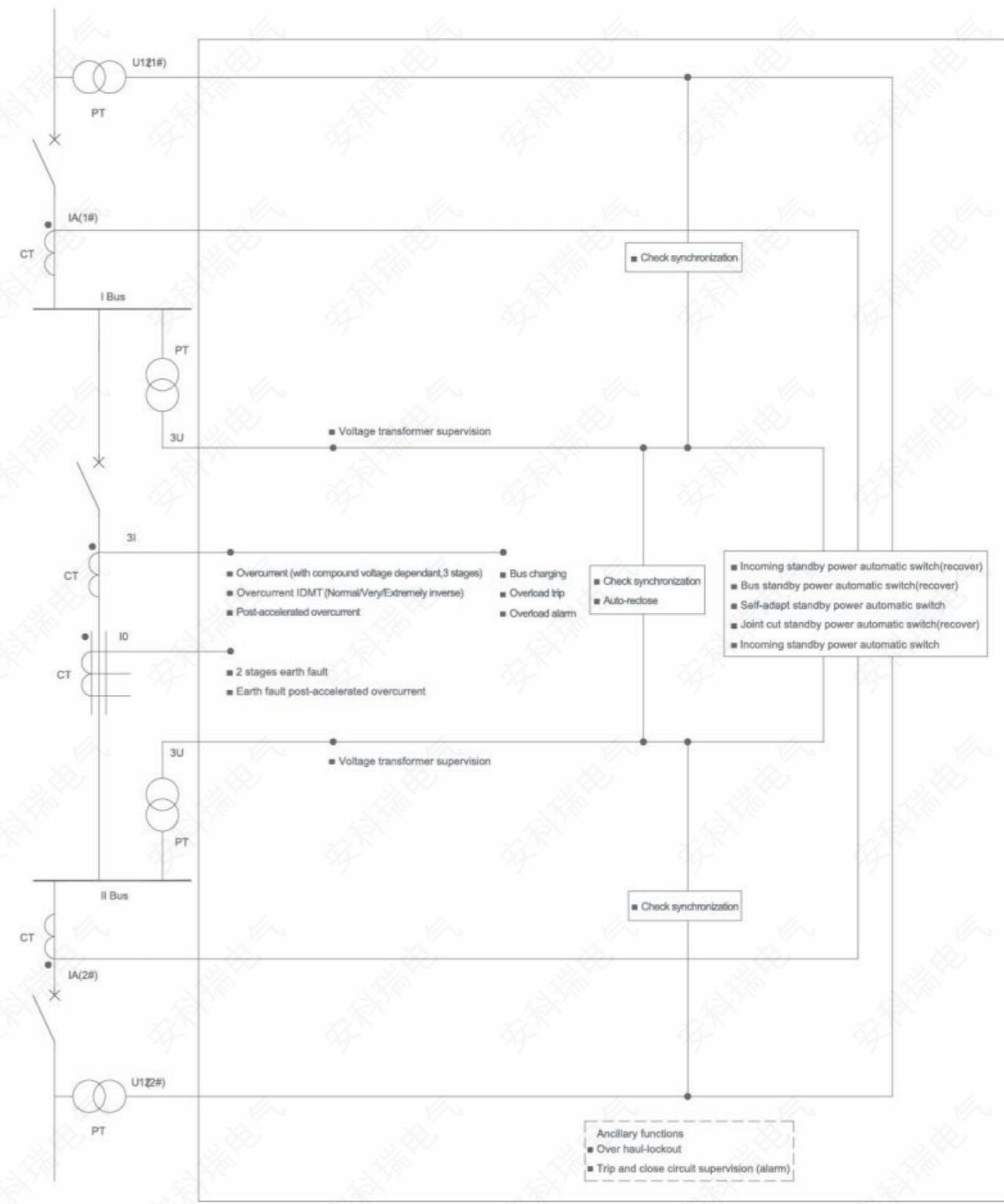

③ Wiring diagram

AM5SE-UB:

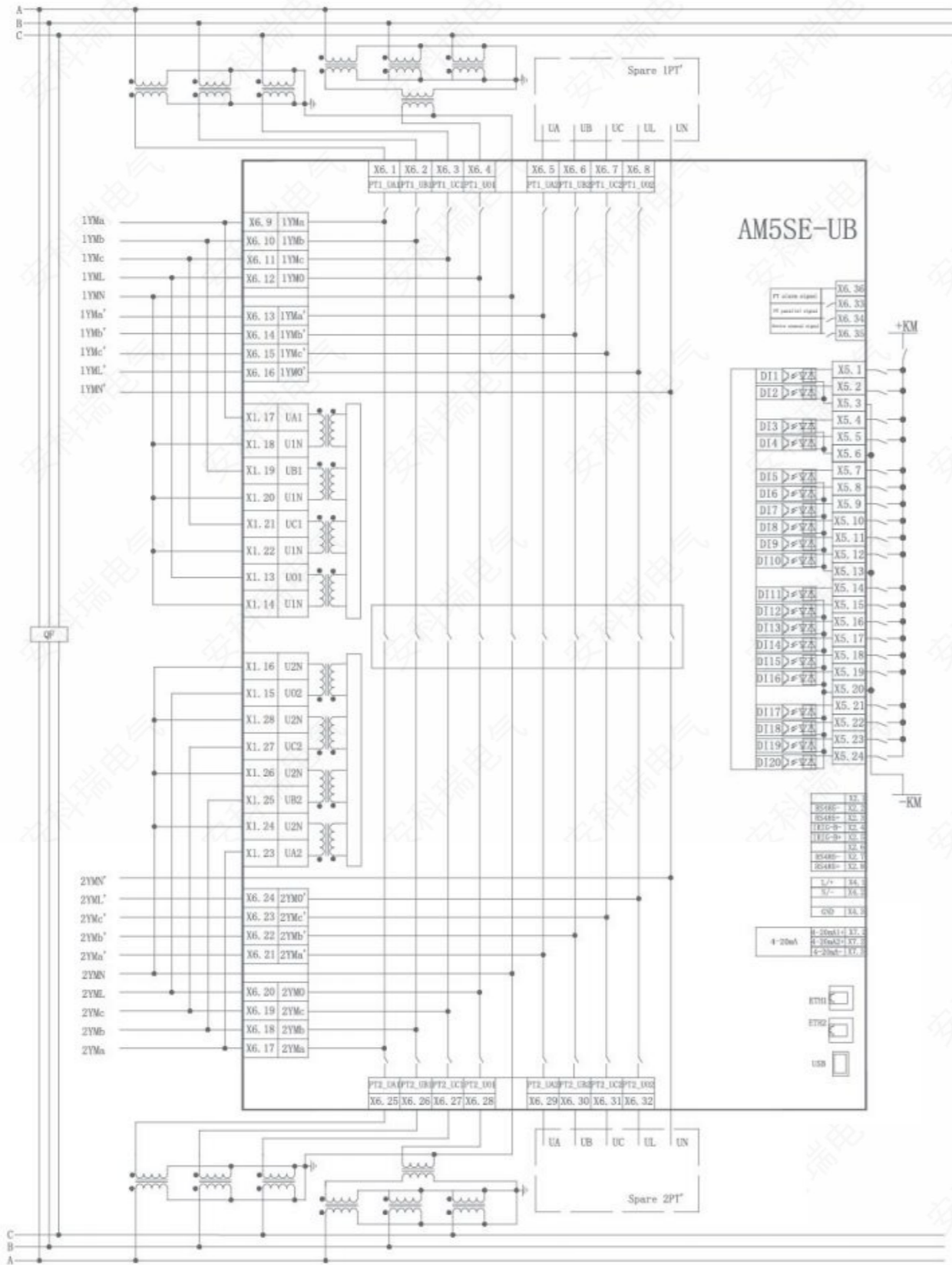

AM5SE-F:

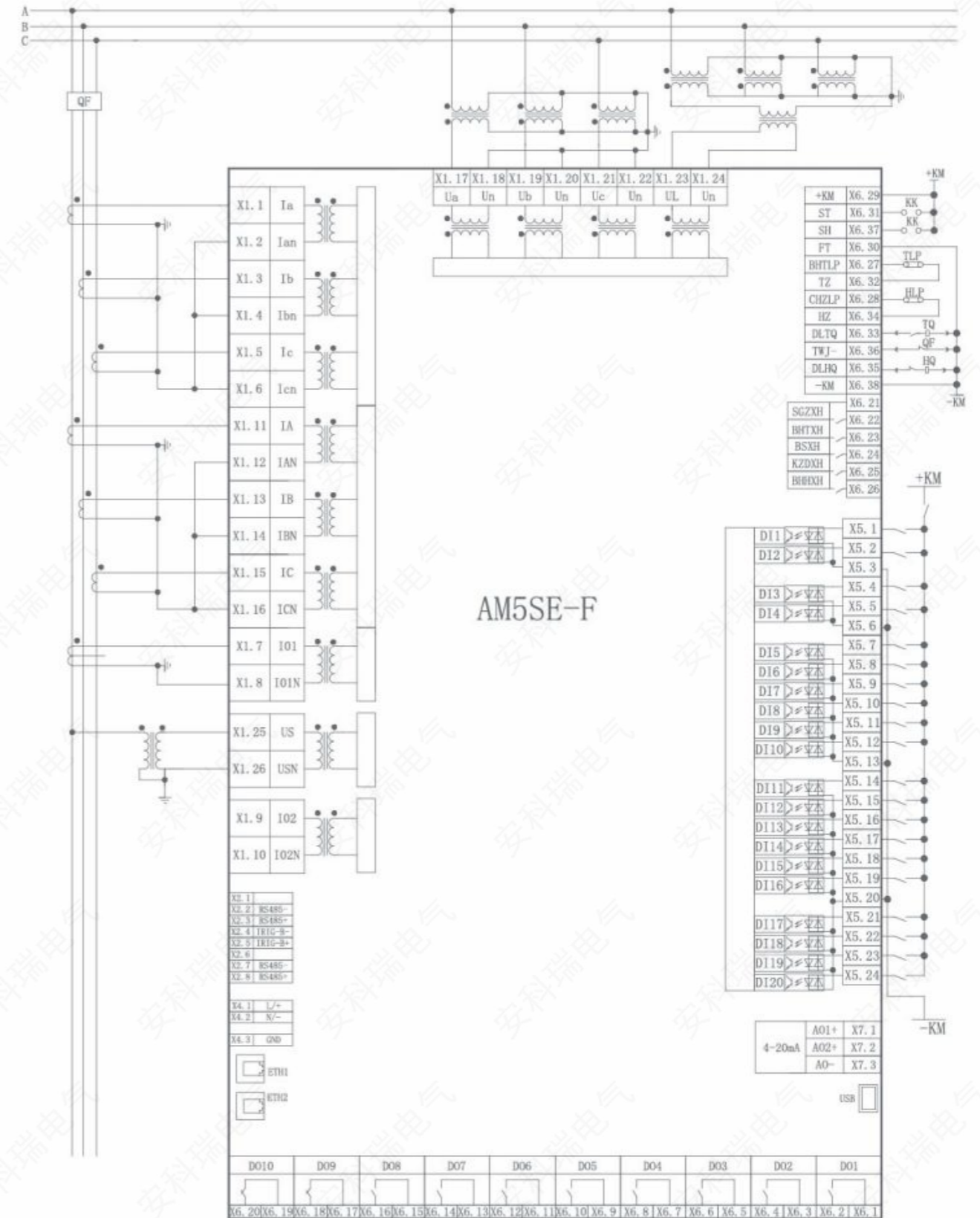

AM5SE-M:

AM5SE-MD:

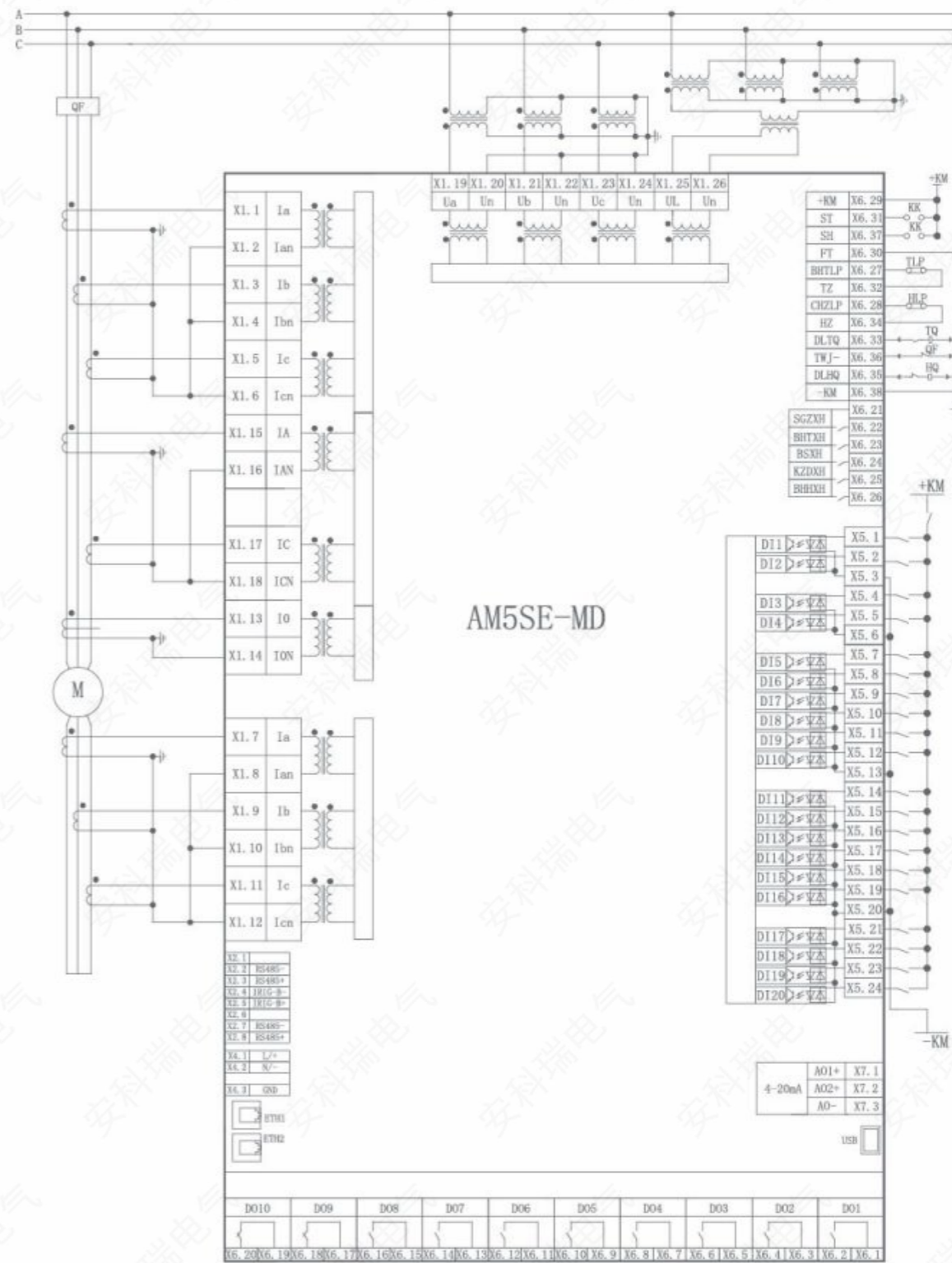
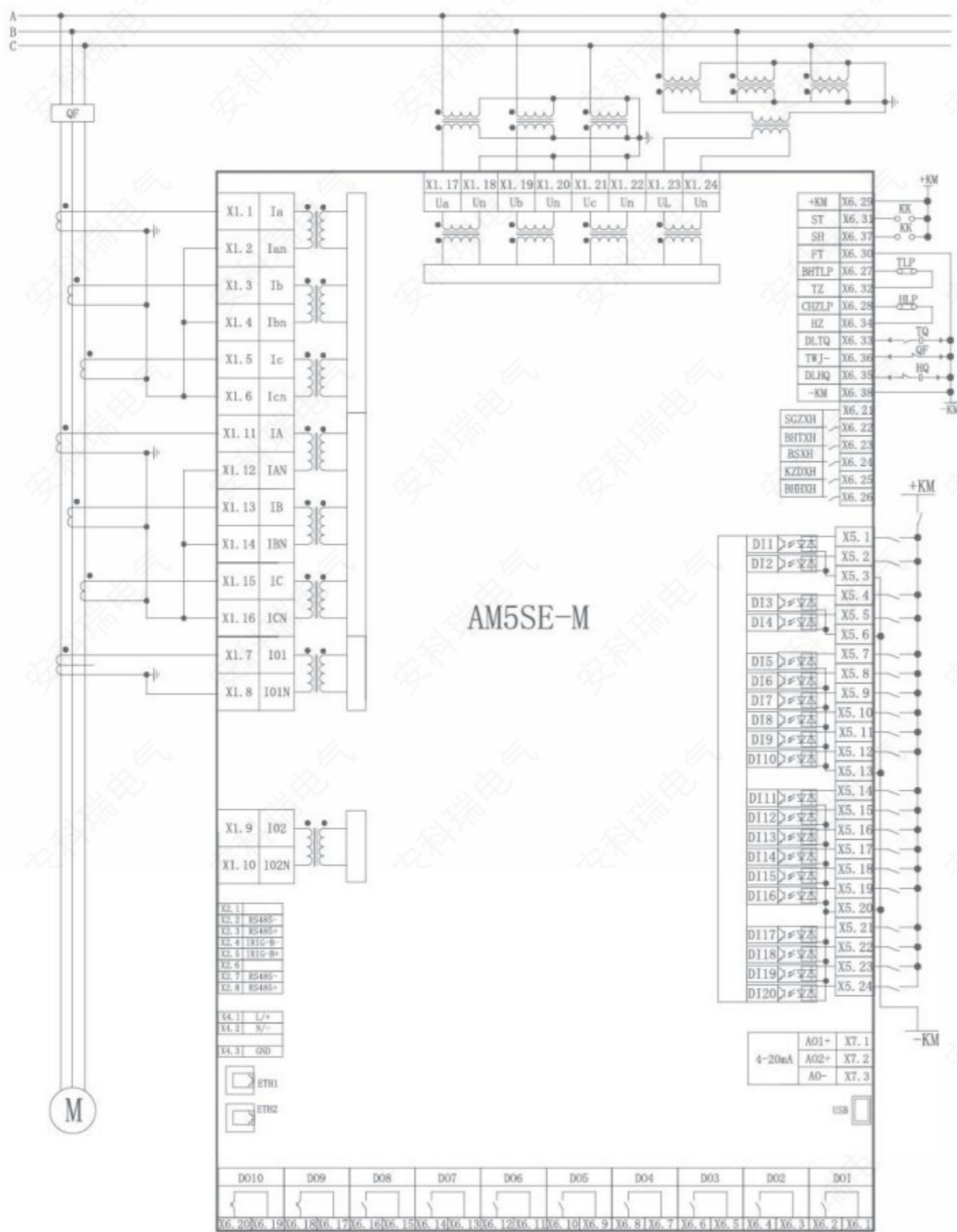

AM5SE-T:

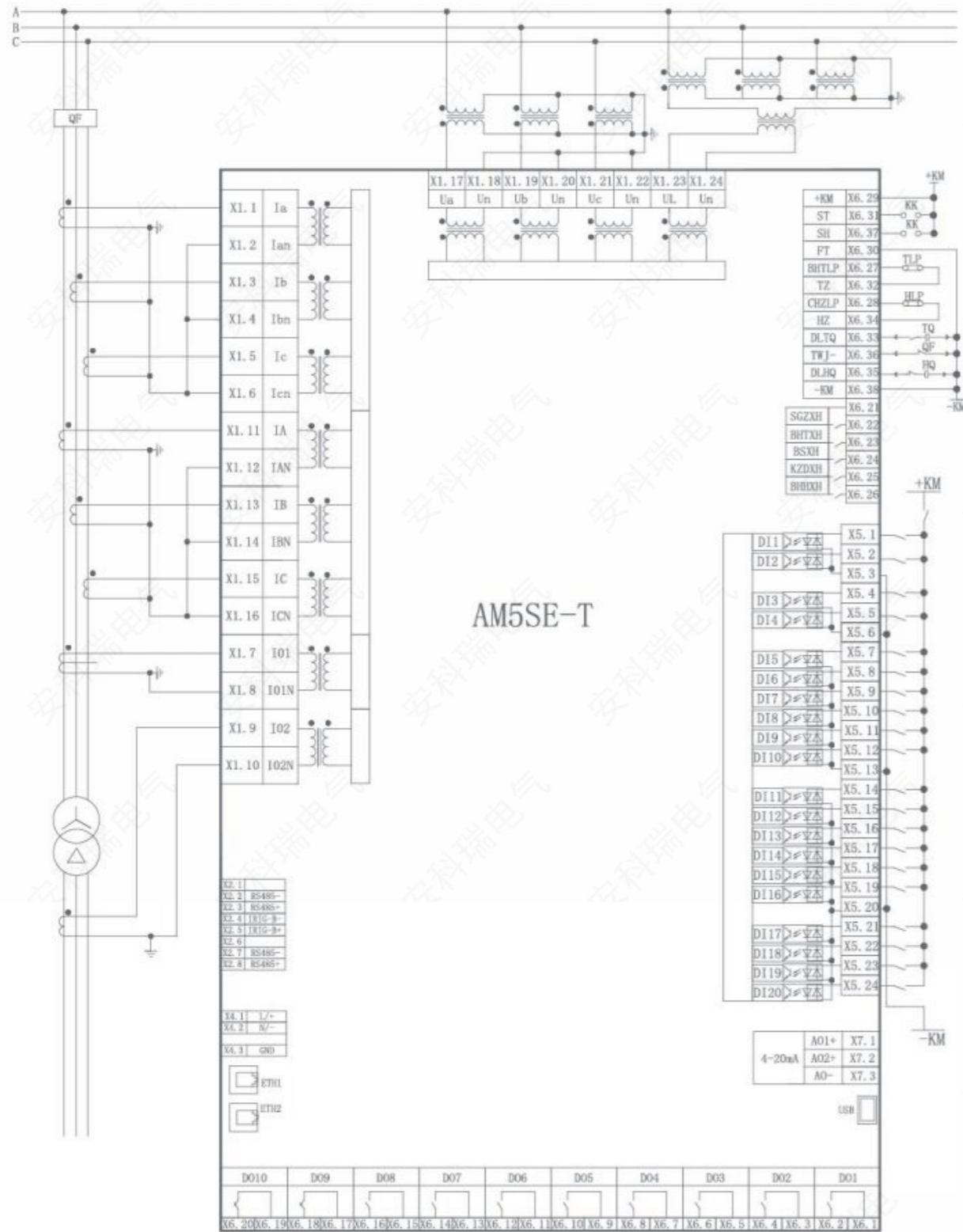

AM5SE-T

AM5SE-TB:

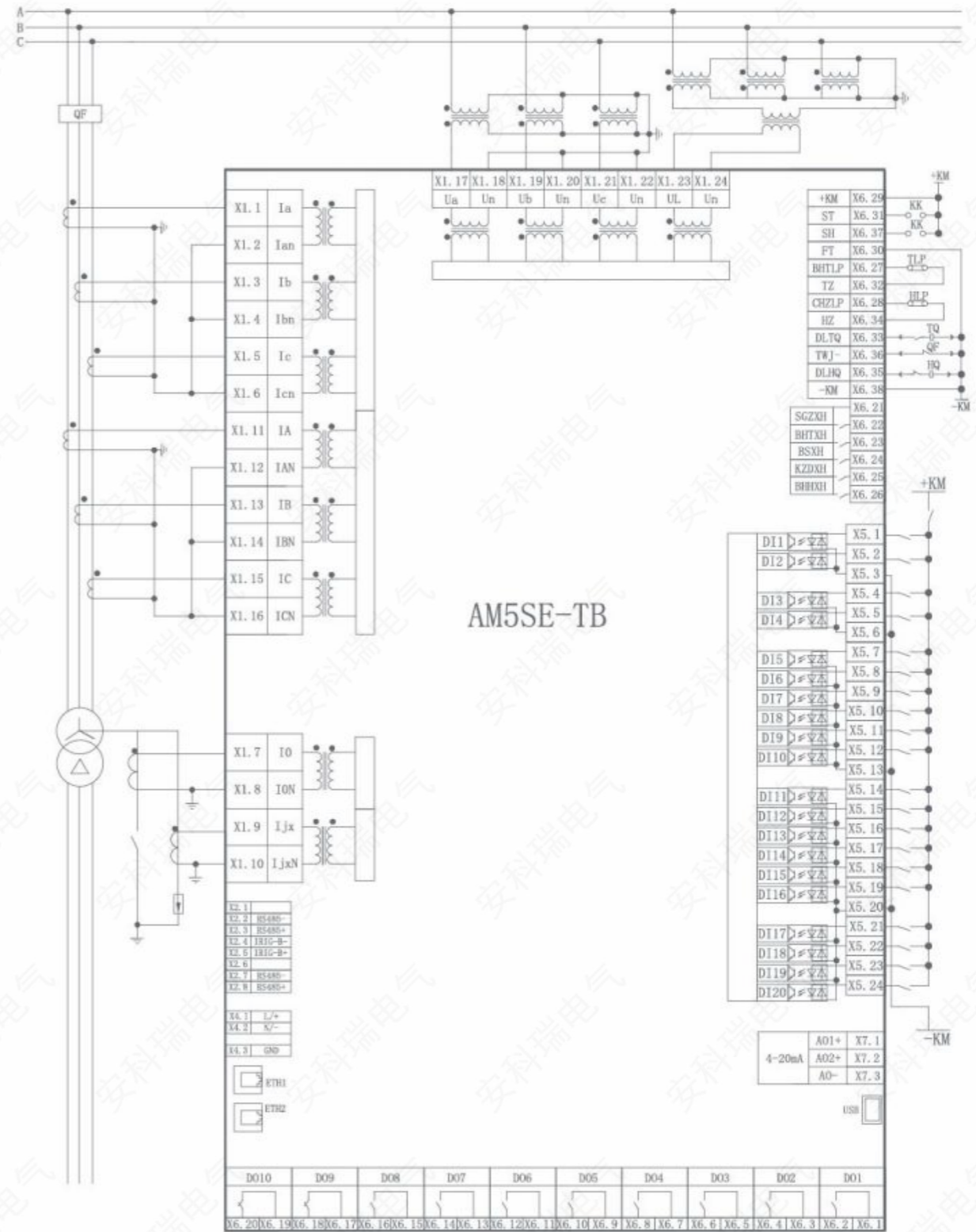

AM5SE-TB

AM5SE-D2:

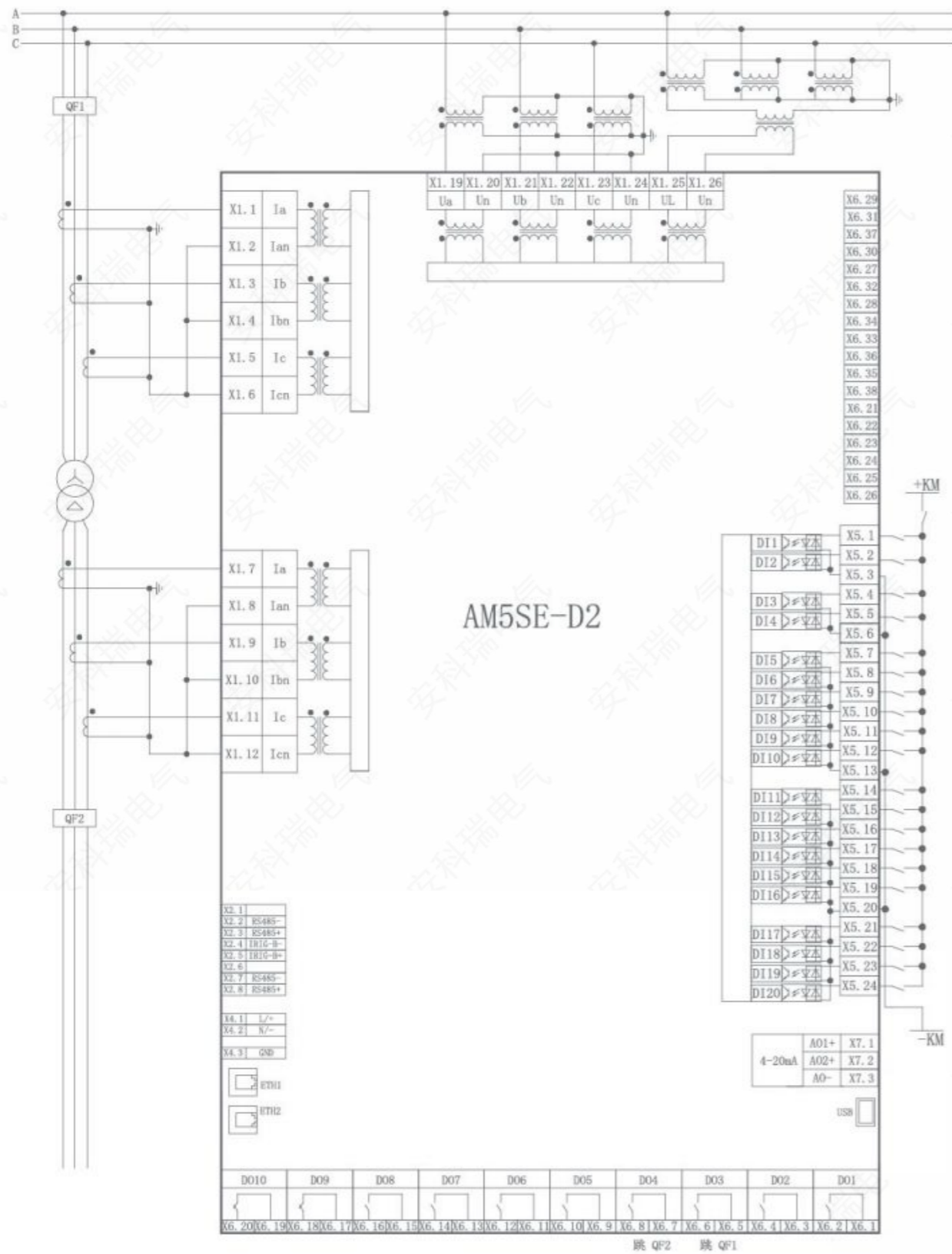

AM5SE-D3:

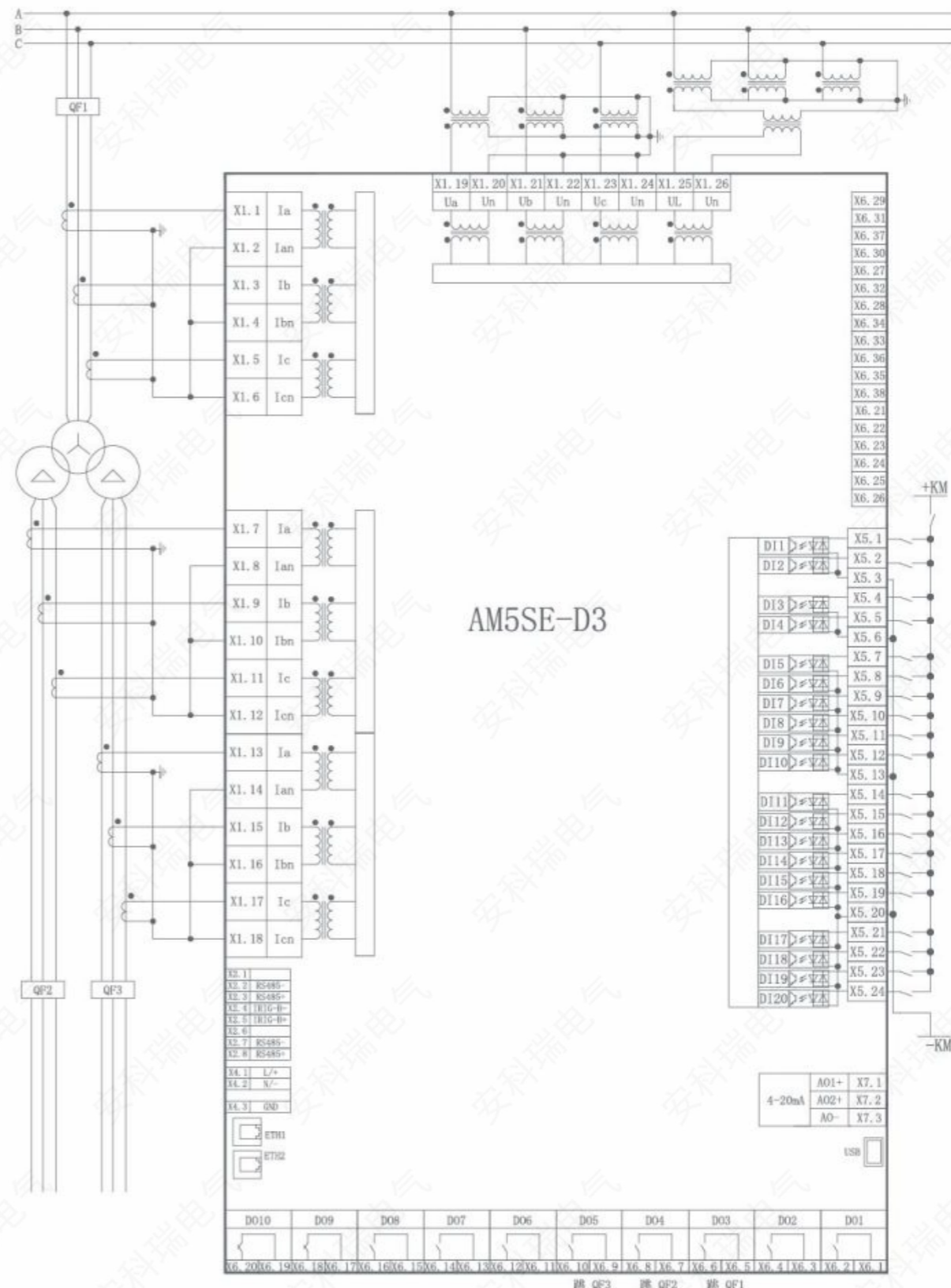

AM5SE-C:

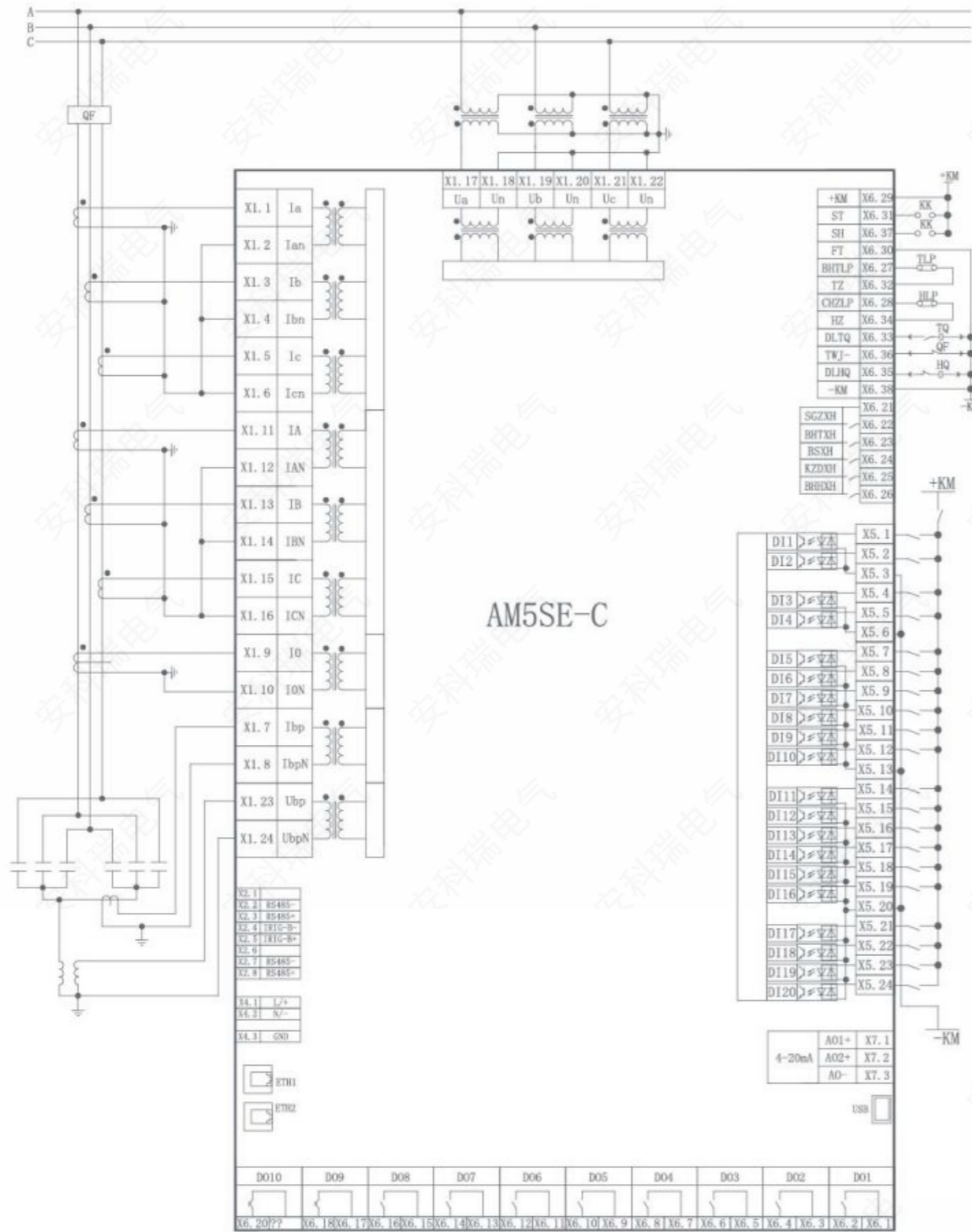

AM5SE-B:

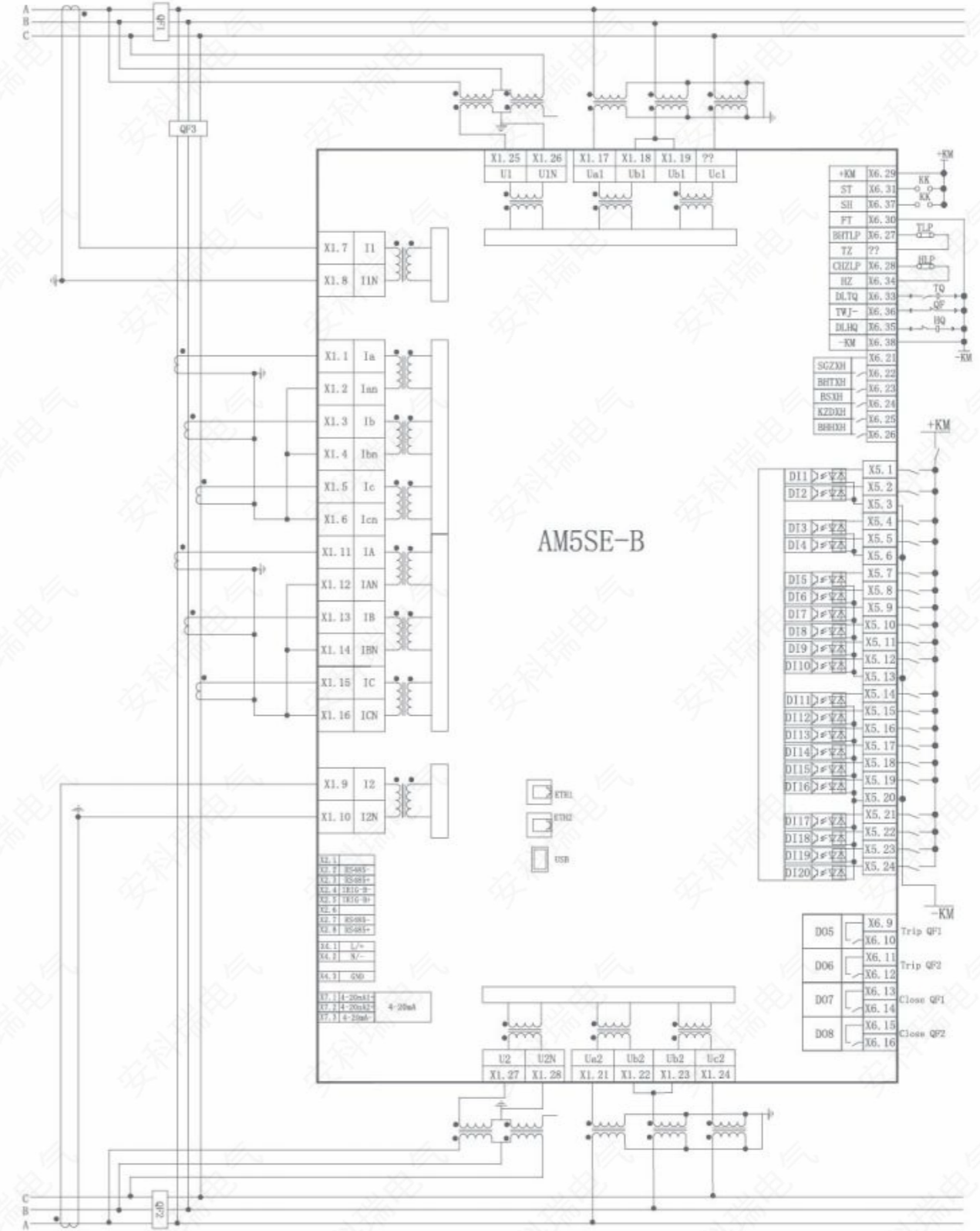

> 6.2 AM5 Series Protection Relay

• Model Description

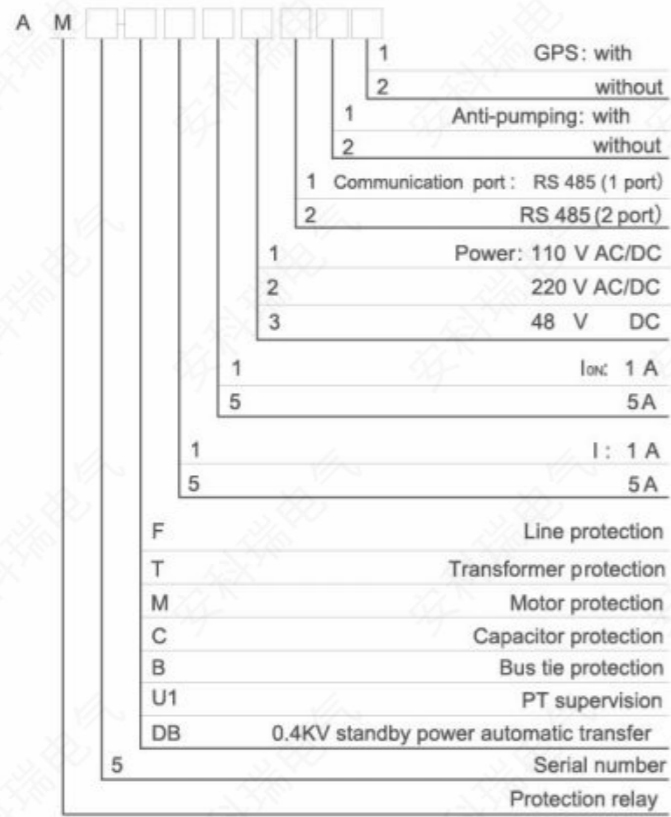

• Functions

Protection Functions	AM5-						
	F	T	M	C	B	U1	DB
Directional overcurrent (with voltage dependant, 3 stages)	■						
Overcurrent (with compound voltage dependant, 3 stages)		■					
Overcurrent (motor start,motor run, 2 stages)			■				
Overcurrent(2 stages)				■	■		
Overcurrent IDMT	■	■	■	■	■		
Earth fault	■	■	■	■			
Earth fault IDMT (I01)	■	■					
Earth fault IDMT (I02)	■	■					
Overload (alarm)	■	■	■				
Overload (trip)	■	■	■				
Trip and close circuit supervision (alarm)	■	■	■		■		

Protection Functions	AM5-						
	F	T	M	C	B	U1	DB
Undervoltage (trip)			■				
Undervoltage (alarm)						■	
Loss of voltage (trip)	■						
Loss of voltage (alarm)	■						
PT disconnection	■	■	■	■	■	■	
Three phase auto-reclose	■						
Under frequency	■						
Over frequency	■						
Post-accelerated overcurrent	■				■		
Overvoltage (alarm)	■					■	
Overvoltage (trip)	■			■			
Blocking rotor			■				
Capacitor undervoltage				■			
Unbalance voltage				■			
Unbalance current				■			
Residual overvoltage (trip)	■			■			
Residual overvoltage (alarm)	■		■			■	
Non-electricity		■	■	■			
Starting time-out			■				
Directional power	■						
Thermal overload (trip/alarm)			■				
Negative sequence overcurrent (2 stages/IDMT)			■				
Overvoltage average			■				
Overcurrent average			■				
Incorrect phase sequence			■				
Bus tie and standby power automatic switch					■		
0.4 kV standby power automatic switch							■
FC block	■	■	■	■			
Rear ports	F	T	M	C	B	U1	DB
RS485 (2 ports)				■			
Protocols	F	T	M	C	B	U1	DB

Protection Functions	AM5-							
	F	T	M	C	B	U1	DB	
Modbus serial				■				
IEC 60870-5-103				■				
IEC 60870-5-101				■				
Logs and Records	F	T	M	C	B	U1	DB	
Tripping context records				■				
Sequence of event records				■				
Measurement	F	T	M	C	B	U1	DB	
Electric parameter	U、I、P、Q、PF、F							
Input Current	8	8	8	8	8	0	8	
Input Voltage	4	4	4	4	4	4	4	
Monitoring functions	F	T	M	C	B	U1	DB	
Anti-pumping circuit	Optional							
Remote control				■				
Others	F	T	M	C	B	U1	DB	
GPS				■				

Note: ■standard □optional

• Wiring

① Typical configuration diagram

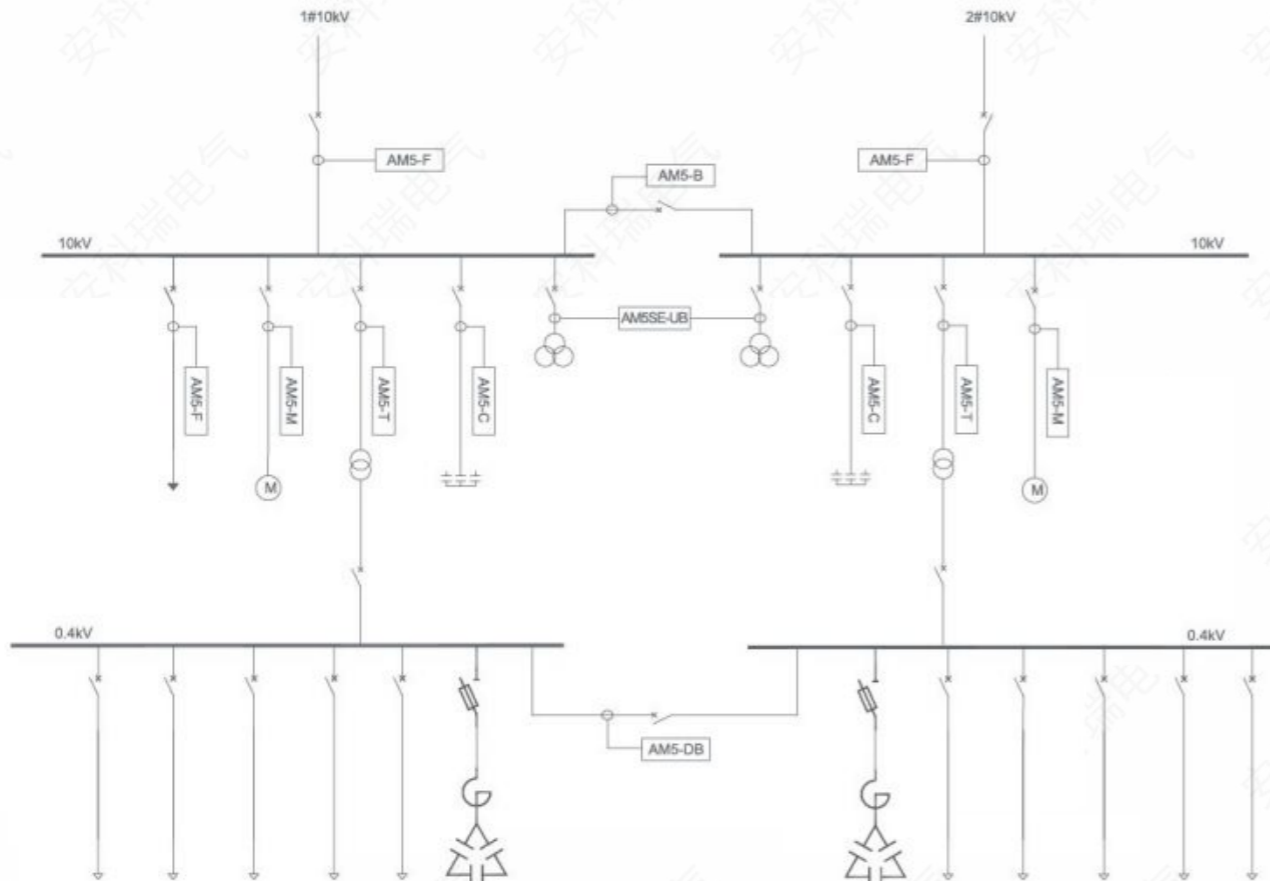

② Functional wiring diagram

AM5-F:

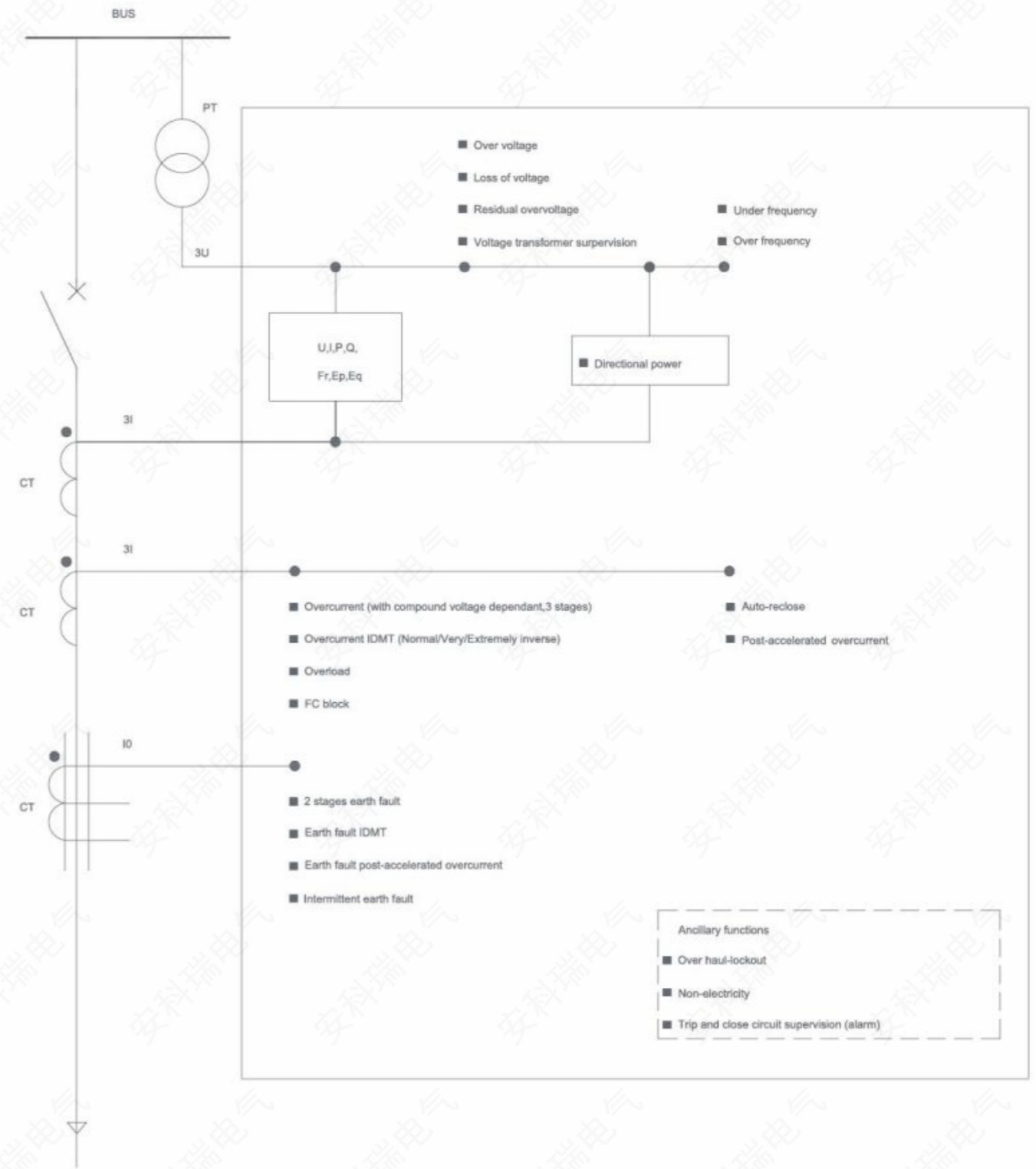

AM5-M:

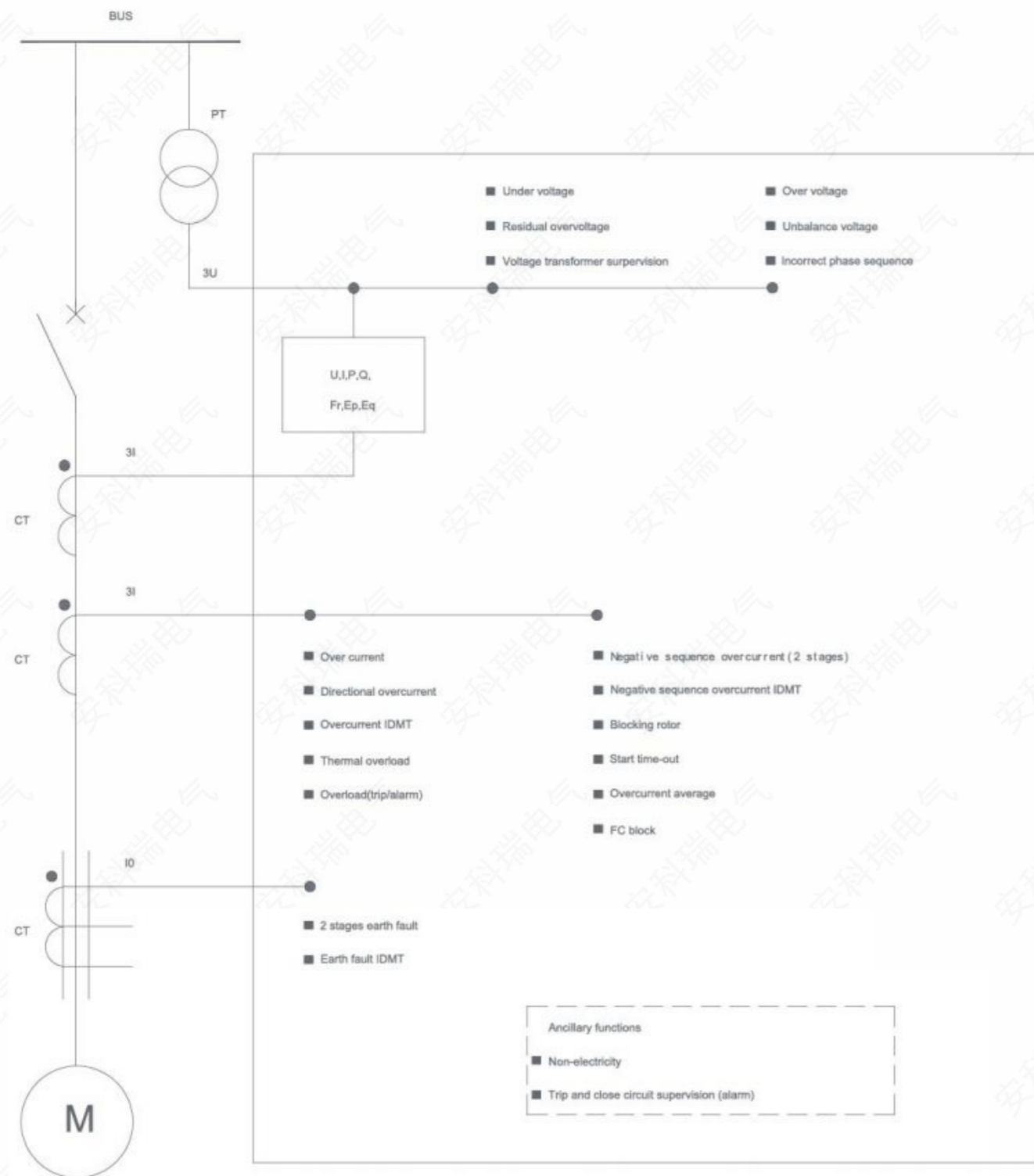

AM5-C:

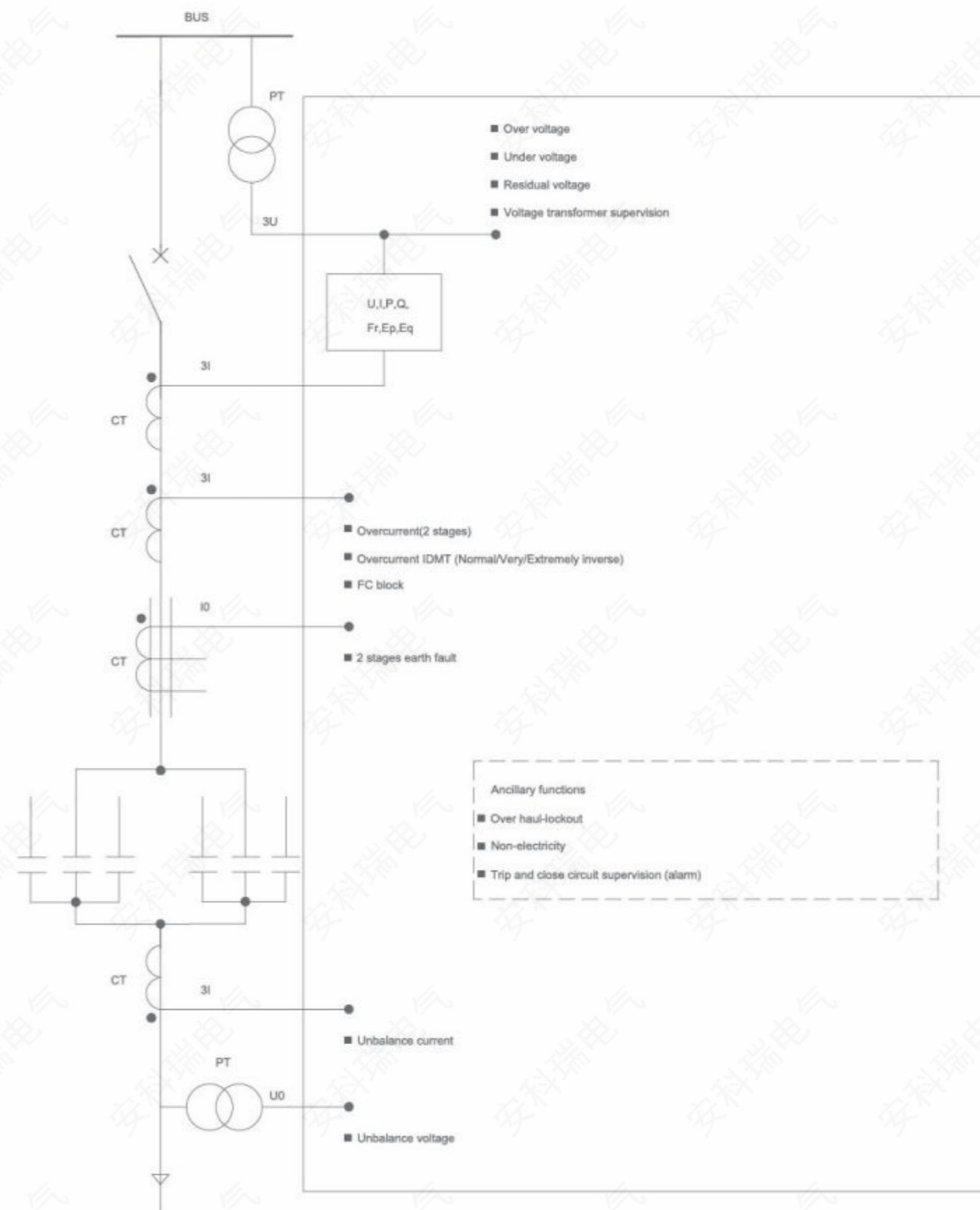

AM5-T:

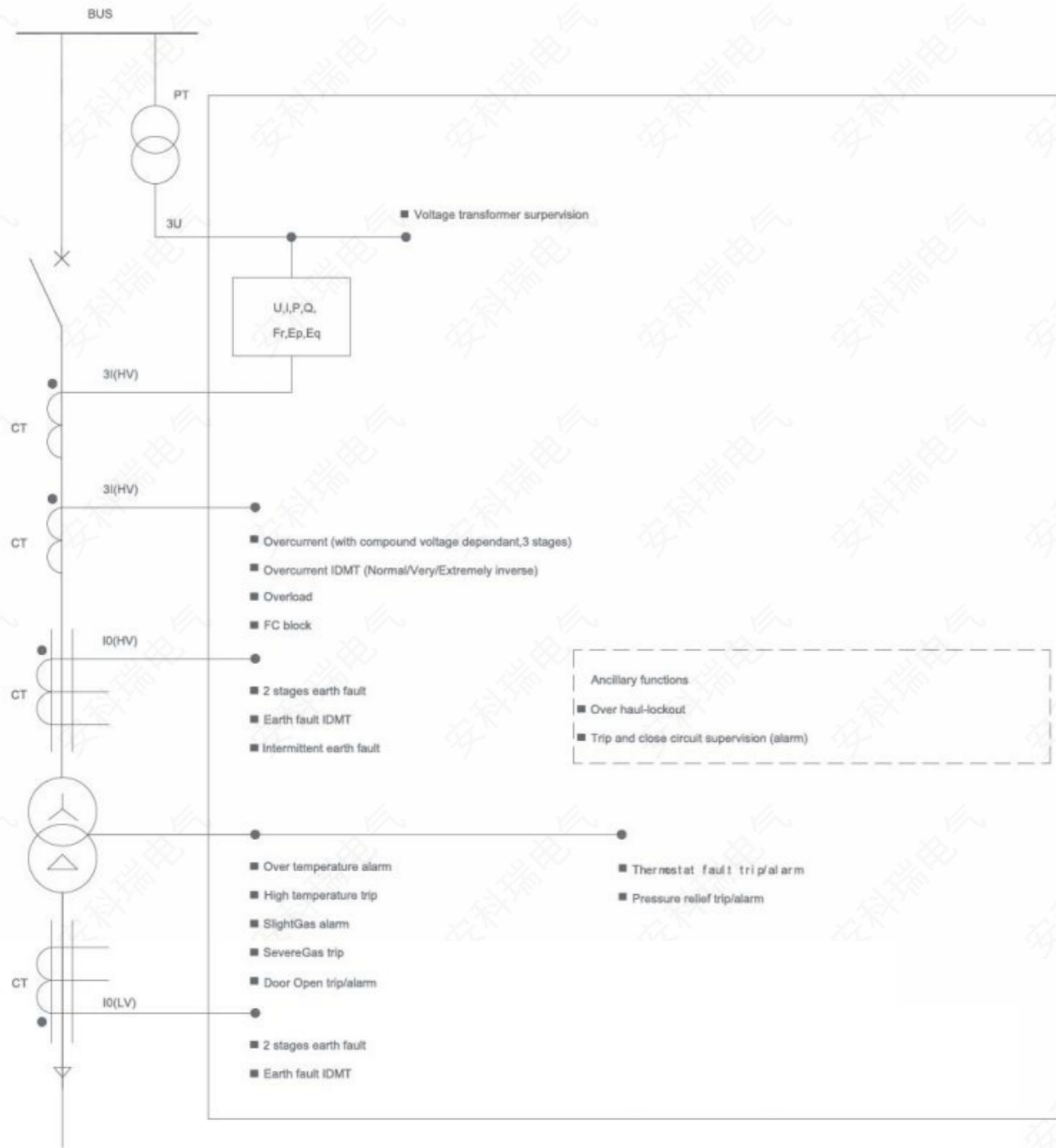

AM5-U1:

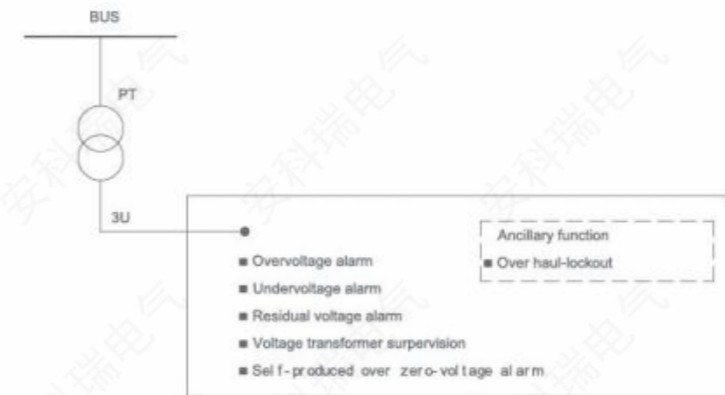

AM5-DB:

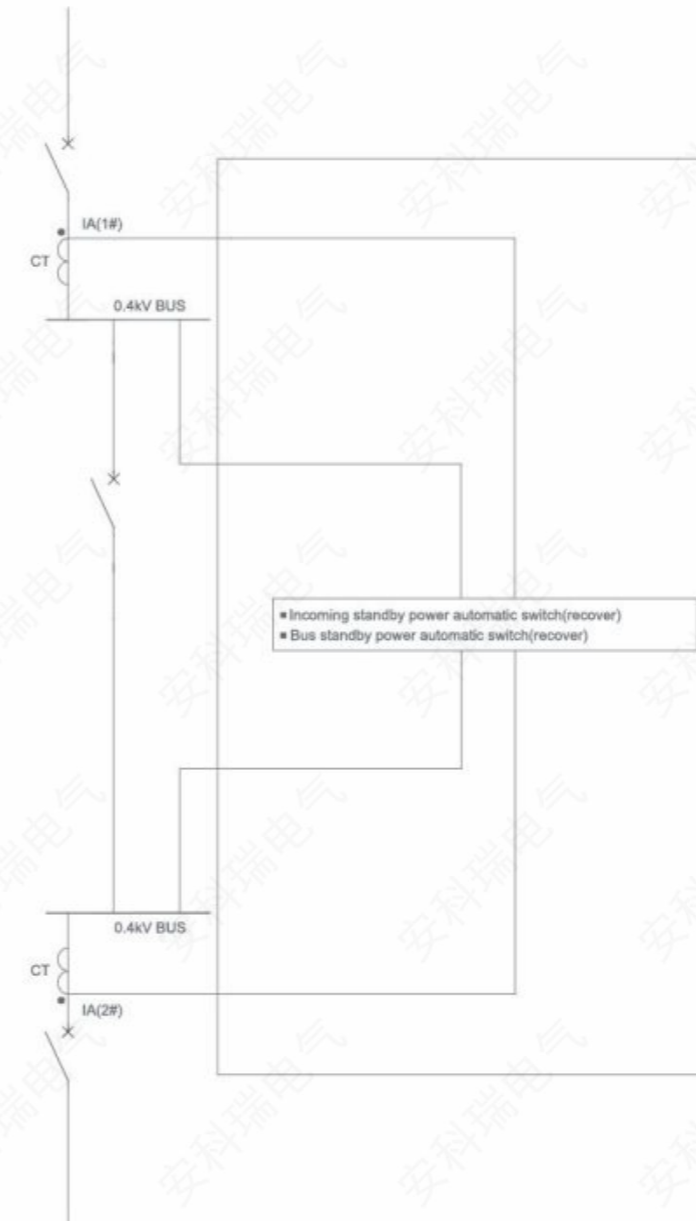

AM5-B:

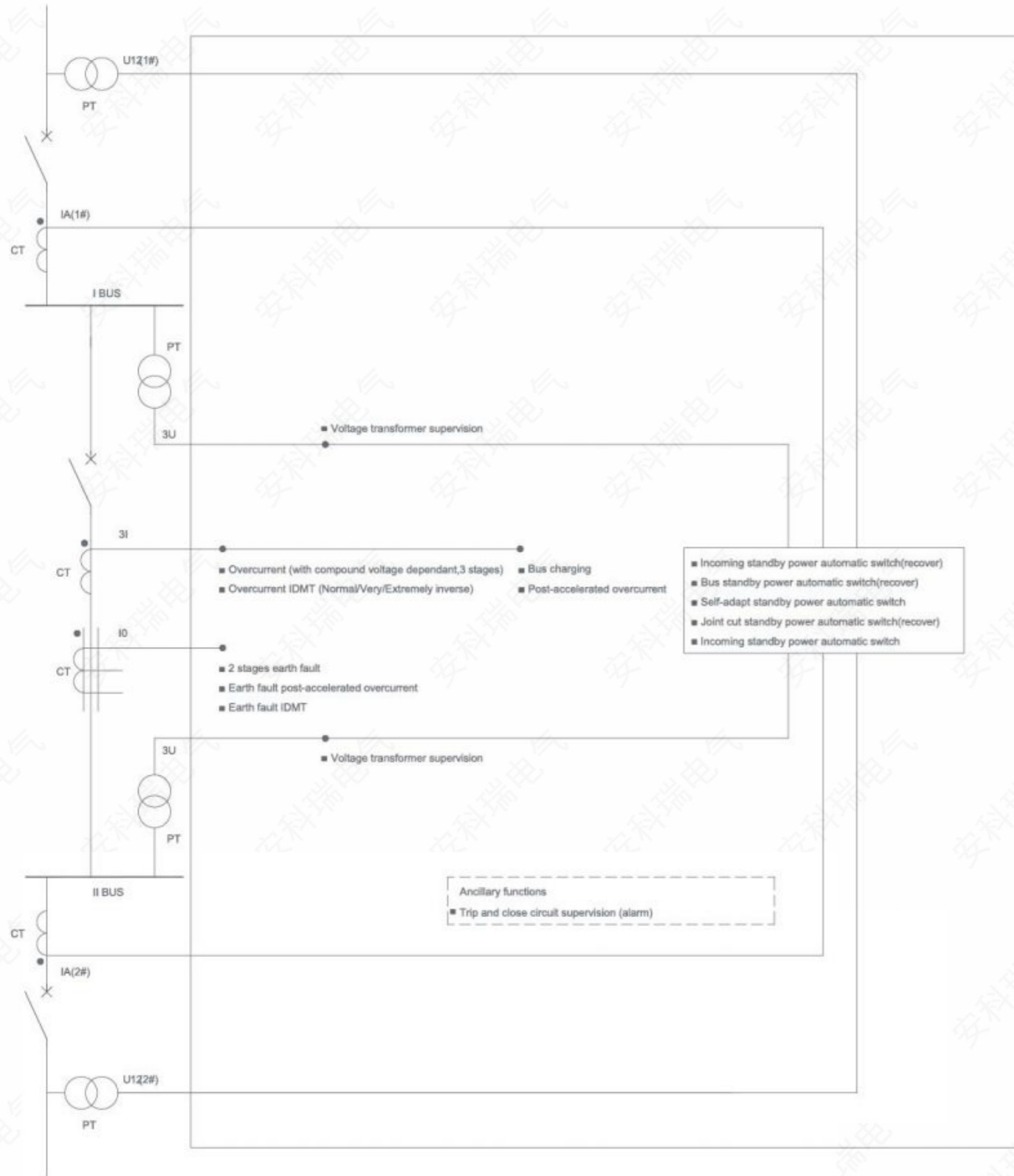

③ Wiring diagram

AM5-F:

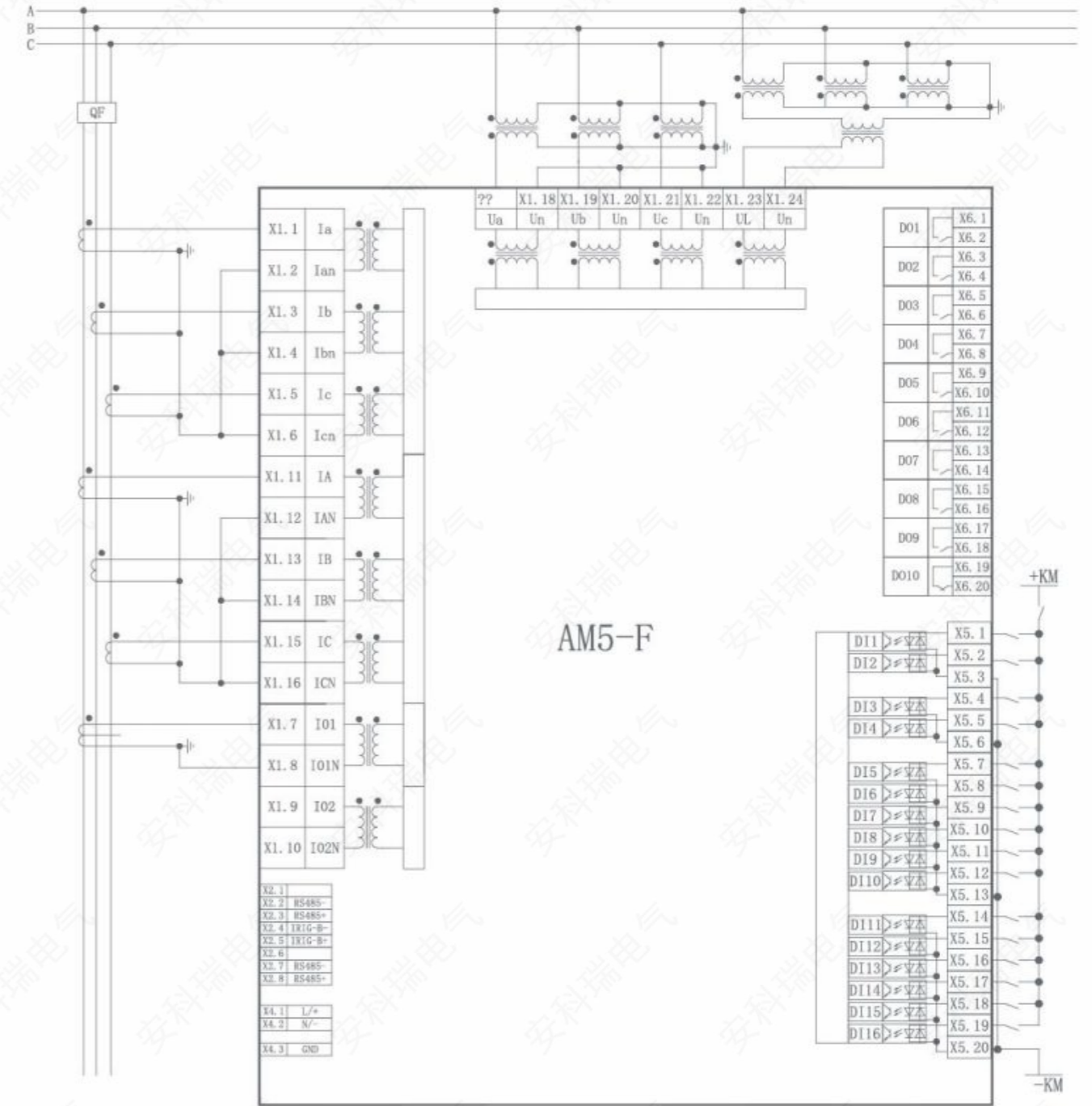

AM5-M:

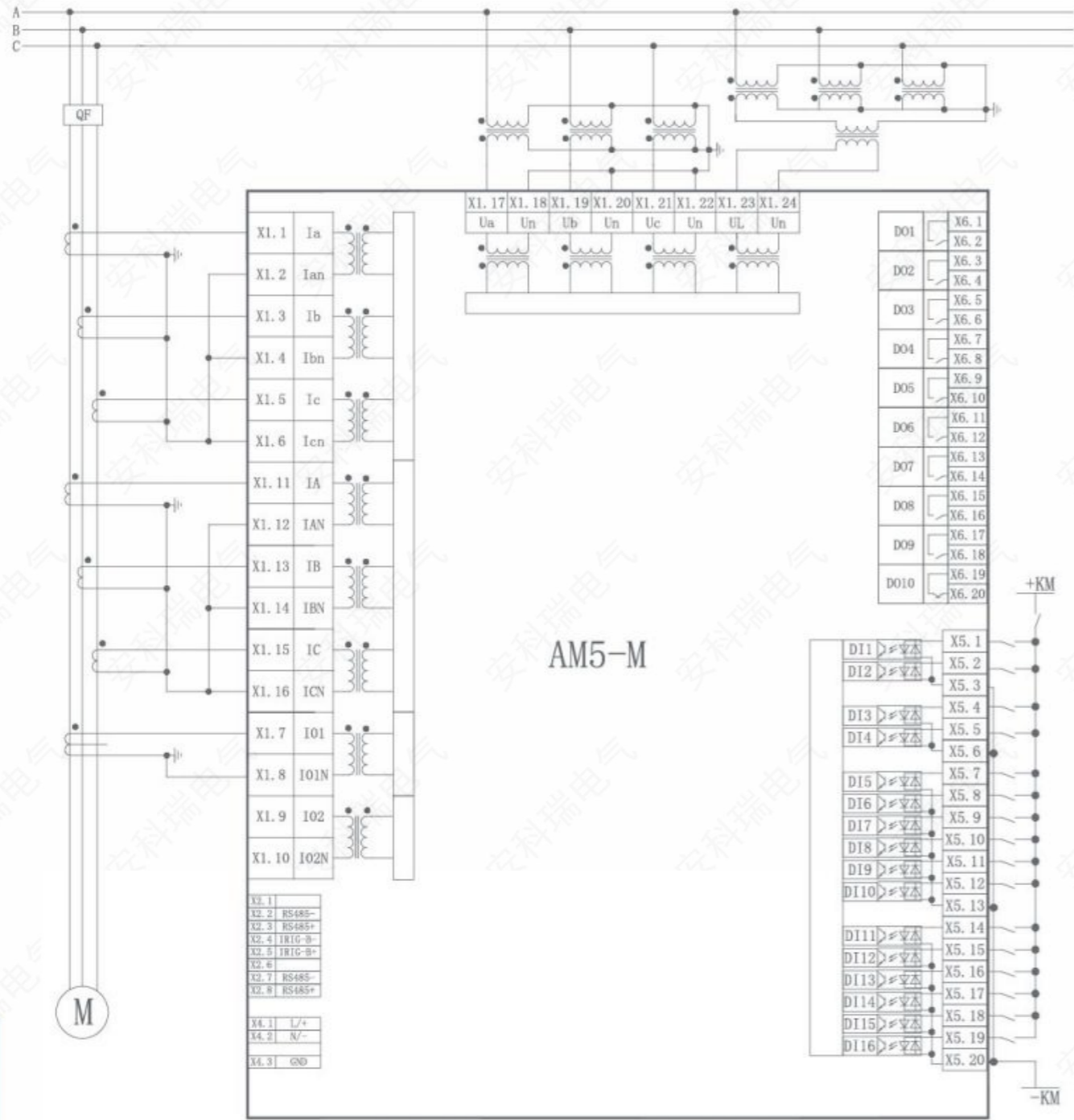

AM5-C:

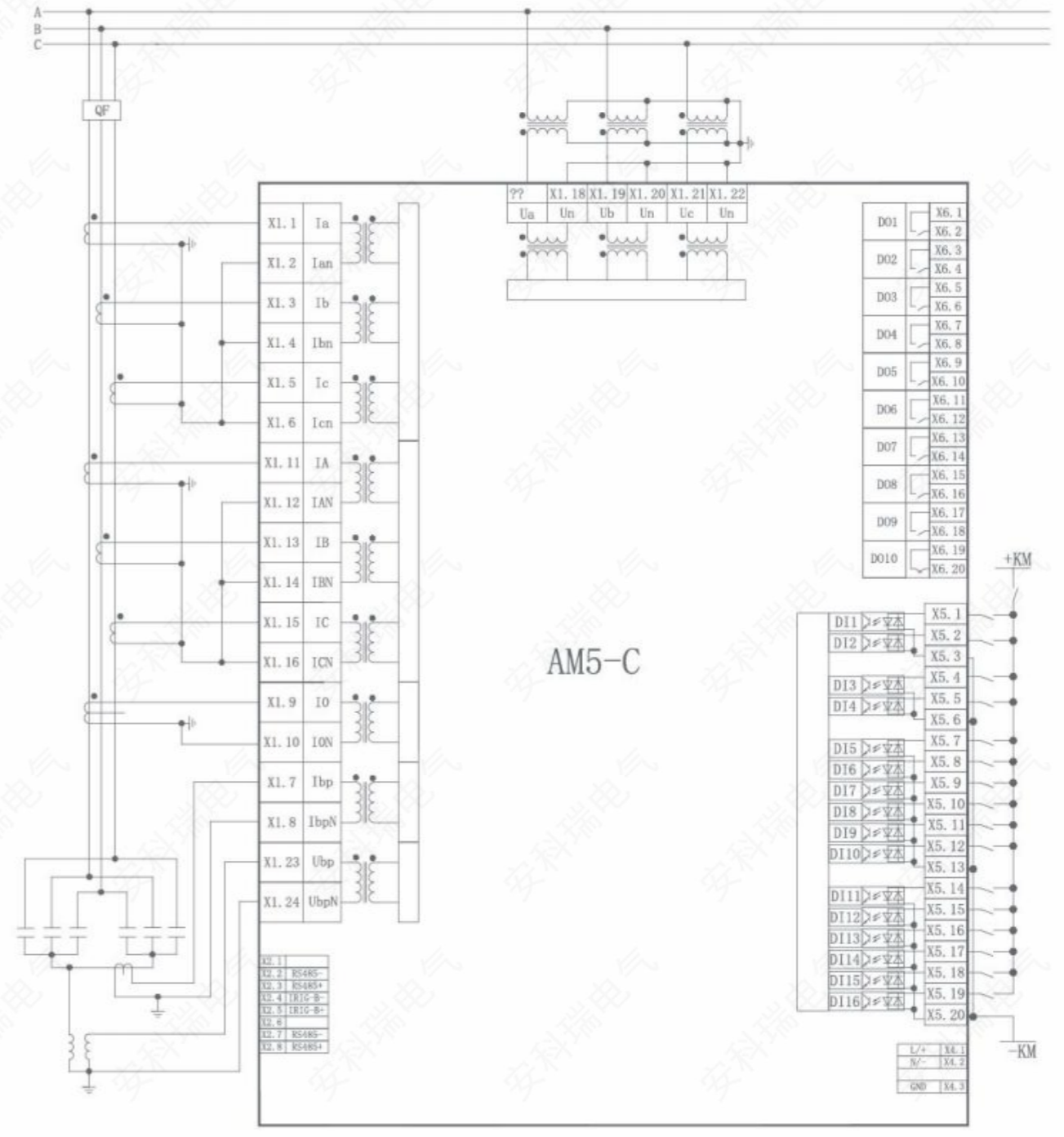

AM5-T:

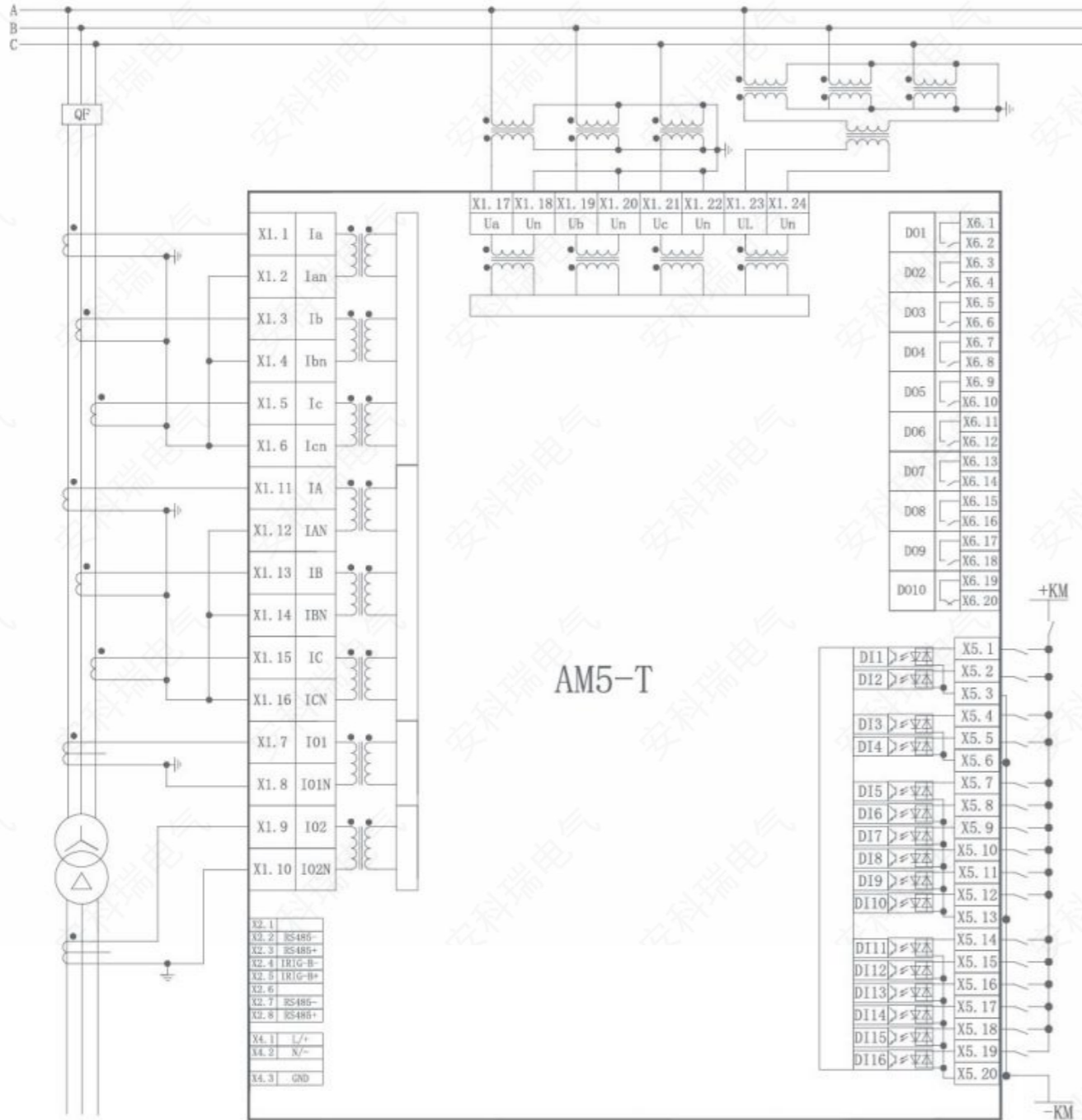

AM5-T

AM5-U1:

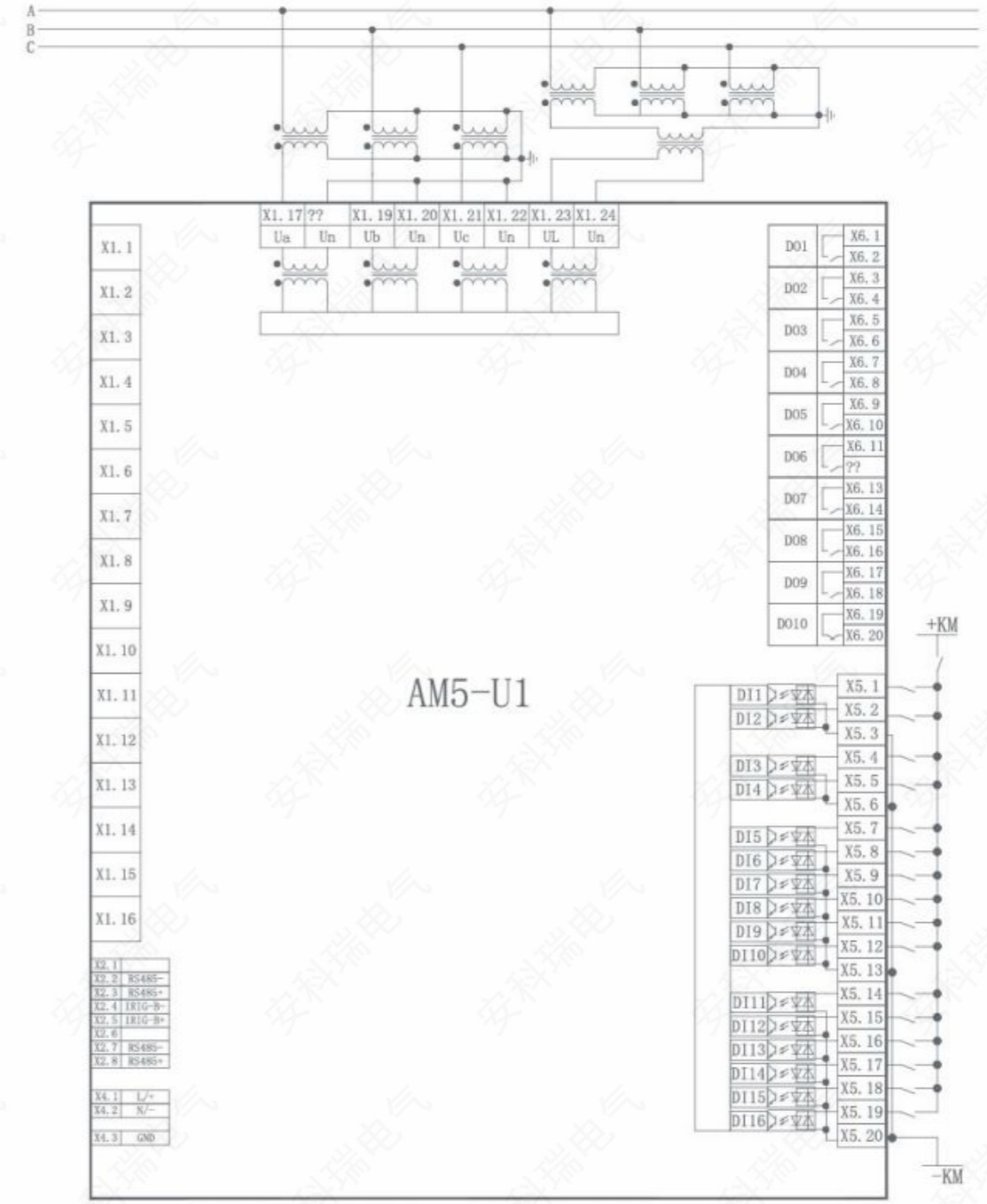

AM5-U1

AM5-DB:

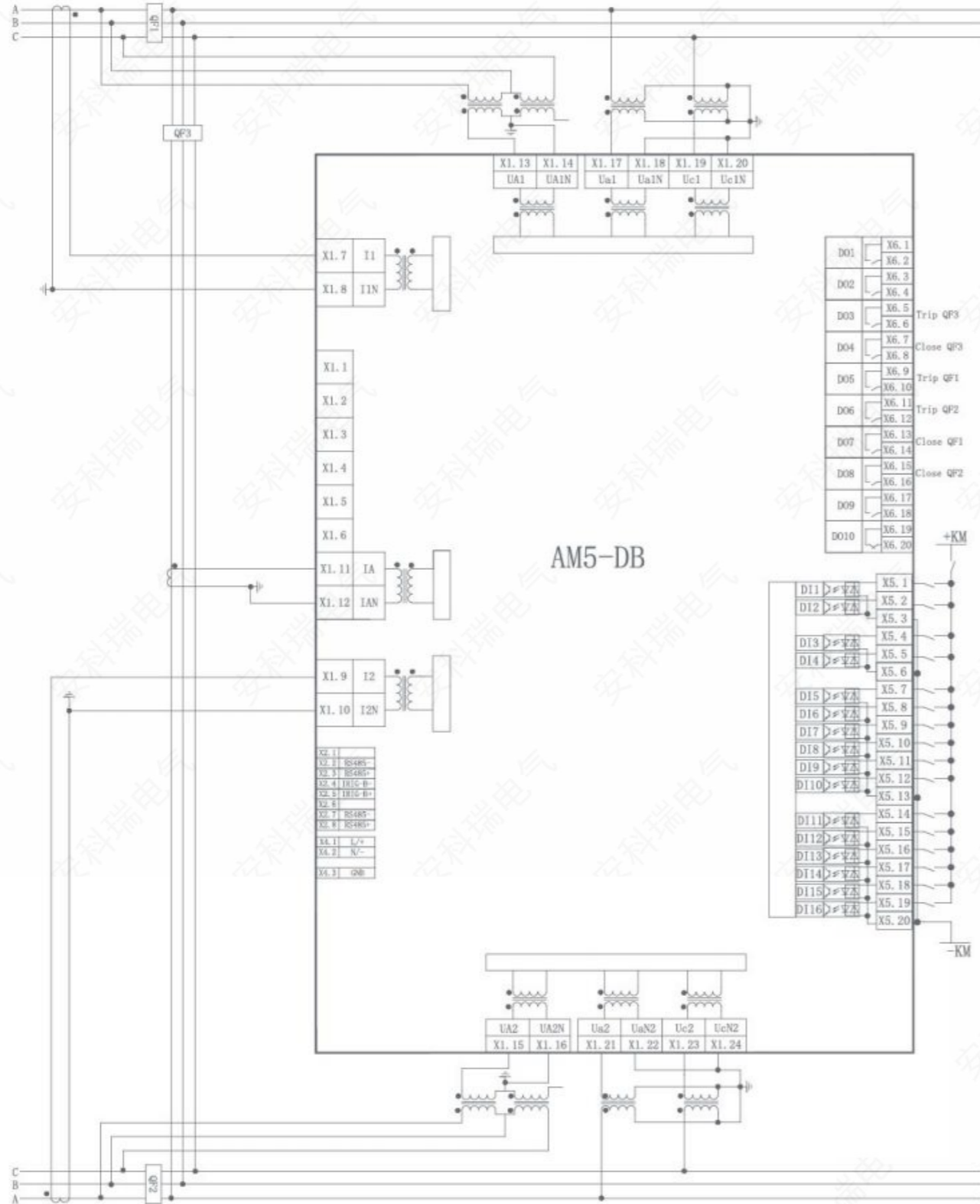

AM5-B:

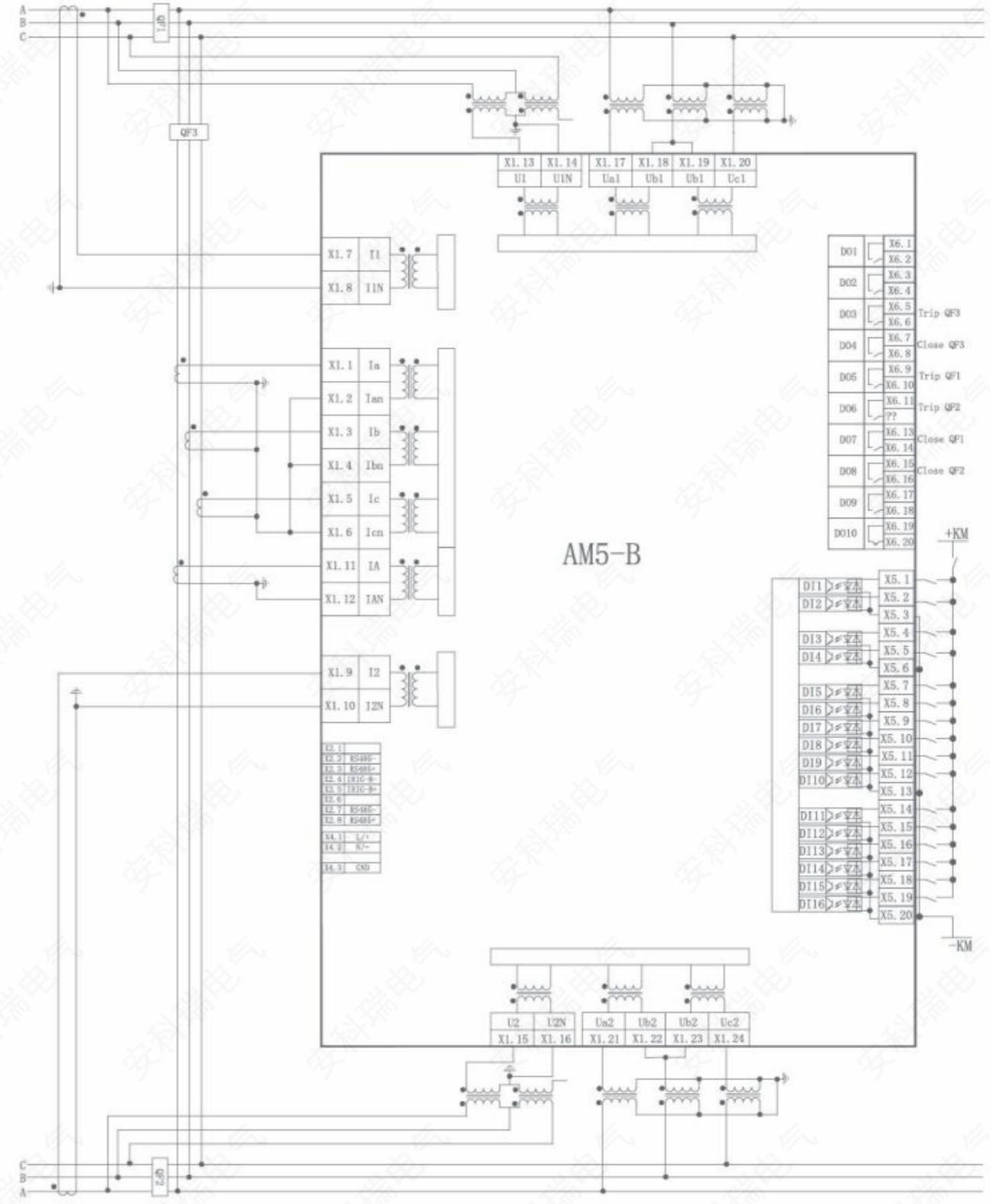

6.3 AM4 Series Protection Relay

Model Description

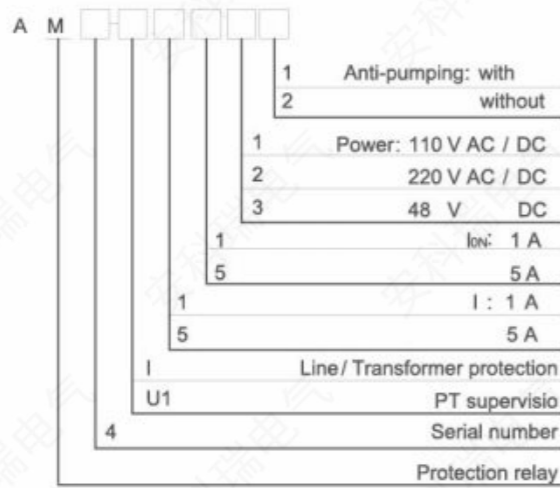

Functions

Protection Functions	AM4-	
	I	U1
Overcurrent (3 stages, IDMT)	■	
Earth fault (2 stages, IDMT)	■	
Negative sequence overcurrent (2 stages, IDMT)	■	
Auto-reclose	■	
Overload (trip/alarm)	■	
Under frequency	■	
Post-accelerated overcurrent	■	
Overvoltage (trip)	■	
Undervoltage (trip)	■	
FC block	■	
Trip and close circuit supervision (alarm)	■	
Non-electricity (trip/alarm)	■	
Undervoltage (alarm)	■	■
Overvoltage (alarm)	■	■
Residual overvoltage (alarm)	■	■
PT supervision (alarm)	■	■
Self-produced over zero-voltage (alarm)		■
Rear Ports	I	U1
RS485		■

Protection Functions	AM4-	
	I	U1
Protocols	I	U1
Modbus serial		■
IEC 60870-5-103		■
Measurement	I	U1
Electric parameter	U, I, P, Q, PF, F, Ep, Eq, Es	
Input current	4	0
Input voltage	4	4
Logs and Records	I	U1
Fault recorder		■
Sequence of event record		■
Monitoring Functions	I	U1
Anti-pumping circuit	Optional	
Remote control		■

Note: ■ standard □ optional

Wiring

① Functional wiring diagram

AM4-U1:



AM4-I:

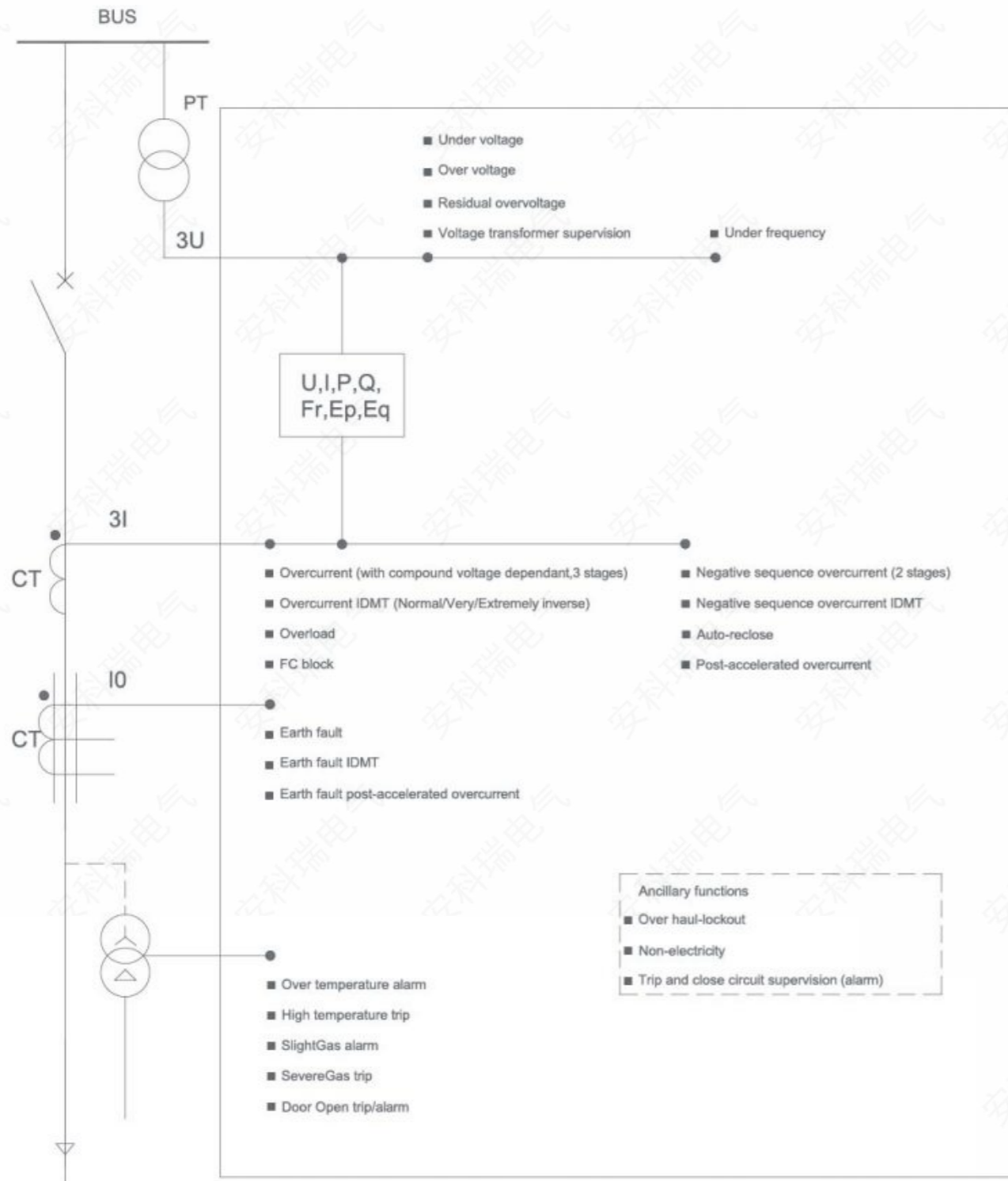

② Wiring diagram

AM4-U1:

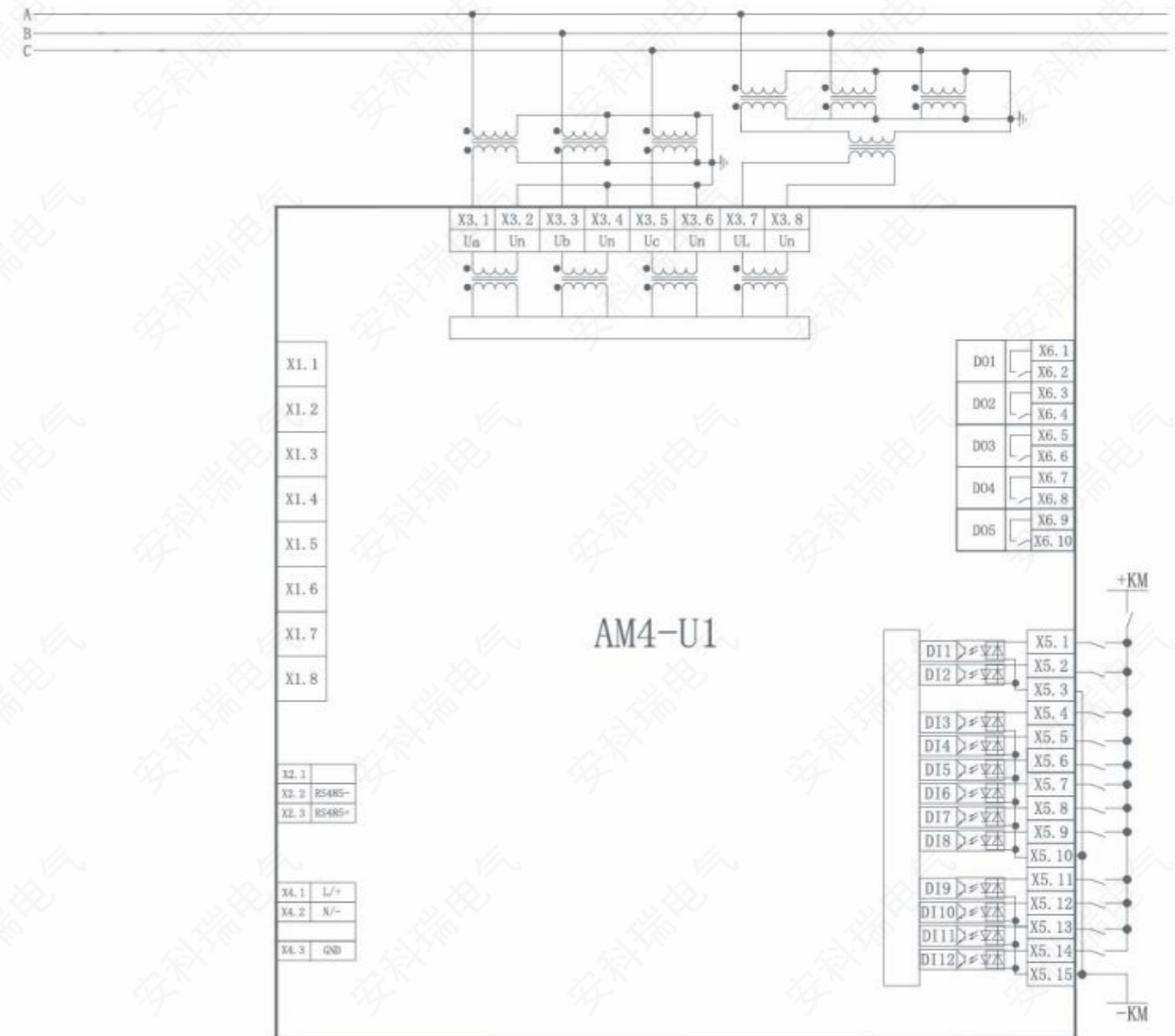

AM4-I:

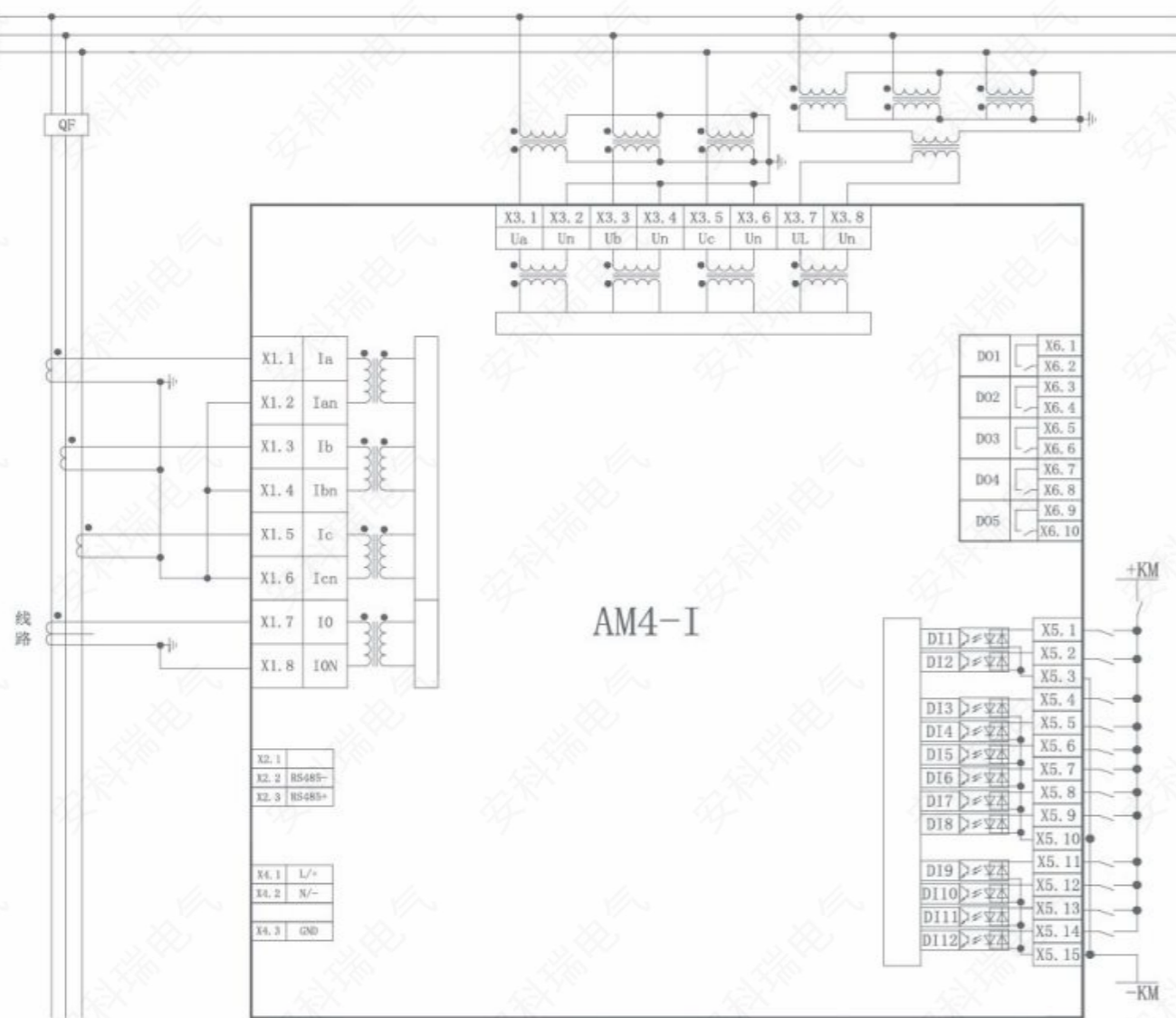

► 6.4 AM3SE Series Protection Relay

• Model Description

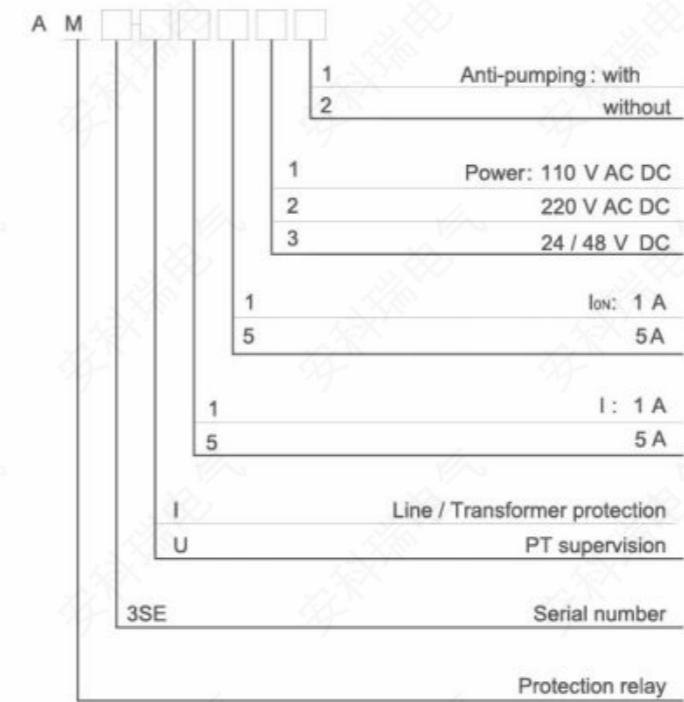

• Functions

Protection Functions	AM3SE-	
	I	U
Overcurrent (3 stages, IDMT)	■	
Earth fault (3 stages, IDMT)(I01/I02)	■	
Negative sequence overcurrent (2 stages, IDMT)	■	
Auto-reclose	■	
Overload (trip/alarm)	■	
Under frequency	■	
Post-accelerated overcurrent	■	
Post-accelerated overcurrent(I01/I02)	■	
Overvoltage(trip)	■	
Undervoltage (trip)	■	
Self-produced over zero-voltage (trip)	■	
Residual overvoltage (trip)	■	
FC block	■	
Trip and close circuit supervision (alarm)	■	
Non-electricity (trip/alarm)	■	
Undervoltage (alarm)	■	■

Protection Functions	AM3SE-	
	I	U1
Undervoltage (alarm)	■	■
Overvoltage (alarm)	■	■
Residual overvoltage (alarm)	■	■
PT supervision (alarm)	■	■
Self-produced over zero-voltage (alarm)		■
Rear ports	I	U
RS485		■
Protocols	I	U
Modbus serial		■
IEC 60870-5-103		■
Measurement	I	U
Electric parameter	U,I,P,Q,PF,Fr,Ep,Eq,Es	
Input Current	5	0
Input Voltage	3	3
Logs and Records	I	U
Fault recorder		■
Sequence of event record		■
Monitoring Functions	I	U1
Anti-pumping circuit	Optional	
Remote control		■

AM3SE-I:

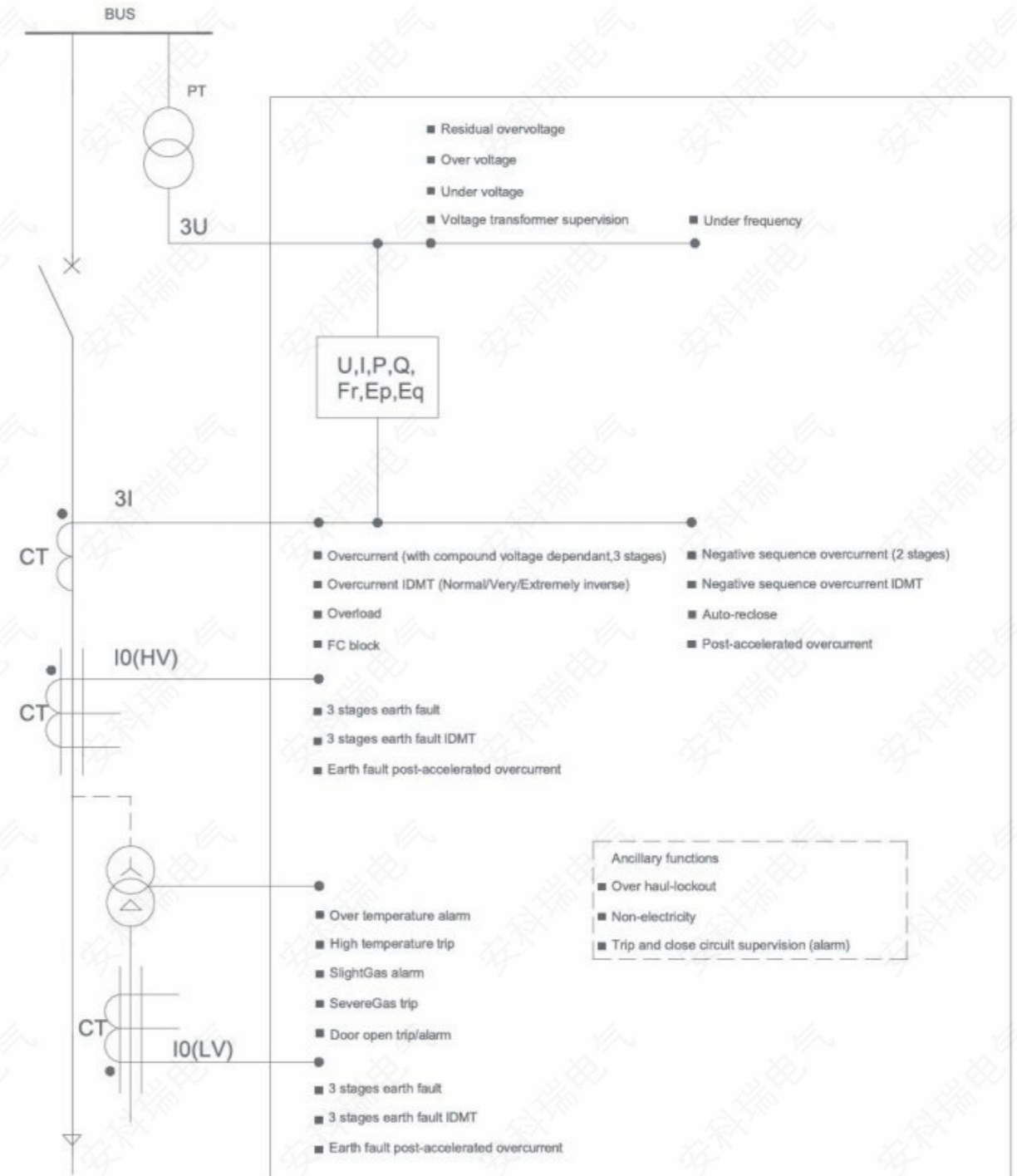

• Wirng

① Functional wiring diagram

AM3SE-U:

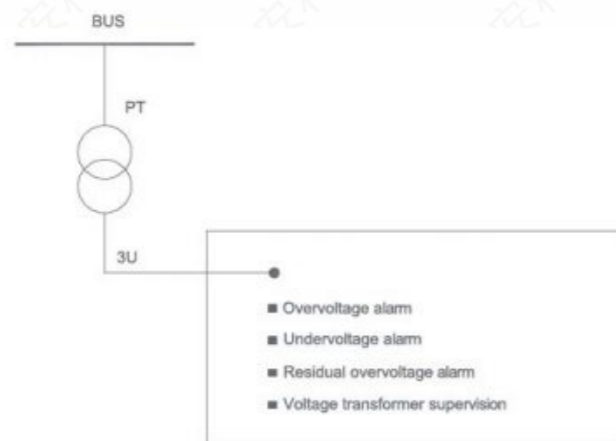

② Wiring diagram

AM3SE-U:

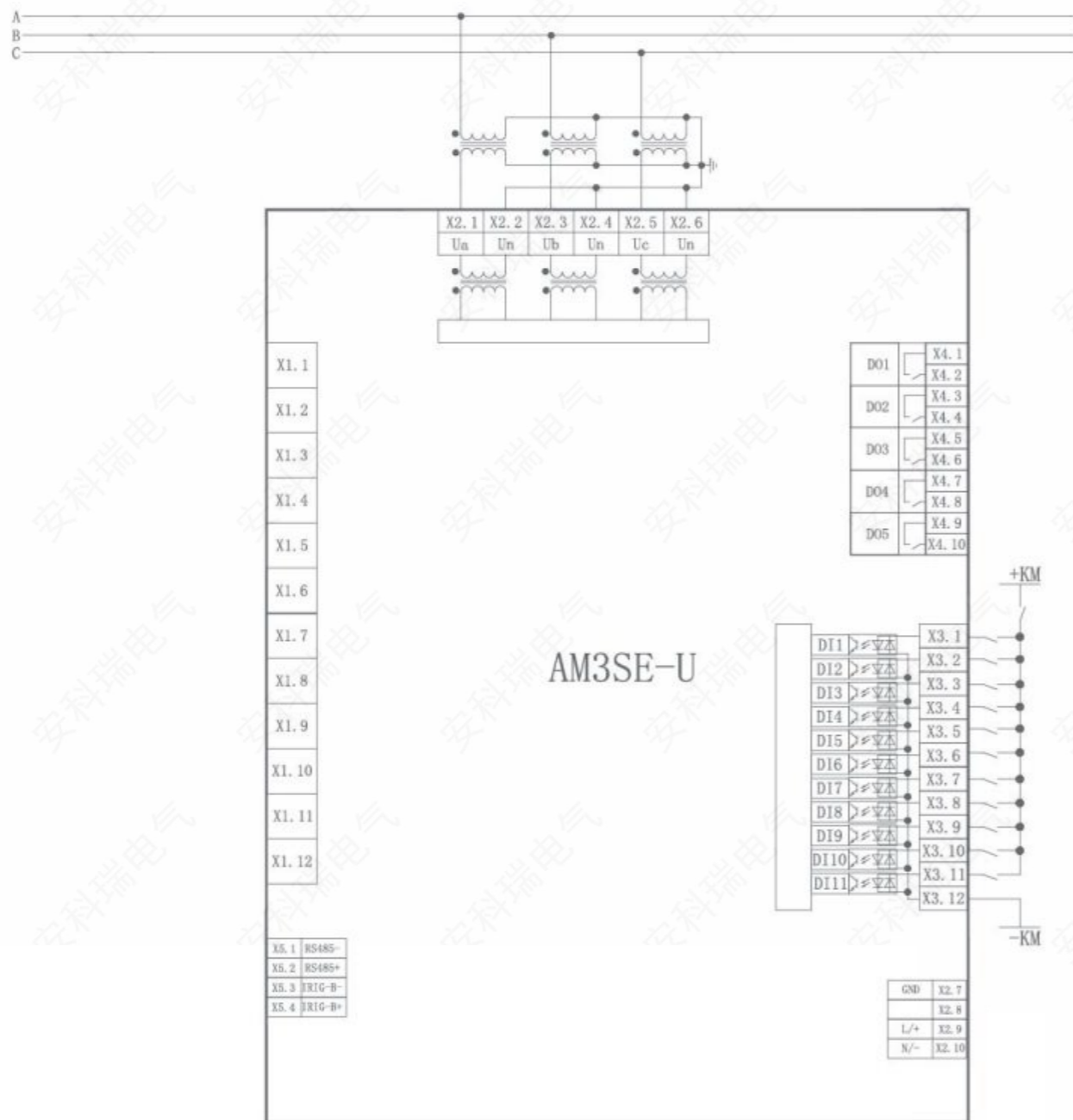

AM3SE-I:

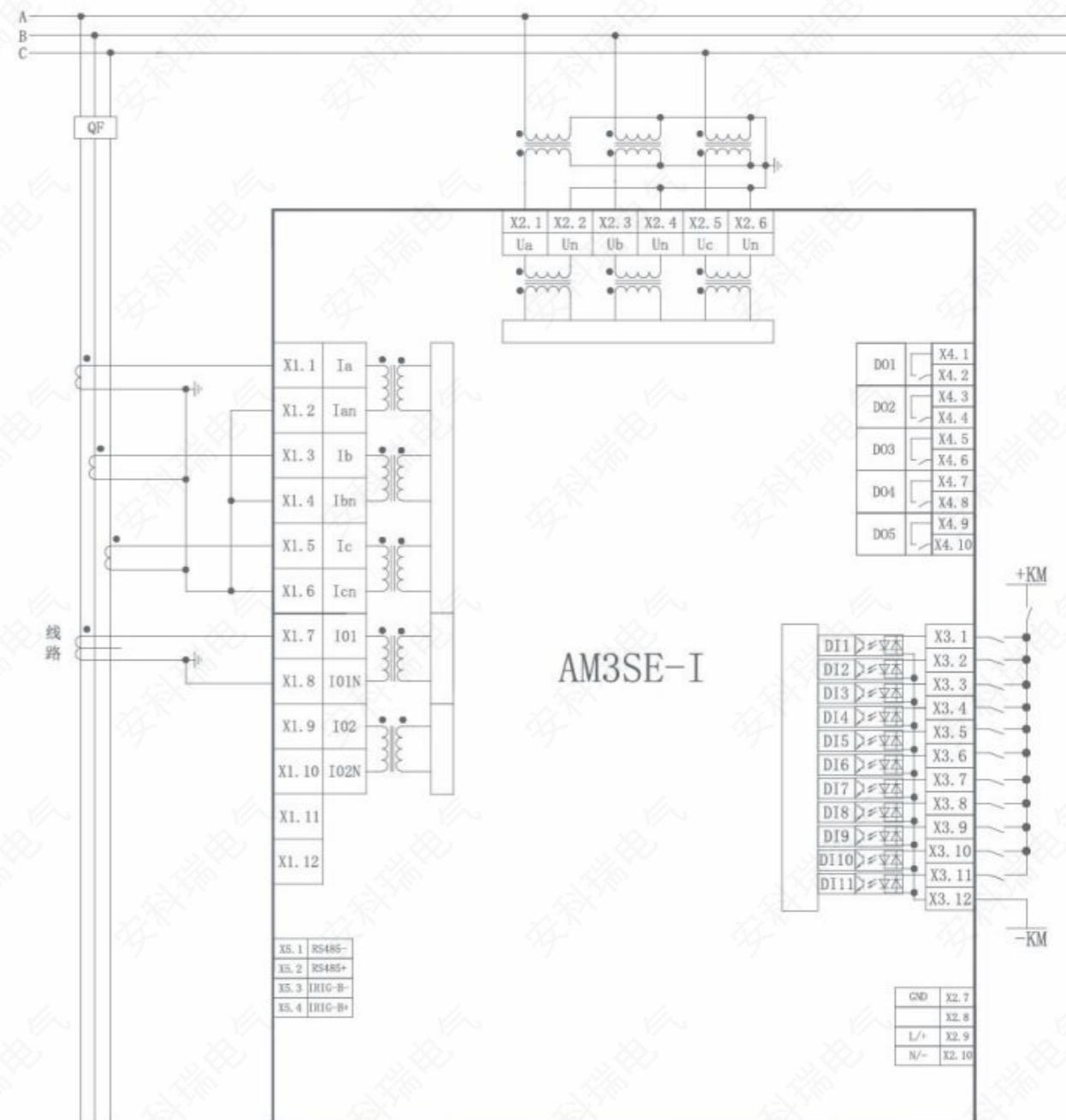

▶ 6.5 AM2SE Series Protection Relay

• Model Description

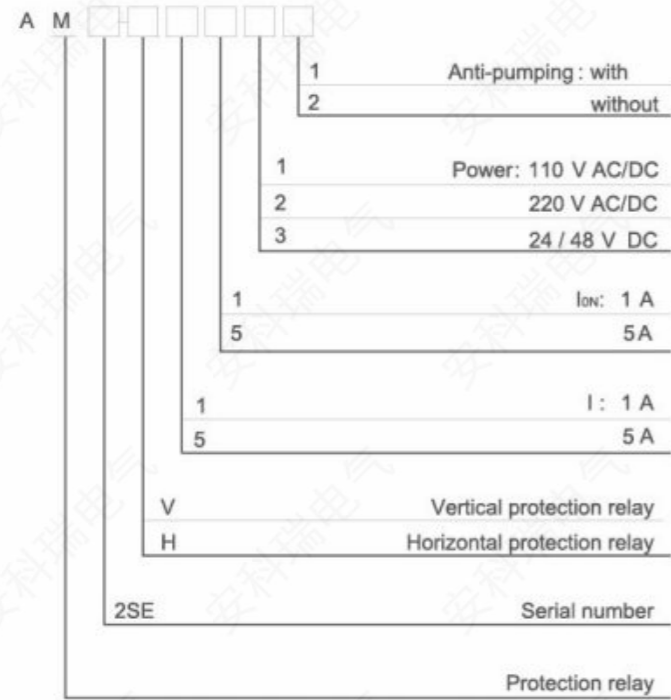

• Functions

Protection Functions	AM2SE-	
	V	H
Overcurrent (3 stages,IDMT)	■	
Earth fault (3 stages,IDMT)	■	
Negative sequence overcurrent (2 stages,IDMT)	■	
Auto-reclose	■	
Overload (trip/alarm)	■	
Under frequency	■	
Post-accelerated overcurrent	■	
I0 Post-accelerated overcurrent	■	
Overvoltage(trip)	■	
Undervoltage (trip)	■	
Self-produced over zero-voltage (trip)	■	
Residual overvoltage (trip)	■	
FC block	■	
Trip and close circuit supervision (alarm)	■	
Non-electricity (trip/alarm)	■	

Protection Functions	AM2SE-	
	V	H
Undervoltage (alarm)		■
Overvoltage (alarm)		■
Residual overvoltage (alarm)		■
PT supervision (alarm)		■
Self-produced over zero-voltage (alarm)		■
Rear ports	V	H
RS485		■
Protocols	V	H
Modbus serial		■
IEC 60870-5-103		■
Measurement	V	H
Electric parameter		U,I,P,Q,PF,Fr,Ep,Eq,Es
Input Current		4
Input Voltage		3
Logs and Records	V	H
Fault recorder		■
Sequence of event record		■
Monitoring Functions	V	H
Anti-pumping circuit		Optional
Remote control		■

• Wiring

① Functional wiring diagram

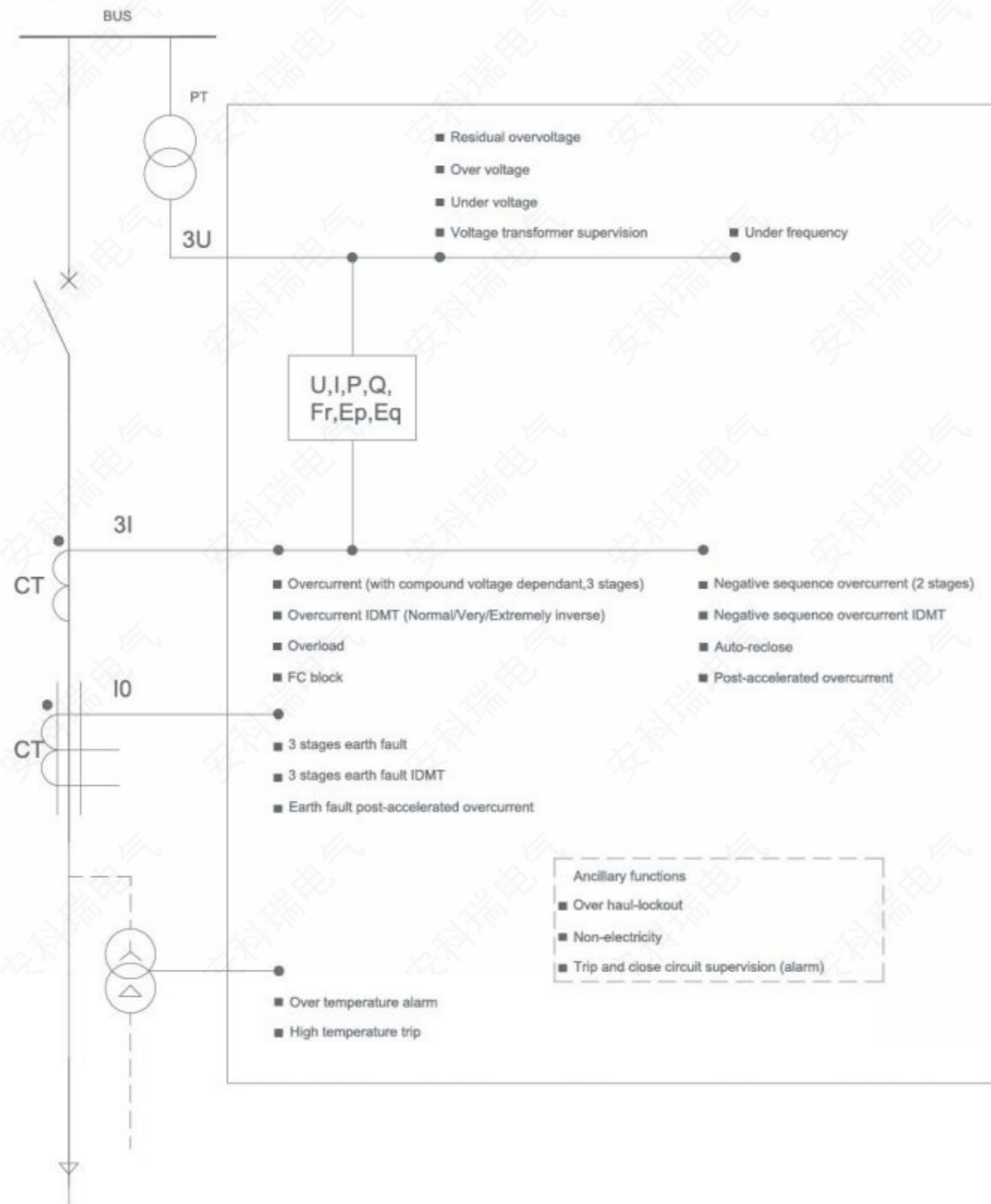

② wiring diagram

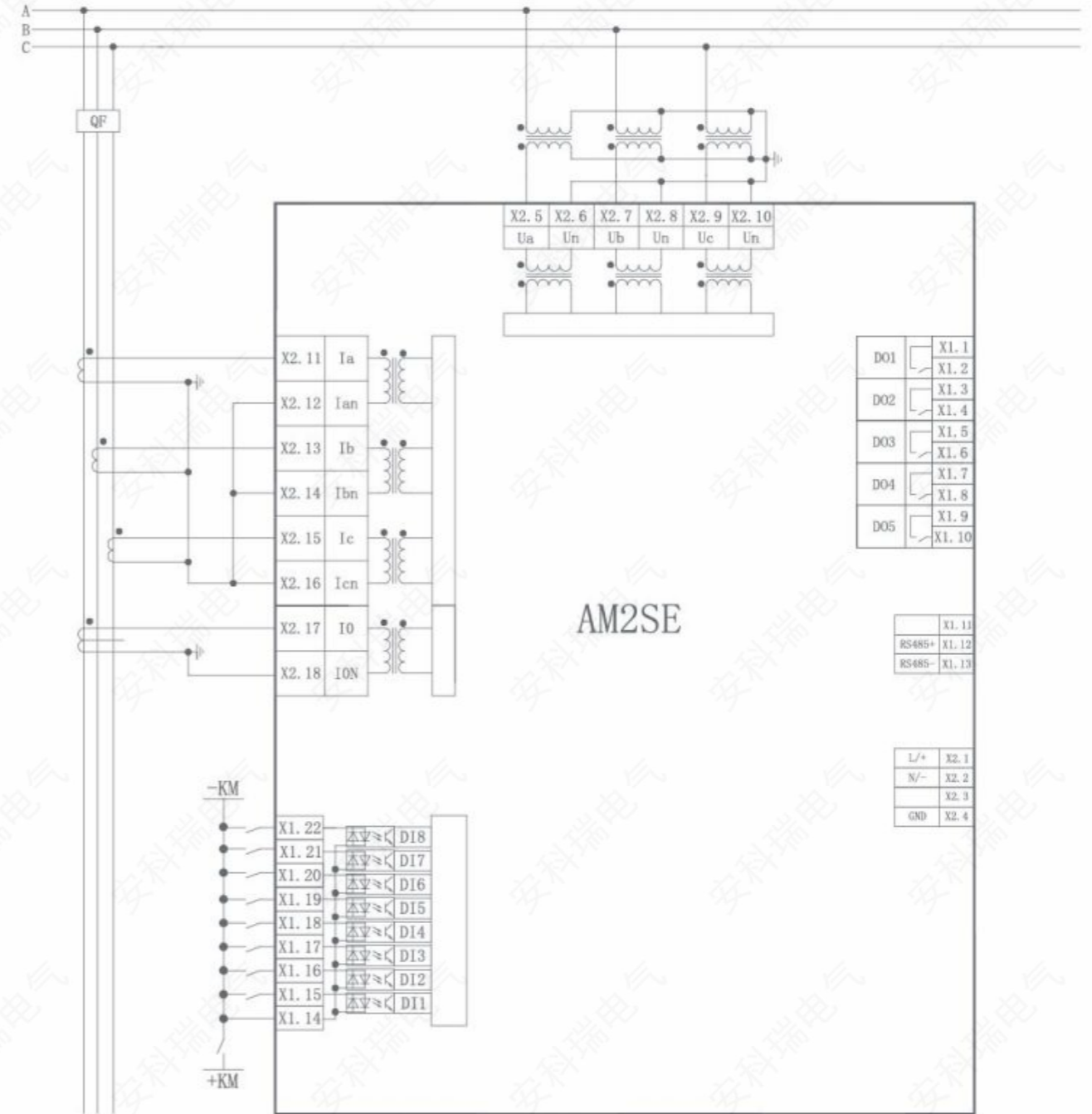

7.ARTM Series Temperature Monitor

7.1 ATE

Model Description

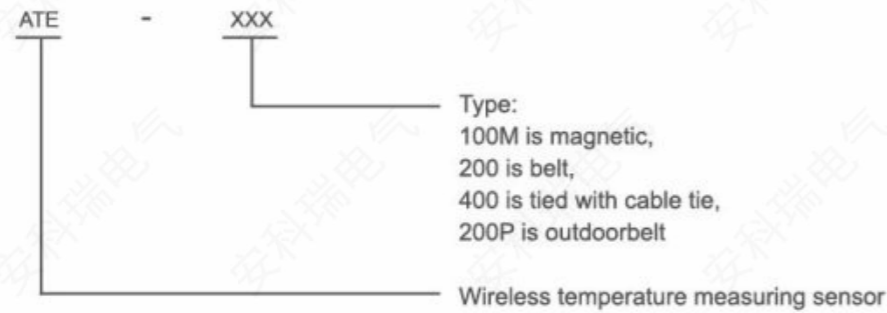

Technical Parameter

Items	Features	
Environment	Temperature	-40℃~85℃
	Humidity	≤95%
	atmospheric pressure	86kPa~106kPa
ATE100M/200 active wireless temperature sensor	Wireless frequency	470MHz,433MHz
	Communication distance	150m in open area(470MHz) 50m in open area(433MHz)
	Sampling frequency	25s
	Transmitting frequency	25s-5min
	Power source	Battery
	Installation	Magnetic/Belt
	Range of temperature	-50℃~+125℃
	Precision	±1℃
	Application	Joints in high or low voltage switchgears
	Battery life	≥5 years (25℃)
400 passive wireless temperature sensor	Wireless frequency	470MHz,433MHz
	Communication distance	150m in open area(470MHz) 50m in open area(433MHz)
	Sampling frequency	15s
	Transmission frequency	15s
	Power source	CT-powered, starting current≥5A
	Installation	alloy chip fixing
	Sensor probe	alloy bottom
	Range of temperature	-50℃~125℃
	Precision	±1℃
Application	Joints in high or low voltage switchgears	

Items	Features	
ATE200P outdoor wireless temperature sensor	Wireless frequency	470MHz,433MHz
	Communication distance	150m in open area(470MHz) 50m in open area(433MHz)
	Sampling frequency	25s
	Transmitting frequency	25s-5min
	Power source	Battery
	Installation	Belt
	Range of temperature	-50℃~+150℃
	Precision	±0.5℃
	Application	outdoor cable joint
	Battery life	≥5 years (25℃)
Protection level	IP68	

7.2 ATC

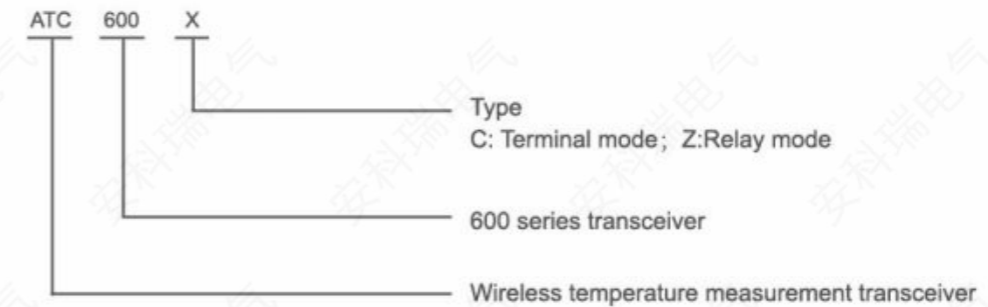

Model Description



Technical Parameter

Items	Features	
Transceiver ATC600	Power source	AC/DC100~265V、DC12~48V ≤6VA
	Power Consumption	≤2W
	points	No more than 240 points
	Resolution	0.1℃
	Range of temperature	-50℃~+125℃
	Precision	±1℃
	Wireless frequency	470Mhz/433Mhz
	Wireless distance	Receiver sensor 150m (470Mhz in open area),
		or 50m (433Mhz in open area),
		Relay distance 1Km (in open area)
	Communication	RS485

Items	Features	
Transceiver ATC600	Protocol	MODBUS-RTU
	Baud rate (bps)	2400, 4800, 9600, 19200
	Relayoutput	2 passive output, capacity 5A/AC250V, 5A/DC30V
	Environment	Temperature:-20 ℃~+55 ℃; Humidity:≤95%

Shape	Type	Parameter	Application
	ATC600-C Terminal mode	Power supply: AC/DC 85~265V or 12~48V Installation:35mm din rail installed Communication: 1 channel RS485-Modbus RTU Alarm:2 channel DO	Receive 240 sensors ATE100M/ATE200/ ATE400/ATE200P
	ATC600-Z Relay mode	Power supply: AC/DC 85~265V or 12~48V Installation:35mm din rail installed	Pass-through as a relay module use with ATC600-C

7.3 ARTM-8,ARTM-24

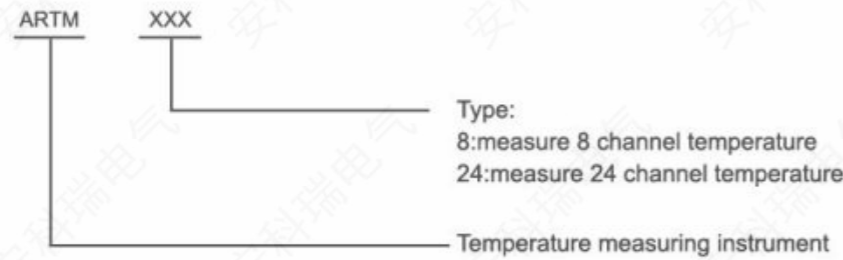

Model Description



Technical Parameter

Items	Features	
Type	ARTM-8 ARTM-24	
Channels	8 24	
Inputs	Thermal resistance: Pt100 NTC: R25=50.00kΩ±1%; B25/50=4150K±1%; PT100: Three-wire system Thermocouple:K, T, J, E	
Accuracy	0.5S ±1%	
Power supply	Voltage	AC85~265V, DC 100~350V
	Consumption	≤2W

Items	Features	
Alarm	Channels	2 groups normally open
	Capacity	AC250V/5A, DC30V/5A
Temperature and humidity input (Optional function)	Channels	— 1
	Ambient temperature	— ±1 ℃
	Environment humidity	— ±3%RH
Communication	Protocol	MODBUS-RTU
	Interface	RS485
	Baud rate	1200, 2400, 4800, 9600, 19200
Powerfrequency withstand voltage		2kV/1min AC effective value
Environment	Temperature	Working: -20~+55 ℃, Storage: -25~+70 ℃
	Humidity	≤95%, No dew, no corrosive gas place
	Altitude	≤2500m

Shape	Type	Features
	ARTM-8	Panel mounted Cutout:88*88mm 8 channel Pt100 temperature measurement 2 channel alarm output 1 channel RS485-Modbus RTU
	ARTM-24	35mm Din rail installed 24 channel NTC themocouple or Pt100 temperature measurement 1 channel temperature and humidity measurement 2 channel alarm output 1 channel RS485-Modbus RTU

Wiring

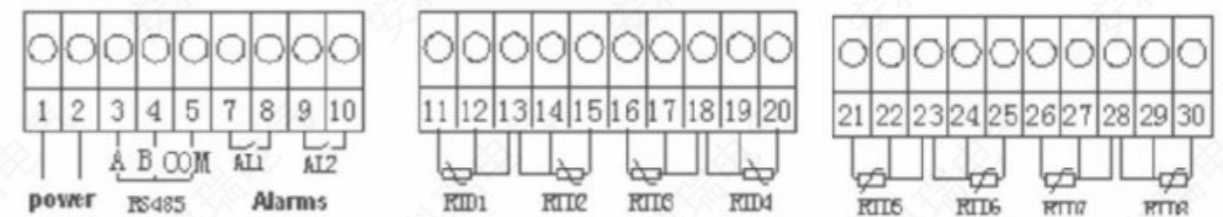

ARTM-8 PT100 wiring diagram

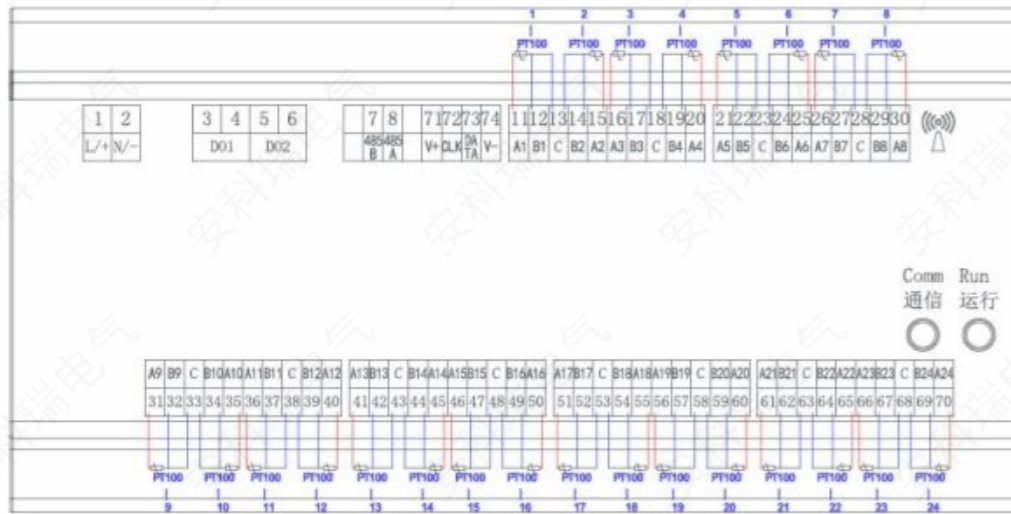

ARTM-24 PT100 wiring diagram

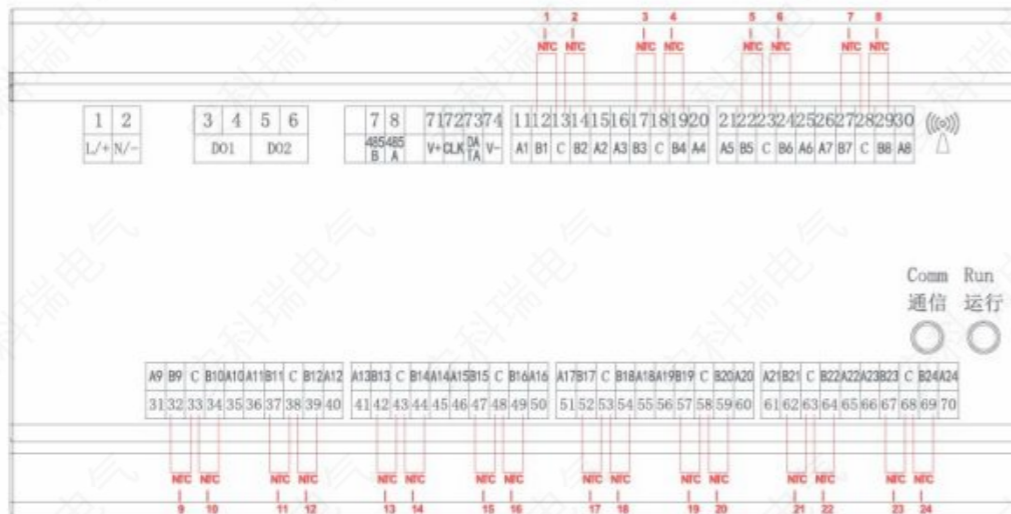

ARTM-24 NTC wiring diagram



Thermocouple wiring diagram

8.ASJ Series Power Relay

8.1 ASJ Series Residual Current Relay

Model Description



Shape	Panel size (mm)	Cut-out (mm)
20	48*48	45*45
10	DIN 35mm	
10L		





Technical Parameter

Technical parameter	Value		
	AC type	A type	
Input	Rated residual operated current $I_{\Delta n}$	0.03,0.1,0.3,0.5(A)	0.03,0.05,0.1,0.3,0.5,1,3,5,10,30(A) ^{note1}
	Limited non-actuating time	0.1,0.5(S)	0.0,0.6,0.1,0.2,0.3,0.5,0.8,1,4,10(S) ^{note2}
	Rated residual non-operating current I_{Δ}	50% $I_{\Delta n}$	Adjustable
	Features	Sinusoidal AC current	Sinusoidal AC current and pulsating DC current
Frequency	50Hz±5Hz		
Tripping accuracy	-20%~-10% $I_{\Delta n}$		
Output	Output mode	1 NC contact, 1 normal changeover contact	1 NC contact, 1 normal changeover contact, all adjustable
	Contact capacity	5A/250VAC,5A/30VDC	AL1:8A/250VAC,5A/30VDC;AL2:6A/250VAC,5A/30VDC
	Reset mode	Local,remote	Local,remote,automatic
Auxiliary power supply	Voltage range	AC110V,AC220V(±10%)	AC/DC85~270V
	Power consumption	≤5W	
Power frequency withstand voltage	The effective value of alternating current between the power supply, input and output: 2kV/1min		
Environment	Temperature	Operation:-20℃~+55℃,Storage:-30℃~+70℃	
	Humidity	≤95%RH(No condensation)	
	Altitude	≤2000m	

Note1: For ASJ10L-LD1A, the $I_{\Delta n}$ is continuously adjustable from 10mA to 30A.

Note2: For ASJ10L-LD1A, the Δt is continuously adjustable from 0s to 10s.

• Product Functions

Shape	Type	Function	Option&Price
	ASJ20-LD1C	Measurement of type AC residual current Alarm when the residual current exceeds the set value Adjustable rated residual current from 0.03 to 0.5 A Adjustable limiting no-actuating time from 0.1s to 0.5s 2 relay output(1 NC contact,1 normal changeover contact) Local/ remote "test" and "reset" function	/
	ASJ20-LD1A	Measurement of type A residual current Residual current percentage light bar indication (30%,50%,70%,TRIP) Adjustable rated residual current from 0.03 to 30 A Adjustable limiting no-actuating time from 0.1 to 10s 2 programmable relay output(1 NC contact,1 normal changeover contact) Local/ remote/automatic "test" and "reset" function	/
	ASJ10-LD1C	Measurement of type AC residual current Alarm when the residual current exceeds the set value Adjustable rated residual current from 0.03 to 0.5 A Adjustable limiting no-actuating time from 0.1s to 0.5s 2 relay output(1 NC contact,1 normal changeover contact) Local/ remote "test" and "reset" function	/
	ASJ10-LD1A	Measurement of type A residual current Residual current percentage light bar indication (30%,50%,70%,TRIP) Adjustable rated residual current from 0.03 to 30 A Adjustable limiting no-actuating time from 0.1 to 10s 2 programmable relay output(1 NC contact,1 normal changeover contact).Local/ remote/automatic "test" and "reset" function	/
	ASJ10L-LD1A	Measurement of type A residual current Continuously adjustable of Rated residual current from 0.03 to 30 A Continuously Adjustment of limiting no-actuating time 0.1 to 10s 2 programmable relay output(1 NC contact,1 normal changeover contact) Local/ remote/automatic "test" and "reset" function Multi-function LC display RS485 communication with modbus-RTU protocol	/C:RS485

• Wiring

◆ Auxiliary Power Supply and Signal Input

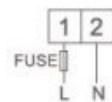

Auxiliary power supply

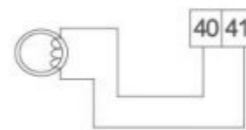

Signal input

◆ ASJ10L-LD1A communication terminals

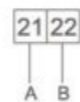

RS485

◆ Relay Output

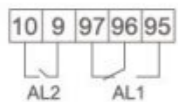

Relay output terminal
AL1:alarm
AL2:warning

◆ Additional Functions

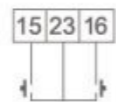

Remote test Remote reset

• Selection of residual current transformer

Type	Rated current	Ratio	Accuracy	Hole size (mm)
L-35	16~100A	5A/5mA	0.5	35
L-70	100~250A	5A/5mA	0.5	70
L-105	250~400A	5A/5mA	0.5	105
L-45	16~100A	5A/5mA	1	45
L-80	100~250A	5A/5mA	1	80
L-100	250~400A	5A/5mA	1	100
L-150	400~800A	5A/5mA	1	150
L-200	800~1500A	5A/5mA	1	200
L-80X50II	16~100A	5A/5mA	0.5	82X52
L-100X50II	16~100A	5A/5mA	0.5	103X55
L-130X50II	100~200A	5A/5mA	0.5	135X55
L-150X130II	100~300A	5A/5mA	0.5	150X133
L-180II	100~200A	5A/5mA	0.5	182X35
L-200X50II	250~400A	5A/5mA	0.5	202X61
L-260X100II	450~800A	5A/5mA	0.5	265X104
L-17030	100~200A	5A/5mA	1	172X34
L-210 X160	450~800A	5A/5mA	0.5	210 X160

➤ 8.2 ASJ60-LD16A Residual Current Monitoring

• Technical Parameter

Technical parameter	Value
Power supply	Voltage range AC/DC85V~265V
Input	Maximum power consumption ≤10VA
	Max. measure channels 16 channels
	Residual current measurement range 1mA~30A
	Rated residual operating current I _{Δn} 1 mA ~30A Continuously adjustable
	Action characteristics AC sinusoidal alternating current and pulsating direct current
	Frequency 50Hz±5Hz
	Action delay 0-10s can be set
Output	Switch input 2 passive dry node inputs
	Output method 1 waterlog alarm relay (normally open) 16-channel residual current alarm relay (normally open)
Auto-reclosing brake	Capacity AC 250V/3A DC 30V/3A
	Times 0-99 can be set continuously
Communication	Intervals 0-999 seconds can be set continuously
	Method 1 RS485communication, Modbus-RTU protocol Method 2 (optional) 4G wireless communication

Technical parameter		Value
Environment	Temperature	Working temperature: -10℃~55℃, storage temperature: -30℃~70℃
	Humidity	≤95%, No condensation
	Altitude	≤2000m
	Mean time between failures	≥50000 hours

Shape	Type	Function
	ASJ60-LD16A	16 measuring channels per device for residual current measurement, response ranges: 1mA...30A. 17 relays with N/C or N/O contacts, 16 relays for per residual current measuring channel, one for waterlog. Fault trip and automatic reclosing for each channel, adjustable reclosing times and delay. 2 DI for waterlog and other switch status. Up to 30 fault message memory. Mute/test/reset function.

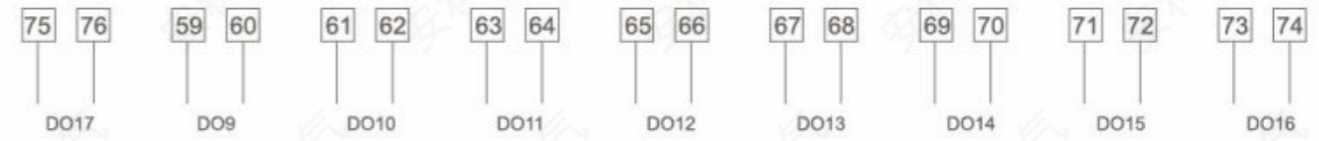
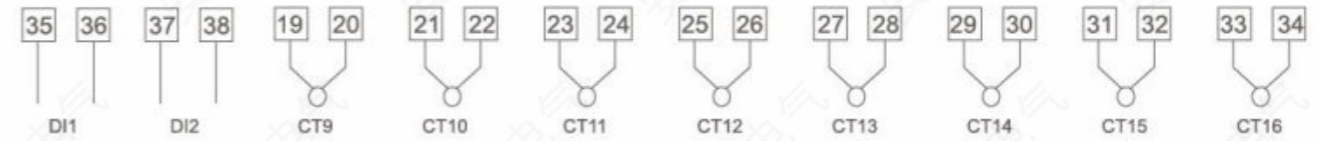
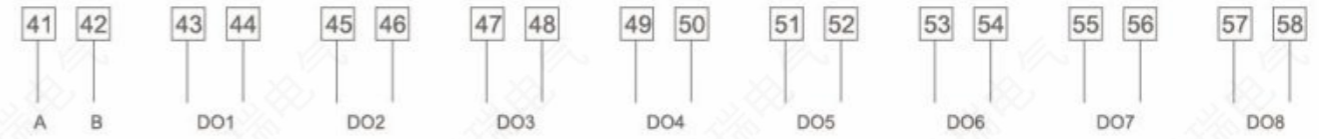
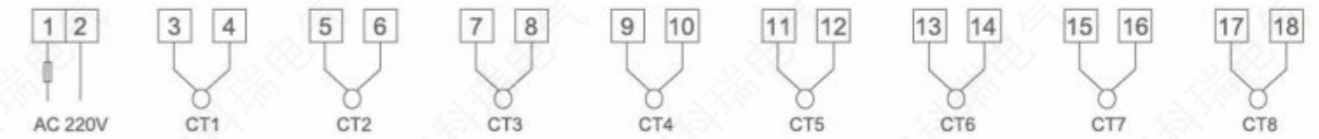

• Wiring

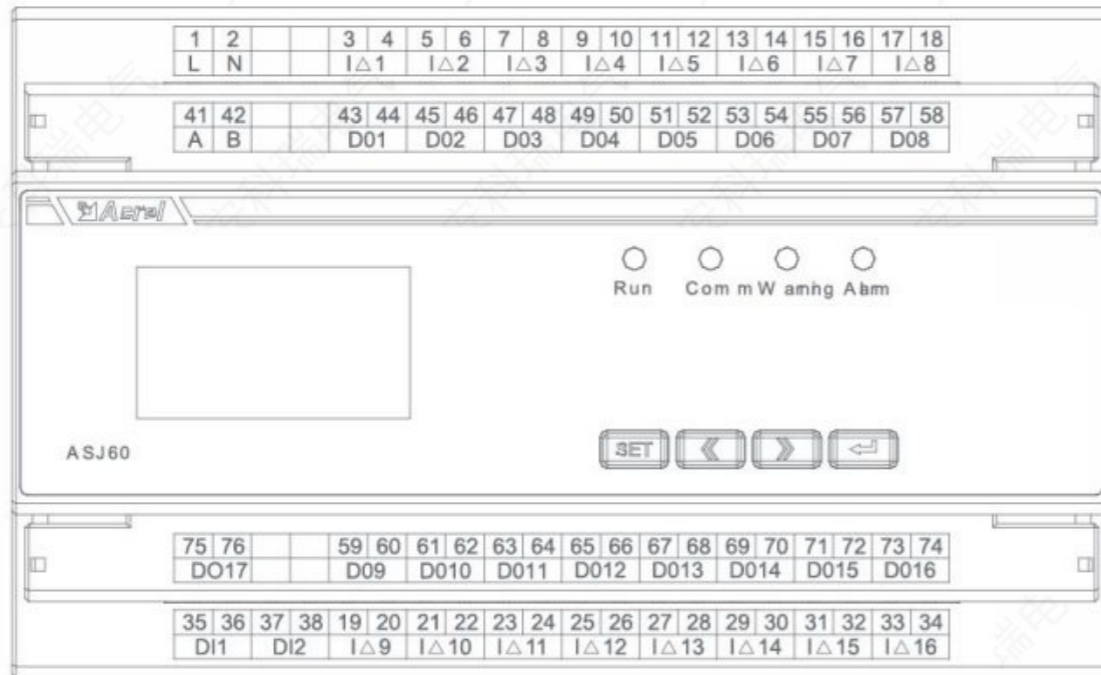

• Selection of residual current transformer

Type	Rated current	Ratio	Accuracy	Hole size (mm)
L-35	16-100A	5A/5mA	0.5	35
L-70	100-250A	5A/5mA	0.5	70
L-105	250-400A	5A/5mA	0.5	105
L-45	16-100A	5A/5mA	1	45
L-80	100-250A	5A/5mA	1	80
L-100	250-400A	5A/5mA	1	100
L-150	400-800A	5A/5mA	1	150
L-200	800-1500A	5A/5mA	1	200
L-80×50 II	16-100A	5A/5mA	0.5	82×52
L-100×50 II	16-200A	5A/5mA	0.5	103×55
L-130×50 II	100-200A	5A/5mA	0.5	135×55
L-150×130 II	100-300A	5A/5mA	0.5	150×133
L-180 II	100-200A	5A/5mA	0.5	181×35
L-210×160	450-800A	5A/5mA	0.5	210×160

Energy Management

1.APM Series Multifunction Meter

1.1 Model Description

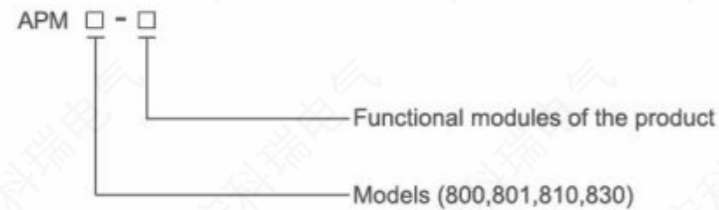

Shape	Panel size(mm)	Cut-out(mm)	Depth(mm)
96	96*96	92*92	65

1.2 Technical Parameter

Technical Parameter		Value
Signal	Connection	3 phase 3 wire, 3 phase 4 wire
	Frequency	45~65Hz
	Voltage	Rated value: AC 100V,110V,400V,690V
		Overload: 1.2 times rated value(continuous); 2 times rated value(1 second)
		Power consumption: < 0.5VA (per channel)
	Current	Rated value: AC 1A, 5A
Overload: 1.2 times rated value(continuous); 10 times rated value(1 second)		
Power consumption: < 0.5VA (per channel)		
Measurement accuracy	Voltage,current and power	Class 0.2
	Active power	Class 0.5S (APM800,APM810) Class 0.2S (APM801,APM830)
	Reactive power	Class 2 (APM800,APM810) Class 0.5 (APM801,APM830)
	Harmonic	1%(2~42nd),2%(43~63rd)
Switch inputs	Passive contact inputs, built-in power supply	
Relay outputs	Contact type: open contact in main part, changeover contact in module Contact capacity: 3A/AC 250V 3A/DC 30V	
Pulse output of energy	Output mode: Optocoupler pulse with open collector Pulse constant:4000(5A),8000(1A) imp/kWh	
Analog outputs	DC 0~20mA,4~20mA,0~5V,1~5V output, accuracy class 0.5%, load resistance ≤ 500Ω	
Analog inputs	DC 0~20mA,4~20mA,0~5V,1~5V input, accuracy class 0.5%	
Storage card	Standard capacity:4G,TF card up to 32G capacity	

Technical Parameter		Value
Communication		RS485(Modbus-RTU)
		Profibus(Profibus-DP)
		Ethernet(Modbus-TCP,HTTP,DHCP)
Auxiliary power supply		Operating range: AC/DC 85V~265V or AC/DC 115~415V(P2) Power consumption: Power consumption of the main part ≤ 15VA
Safety	Insulation resistance	>100MΩ
Electromagnetic compatibility		IEC 61000 standard (Level 4)
Protection level		IP54(Front)
Environment		Operating temperature: -25 °C ~ +55 °C
		Storage temperature: -20°C~+70°C
		Relative humidity: ≤95%(no condensation)
		Altitude: ≤2000m

1.3 Product Functions

Function	Function description	APM800 (class 0.5s)	APM801 (class 0.2s)	APM810 (class 0.5s)	APM830 (class 0.2s)
Parameters	All parameters	■	■	■	■
	Four-quadrant energy	■	■	■	■
	Multi-rate energy	□	□	□	■
Pulse output of energy	Active/reactive	■	■	■	■
Demand	Real-time and maximum demand of I, P, Q, S (with time)	■	■	■	■
Extreme value statistics	Extremum of I, UL-L, UL-N, P, Q, S, PF, F, THDi, THDu in this month and last month (with time)	■	■	■	■
Power quality	Unbalance of I,UL-L,UL-N	■	■	■	■
	Voltage phase angle,current phase angle	■	■	■	■
	Total and 2nd-63rd harmonic content of voltage and current	-	-	■	■
	Voltage crest factor	-	-	■	■
	Telephone waveform factor	-	-	■	■
	Current K-factor	-	-	■	■
	Positive sequence, negative sequence, zero sequence voltage and current	-	-	-	■
	Fundamental voltage and current	-	-	-	■
Waveform	Waveform trace display	-	-	-	■
	Fault waveform record	-	-	-	■
Alarm	A total of 66 kinds of alarm types, each type can record the most recent 16 alarm records, support extended records by TF card	■	■	■	■
Event	Record the most recent 128 event records, support extended records by TF card	■	■	■	■
Communication	RS485(Modbus-RTU)	■	■	■	■
I/O	2DI+2DO	■	■	■	■

Function	Function description	APM800 (class 0.5s)	APM801 (class 0.2s)	APM810 (class 0.5s)	APM830 (class 0.2s)	
Optional functions	F	muti tariff (shares) energies				<input type="checkbox"/>
	MD82	8DI+2DO				<input type="checkbox"/>
	MLOG	SD Card				<input type="checkbox"/>
	MAB4	8AI+4AO				<input type="checkbox"/>
	MCM	the second RS485				<input type="checkbox"/>
	MCE	Ethernet				<input type="checkbox"/>
	MCP	Profibus(Profibus-DP)				<input type="checkbox"/>
	MTN	4 channel 2M NTC temperature ,measurement				<input type="checkbox"/>
	MTD	2 channel PT100 temperature ,measurement				<input type="checkbox"/>
	MTH	1 channel temperature and humidity				<input type="checkbox"/>

Note: ① Accuracy of 2-42nd harmonic measurement in the frequency range of 45-65Hz is 1%, accuracy of 43-63rd harmonic measurement in frequency range of 50Hz is 2%.

② "■":standard, "-":No,"□":Optional.

1.4 Wiring

Wiring sample of voltage and current

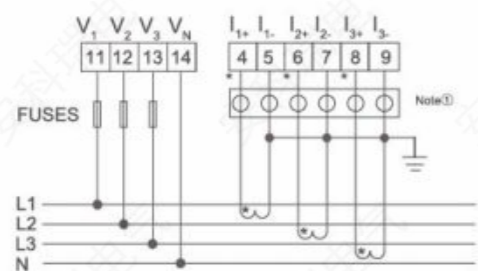

3P4W/3CT(Meter is set to 3P4W)

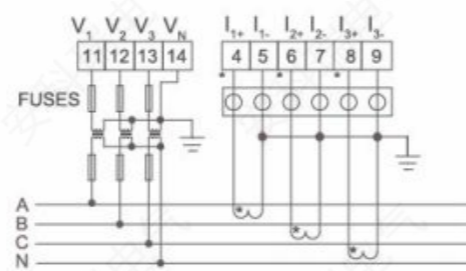

3P4W/3PT+3CT(Meter is set to 3P4W)

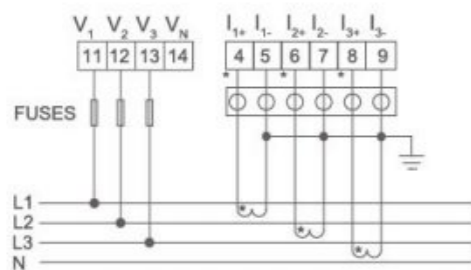

3P3W/3CT(Meter is set to 3P4W) Note②

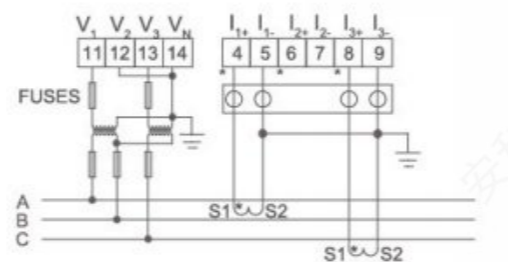

3P3W/2PT+3CT(Meter is set to 3P3W-3CT) Note③

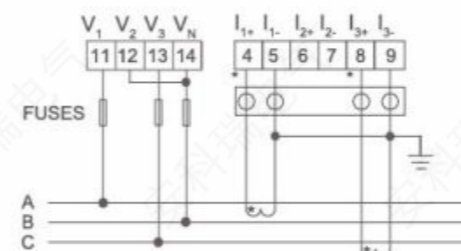

3P3W/2CT(Meter is set to 3P3W-2CT)

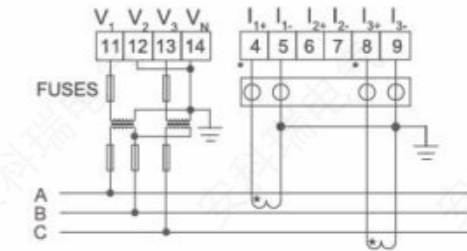

3P3W/2PT+2CT-1(Meter is set to 3P3W-2CT)

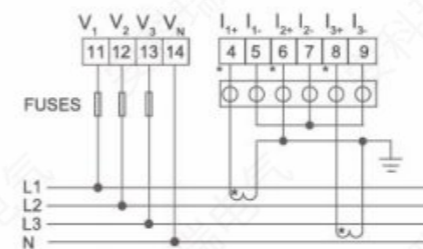

3P4W/2CT(Meter is set to 3P4W) Note②

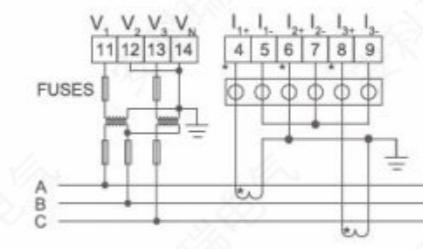

3P3W/2PT+2CT-2(Meter is set to 3P3W-3CT) Note③

Note ①: This is a test terminal for shorting the secondary side of the CT.

Note ②: Only for balanced three-phase loads.

Note ③: Phase B current is only displayed and does not participate in other calculations.

Module parts

Switch module

70	77	71	72	78	73	30	31	32	33	34	35	36	37	39
R1		R2		DI1	DI2	DI3	DI4	DI5	DI6	DI7	DI8	COM		
Relay Output						Digital Input								

Analog input and output module

60	61	62	63	64	65	66	67	69	50	51	52	53	59
AI1	AI2	AI3	AI4	AI5	AI6	AI7	AI8	COM2	A01	A02	A03	A04	COM3
Analog Input						Analog Output							

Ethernet module

24	25	26	LAN	PROFIBUS DP
A2	B2			
RS485				

2.ADL Series Din Rail Energy Meter

2.1 ADL10-E、ADL100-ET、ADL3000-E



ADL10-E



ADL100-ET



ADL3000-E

2.1.1 Technical Parameter

Technical parameter	Type		
	ADL10-E	ADL100-ET	ADL3000-E
Voltage	Reference voltage	220V	
	Reference frequency	50Hz	
	Consumption	<10VA (Single phase)	
Current	Maximum current	60A	6A,80A
	Starting current	0.004Ib	Direct connect:0.004Ib Connect via CT:0.001In
	Consumption	<4VA (Maximum current)	<1VA (Single phase rated current)
Measurement performance	Standards compliant	IEC 62053-21:2003	
	Accuracy of Active kWh	Class 1	
Pulse	Pulse width	80±20ms	
	Pulse constant	3200imp/kWh	1600imp/kWh
Communication	Interface	RS485	
	Protocol	MODBUS-RTU	
Outline	Length *Width * Height(mm)	18*88*70	36*88*70
Environment	Temperature	Operating:-25°C~55°C;Storage :-40°C~70°C	
	Humidity	≤95% (No condensation)	
	Altitude	<2000m	

2.1.2 Product Functions

■ ADL10-E

Function	Description	Provide
Measurement of kWh	Single-phase active energy (positive and negative)	■
Measurement of electrical parameters	U,I,P,Q,S,PF,Hz	■
LCD Display	8 digits	■
Communication	RS485, MODBUS-RTU	□C

Note:(■: standard; □: optional)

■ ADL100-ET

Function	Description	Provide
Measurement of kWh	Single-phase active energy (positive and negative)	■
Measurement of electrical parameters	U,I,P,Q,S,PF,Hz	■
LCD Display	8 digits	■
Button	3 keys	■
Pulse output	Active energy pulse output	■
Communication	RS485, MODBUS-RTU	□c
	Infrared	■

Note:(■: standard; □: optional)

■ ADL3000-E

Function	Description	Provide
Measurement of kWh	Active kWh (positive and negative)	■
	Reactive kWh (positive and negative)	■
	A, B, C phase positive kWh	■
Measurement of electrical parameters	U,I,P,Q,S,PF,HZ	■
Measurement of harmonic	2~31st voltage and current harmonic	□
LCD Display	8 digits	■
Button	4 keys	■
LED alarm	voltage loss and over voltage	■
Switch I/O	Active switch input	□
	Switch output	□
Data	Maximum demanded kWh and time happened	□
	Frozen data on last 48 months, last 90days	□
	Date, time	□

Function	Description	Provide
Communication	Infrared	■
	RS485, MODBUS-RTU	□
Temperature measurement	Support 3 outlay NTC temperature	□

Note: (■: standard; □: optional)

2.1.3 Wiring

ADL10-E

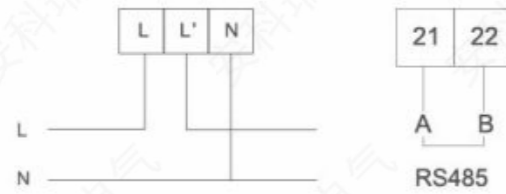

ADL100-ET

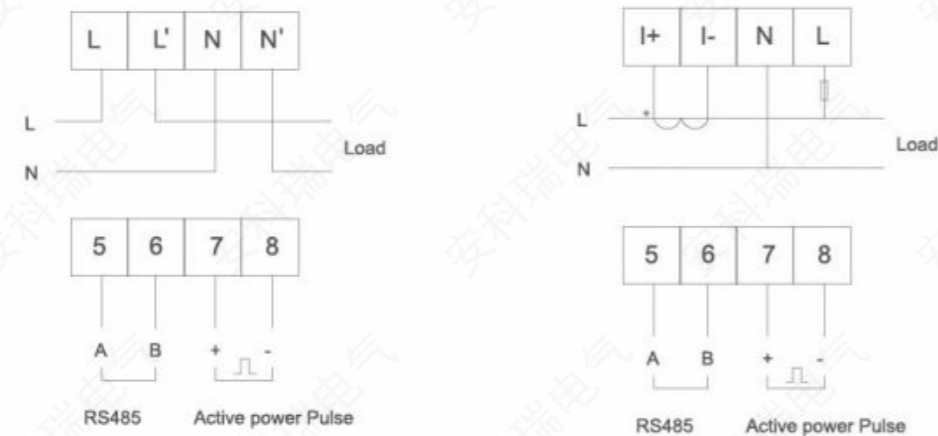

10(60)A specification wiring diagram

20(100)A specification wiring diagram

ADL3000-E

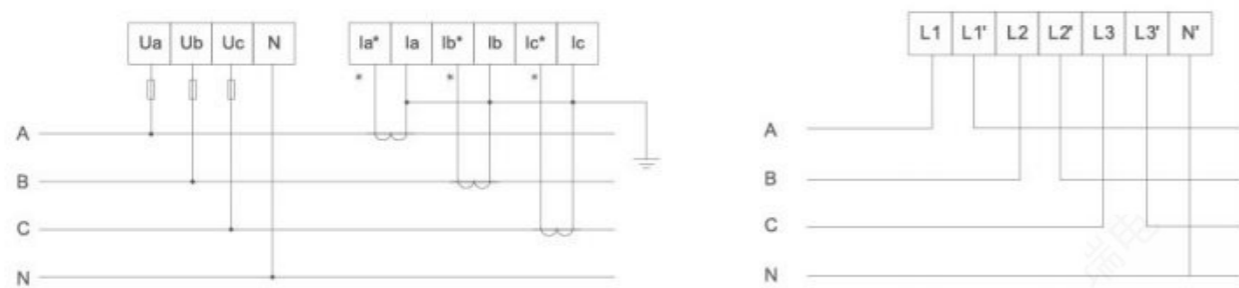

Three phase four lines connect via CT

Three phase four lines direct connect

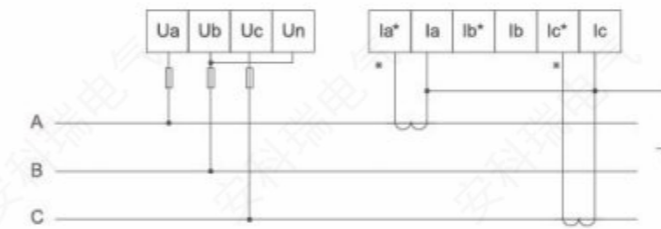

Three phase three lines connect via CT

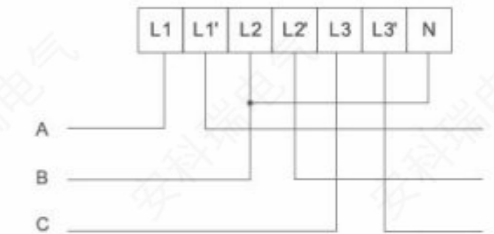

Three phase three lines direct connect

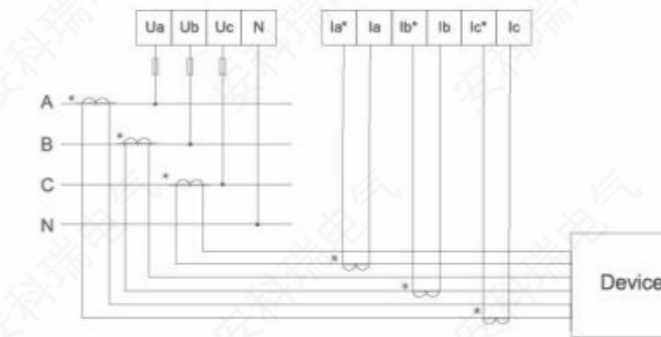

Three phase four lines, 3CT

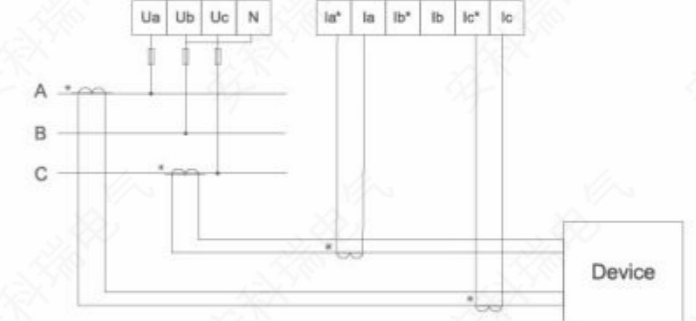

Three phase three lines, 2CT

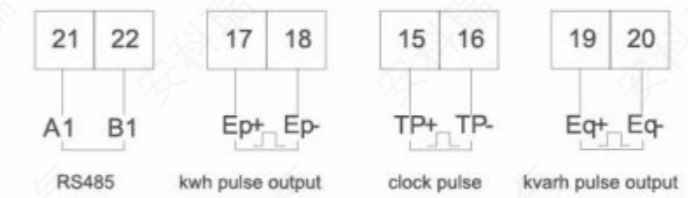

Communication, pulse connection

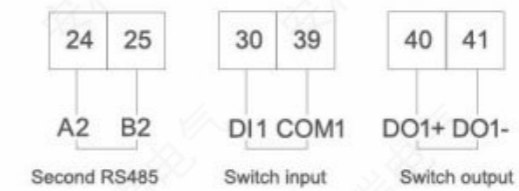

Communication, pulse connection

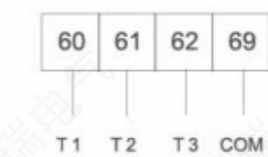

Outlay NTC temperature measurement

2.2 ADL200

2.2.1 Model Description



2.2.2 Technical Parameter

Input voltage	Reference voltage	AC220V
	Reference frequency	50Hz
	Power consumption	<10VA
Input current	Basic current	10A
	Maximum current	80A
	Starting current	4% <i>I_b</i>
	Consumption	<4VA
Measurement performance	Accuracy of measuring	1 class
	Range of measuring	000000.00~99999999kWh
Clock accuracy		Error ≤ 0.5s/d
Output	Pulse width	80±20ms
	Pulse constant	1000imp/kWh
Auto-reclosing brake	Interface	RS485(A+, B-)
	Connection mode	Shielded twisted pair conductors
	Protocol	MODBUS-RTU
	Length×Width×Height	90mm×36mm×65mm
Strong current terminal Torque		<1.8Nm

2.2.3 Function

Function	Function description	Value
Measurement of kWh	Single-phase active kWh (positive and negative), 3 months historical energy data frozen storage	■
Measurement of electrical parameters	Voltage, Current, Active power, Reactive power, Apparent power, Power factor and Frequency	■
LCDDisplay	8 bits section LCD display	■
Key programming	3 keys to set parameters like code, address, baud rate, multi-tariff and communication protocol	■
Pulse output	Active energy pulse output	■
Multi-tariff	Adapt 4 time zones, 2 time interval lists, 14 time interval by day and 4 tariff rates	□F
Communication	Communication interface: RS485, Communication protocol: MODBUS-RTU	■

2.2.4 Wiring

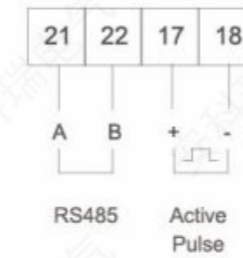

2.3 ADL400

2.3.1 Model Description

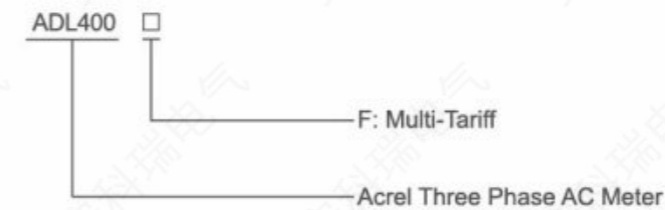

2.3.2 Technical Parameter

project		performance parameter	
Specification		3 phase 3 wires, 3 phase 4 wires	
Measurement	Voltage	Reference voltage	3×100V、3×380V、3×57.7/100V、3×220/380V
		Consumption	<10VA (Single phase)
		Impedance	>2MΩ
	Current	Accuracy class	Error ± 0.2%
		Input Current	3×1(6)A, 3×10(80)A
		Consumption	<1VA Single phase rated current
	Accuracy class	Error ± 0.2%	
Power	Active, reactive, apparent power, error ± 0.5%		
Frequency	45~65Hz, Error ± 0.2%		
Metering	Energy	Active energy (Accuracy class: 0.5) reactive energy (Accuracy class: 2)	
	Clock	≤ 0.5s/d	
Digit signal	Energy pulse output	1 active photocoupler output	
pulse	Width of pulse	80±20ms	
	Pulse constant	400imp/kWh, 10000imp/kWh (Correspond with the basic current)	
Communication	Interface and communication protocol	RS485 : Modbus RTU	
	Range of communication address	Modbus RTU: 1~247;	
Environment	working temperature	-25℃ ~ +55℃	
	Relative humidity	≤ 95% (No condensation)	

2.3.3 Function

Function	Functiondescription	Functionprovide
Measurement of kWh	Active kWh(positive and negative)	■
	Reactive kWh(positive and negative)	■
	A,B,C split phase positive active energy	■
Measurement of electrical parameters	U、I	■
	P、Q、S、PF、F	■
Measurement of harmonics	2~31 st Voltage and current harmonic	■
Key programming	12 bit ssection LCD display, background light	■
	3 keys to communication and set parameters	■
LCD Display	Active pulse output	■
Multi-tariff and functions	Adapt 4 time zones, 2 time intervallists,14 time interval by day and 4 tariff rates	□
	Max demand and occurrence time	□
	Frozen data on last 48 months,last 90 days	□
	Date,time	□
Communication	Communication interface: RS485,Communication protocol:MODBUS-RTU	■

2.3.4 Wiring

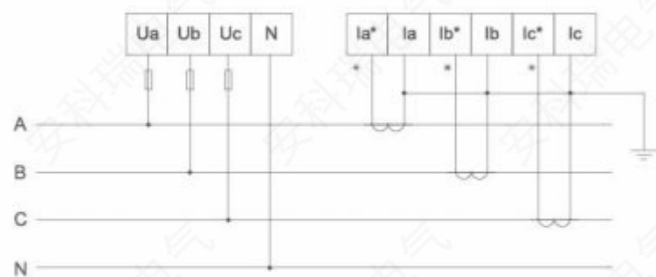

Fig3 Three phase four lines connect via CT

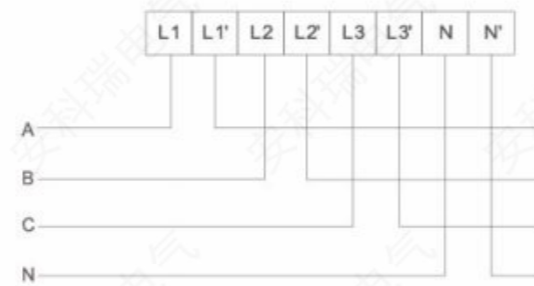

Fig4 Three phase four lines direct connect

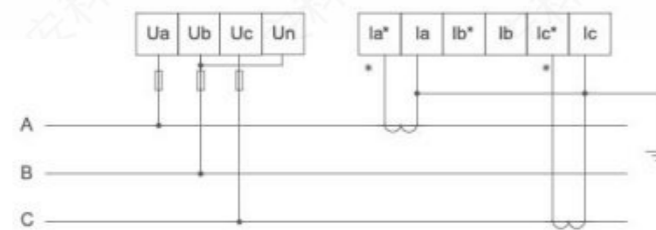

Fig5 Three phase three lines connect via CT

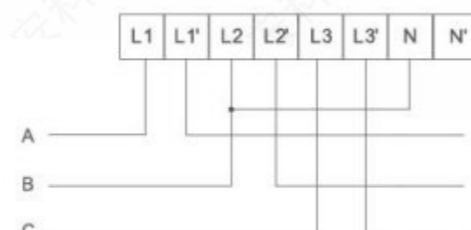

Fig6 Three phase three lines direct connect

Wiring diagram of communication and pulse terminals

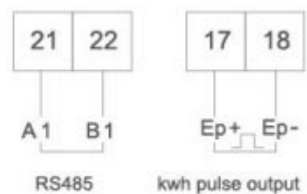

Fig 7 Communication, pulse connection

3.ADL Series Prepayment Meter



ADL100-EY



ADL300-EY

3.1 Technical Parameter

Technical parameter		ADL100-EY	ADL300-EY
Voltage	Nominal voltage	220V	3*220/380V
	Nominal frequency	50/60Hz	
	Consumption	<4VA(Each phase)	
Current	Maximum current	60A	6A,80A
	Consumption	Connect directly: 0.04A, connect via CT: 0.002A	
Measurement performance	Accuracy	Class 1	Class 0.5s
	Clock	Accuracy	Error ≤0.5s/d
Active pulse	Width	80ms±20ms	
	Constant	1600imp/kWh	6400imp/kWh,400 imp/kWh
Outline	Length*Width*Height (mm)	72*88*70	144*88*70
Communication	Interface	RS485	
	Protocol	MODBUS-RTU	
Temperature range	Working	-25°C~55°C	
	Storage	-40°C~70°C	
Relative humidity		≤95%(No condensation)	
Altitude		≤2000m	

3.2 Product Functions

Function	Description		Provide
	ADL100-EY	ADL300-EY	
Measurement of kWh	Total active kWh (positive and negative in total)		■
Electrical parameters	U,I ,P,Q,S,PF,Hz		■
Pre-paid mode	Through RS485 communication prepaid recharge, data encryption		■
Control	Magnetic latching relay		■
LCD display	8 digits		■
Communication	RS485(Modbus-RTU)		■

Note: (■: standard; □: optional)

3.3 Wiring

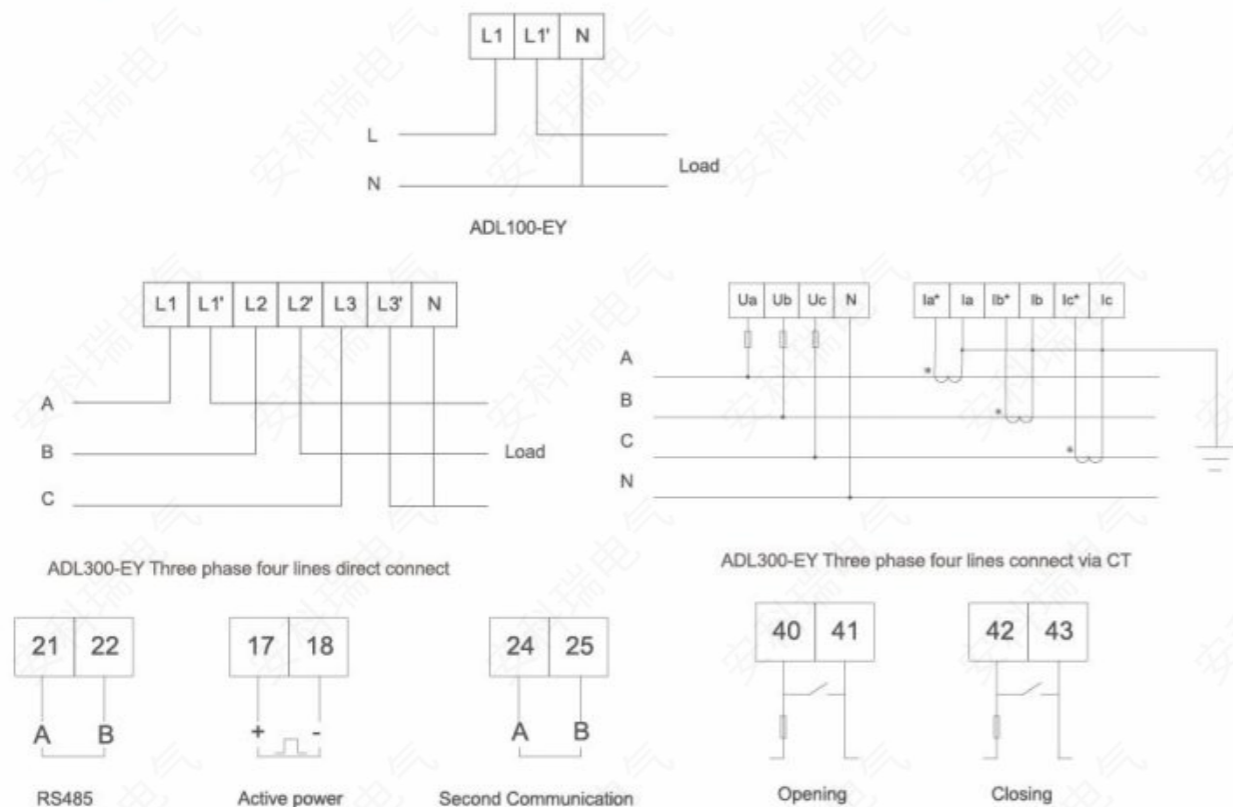

4.ADF Series Multi-circuits Energy Meter

4.1 Model Description

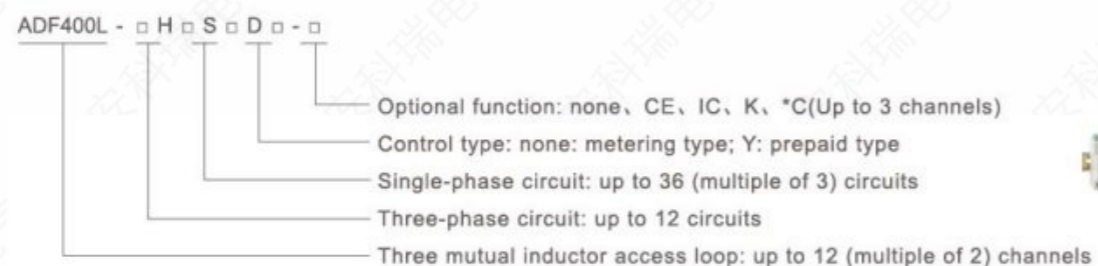

4.2 Technical Parameter

Technical Parameter	Model	ADF400L-HSD(Y)-
Auxiliary power	Voltage	Three-phase 3*220V/380V power supply (for single-phase power supply, short-circuit terminals 1, 2, and 3 on the instrument)
	Power consumption	≤10W

Technical Parameter	Model	ADF400L-HSD(Y)-
Voltage input	Rated voltage	3×220/380V、3×57.7/100V、
	Reference frequency	50Hz
Current input	Input Current	3×1(6)A(Instrument transformer access), 3×10 (80) (direct access)
	Starting current	1%Ib
Measuring performance	Measurement accuracy	0.5s level
	Clock accuracy	≤0.5s/d
Pulse	Pulse output	Each three-phase metering module has 1 active energy pulse
	Pulse Width	80ms±20ms
	Pulse constant	3×1(6)A specification 6400 imp/kWh 3×10(80)A specification 400 imp/kWh
Switch	Main module	Main module 2DI+2DO, Among them, DI is dry contact input
	Slave module	Transformer access slave module 4DI+4DO, Among them, DI is 220V wet contact input
Communication	Infrared interface	Infrared communication
	RS485 interface	MODBUS-RTU
	Ethernet interface	Modbus-TCP、TCP/IP
Surroundings	Temperature	Operating temperature: -10℃~+45℃, storage temperature: -30℃~+70℃
	Humidity	≤95%RH, No condensation, no corrosive gas place
	Altitude	≤2000m

4.3 Product Functions

Prepaid

Function	Function description
Energy metering	Total active energy, forward and reverse active energy, multi-rate active energy measurement
Electricity measurement	U、I
	P、Q、S、PF、F
LCD display	8-digit segment LCD display, backlight display
Button programming	Key programmable communication, number of loops, single three-phase mode, external control mode and other parameters
Pulse output	Active pulse output
Multiple rate	Support 4 time zones, 2 time slots, 14 daily time slots, 4 rates
	Date, time, day of the week
Main module	Infrared communication

Function	Function description
Communication	Up to 3 channels of communication: RS485 interface , Also support Modbus
Prepaid agreement (remote, radio frequency card)	Cost control (including forward active power and reverse active power)
	Time control
	Negative control (malignant load identification)
Recharge record	Strong control
	20 Article

■ Metering type

Function	Function description
Display method	LCD (Field)
Energy metering	Active energy metering (Forward and reverse) , Reactive power measurement (Forward and reverse)
Electricity measurement	Voltage, current (zero sequence current), power factor, frequency, active power, reactive power, apparent power
Harmonic function	Total harmonic content, sub-harmonic content (2~31 times)
Three-phase unbalance	Voltage and current unbalance
DI/DO	Main module 2DI2DO
	Transformer access to the slave module 2DI4DO (direct access to the slave module without)
LED Instructions	Pulse light indication
Communication	Infrared communication
	RS485 interface (main module) supports MODBUS
Historical power	Historical Electricity in Last December

4.4 Wiring

■ Main module

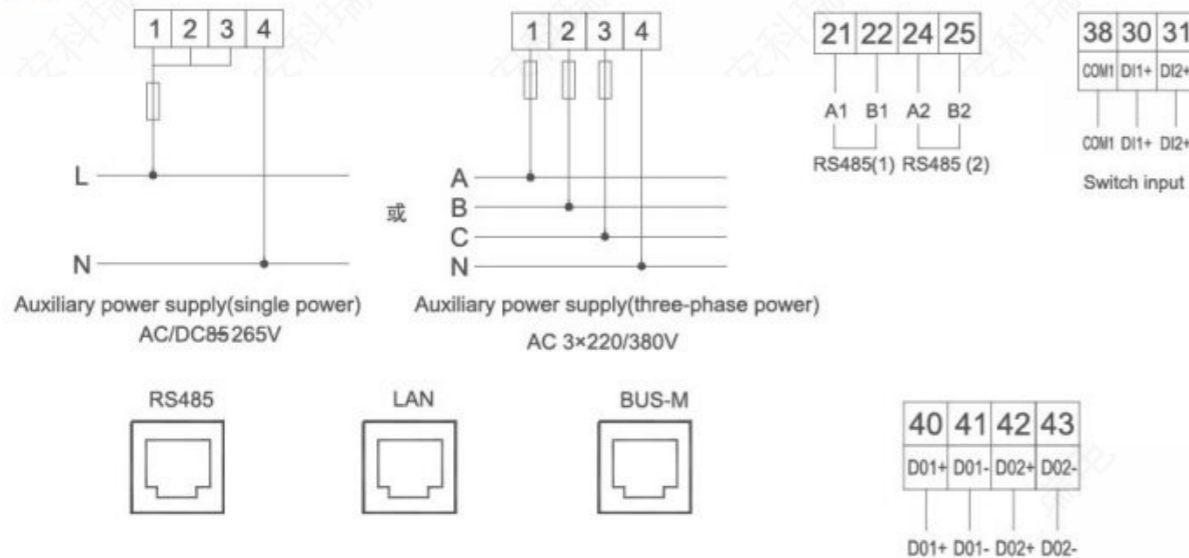

■ Transformer access module

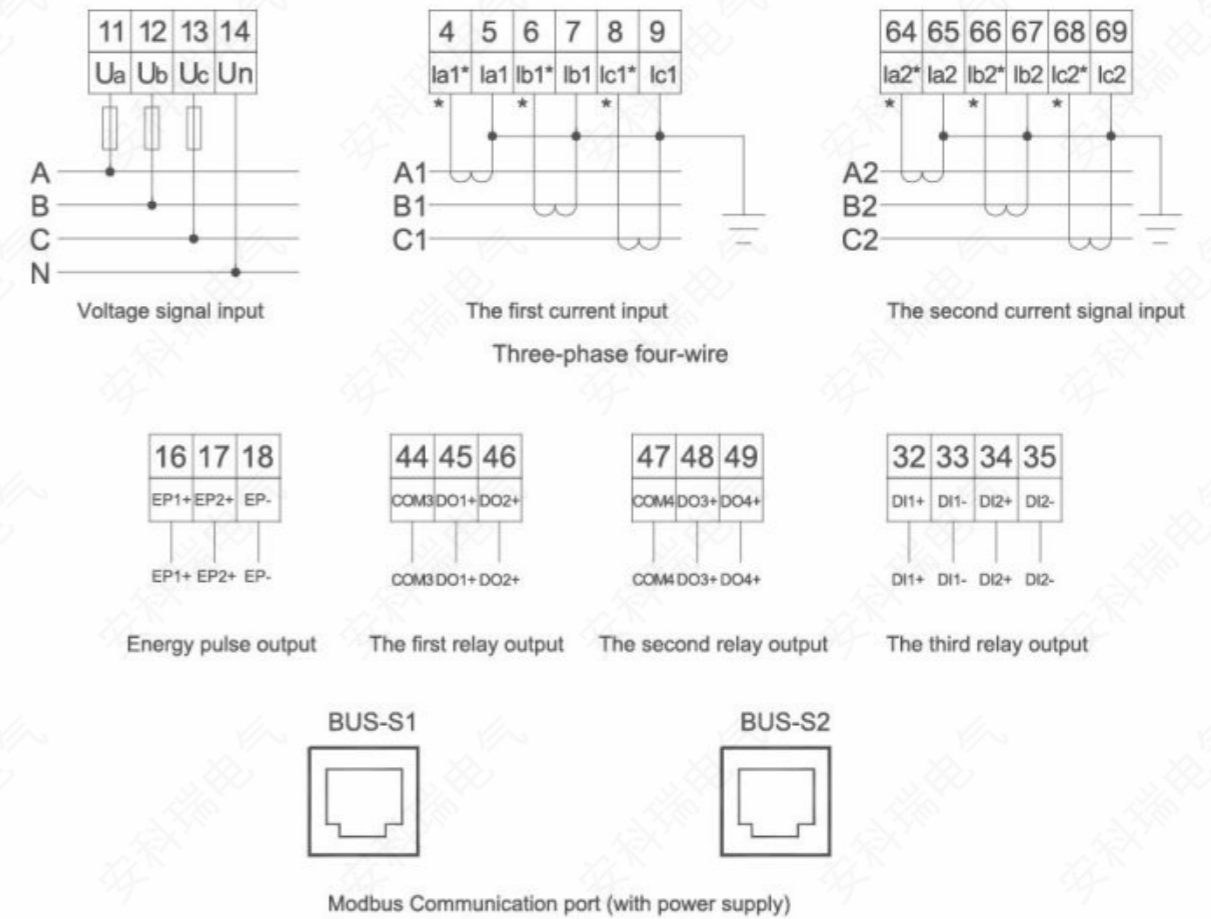

■ Direct access to the module

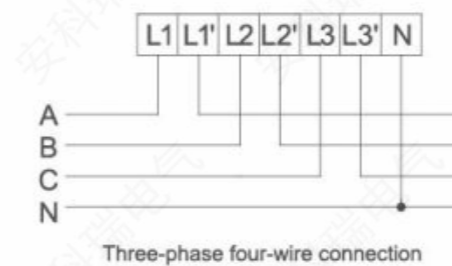

■ Wiring diagram

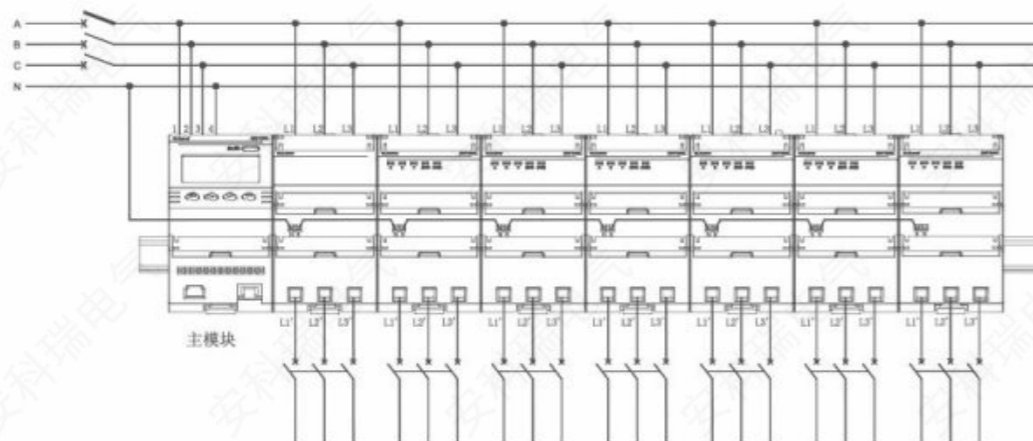

36-channel single item direct access diagram

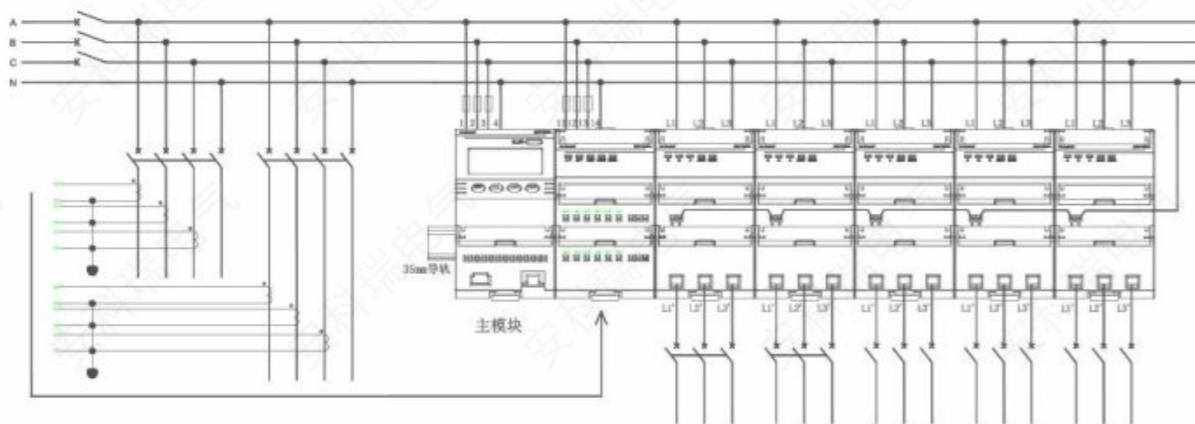

2 channels of transformer access + 2 channels of three items direct access + 6 channels of single item direct input

➤ 5.ADW Series IoT Power Meter



ADW200

ADW210

ADW220

ADW300

➤ 5.1 ADW2XX Series Wireless Energy Meter

● 5.1.1 Naming rule

ADW □ - □ - □ - □

Extension module: one out of four communication module
 MK: switching module, 12 inputs + 4 outputs
 MTL: temperature and leakage module,
 12 temperature + 4 leakage current

Number of current input circuits:
 1S: 1 three-phase current circuits
 2S: 2 three-phase current circuits
 3S: 3 three-phase current circuits
 4S: 4 three-phase current circuits

Current transformer:
 D10: 5A/1.25mA input
 D16: 100A/20mA input
 D24: 400A/100mA input
 D36: 600A/100mA input

Model description : 1 RS485+1 pulse+2 inputs +2 outputs
 200: no display and Lora wireless communication function
 210: LCD display function
 220: Lora wireless communication function

Acrel product serial number

● 5.1.2 Technical Parameter

◆ Subject Technical parameters

input	Frequency	45~65Hz;
	Voltage	AC 3×220V/380V; consumption: ≤ 0.5VA;
	Current	AC 5A、100A、400A、600A;(External split core transformer) consumption: ≤ 0.5VA;
Accuracy	Frequency: 0.05Hz, voltage and current: 0.5 level, active electric energy: level 1, reactive electric energy: level 2; 2-31 times harmonic accuracy: ± 1%;	
Features	Pulse output	Output mode: optocoupler pulse with open collector;
	Communication	RS485(Modbus-RTU), Baud rate 1200~38400;
		Switching
Outline	L*W*H(mm)	72*97.7*71.5
Environment	working temperature	-10℃~+45℃;
	Storage temperature	-40℃~+70℃;
	relative humidity	≤95% No condensation;
	Altitude	≤2500m;

◆ Module technical parameters

Switching Module	Power	RJ45 interface, DC 12V, Power consumption≤1W;
	Communication	RJ45 interface, Modbus-RTU;(Communication with the main Part)
	Switching input	Dry contact input, Built-in power supply;
	Switching output	Output mode:Relay normally open contact output; contact rating:AC 250V/3A DC 30V/3A;
Temperature and leakage module	Power	RJ45 interface, DC 12V, Power consumption≤1W
	Communication	RJ45 interface, Modbus-RTU;(Communication with the main Part)
	temperature measurement	-20~100 C;
	Leakage measurement	10~3000mA;
	measurement accuracy	temperature ±2 C、Leakage1.0%;

◆ 5.1.3 Product function

Function	Description
LCD display	8 digits
Measurement of energy	kWh (positive and negative)
	kvarh (positive and negative)
Electrical parameters	A, B, C phase positive kWh
	U,I,P,Q,S,PF,Hz
Harmonic	2-31 st voltage and current harmonic
Key programming	4 keys to communication and set parameters
Residual current	1-channel
LED alarm	Over-voltage,over-current,phase failure,DI linkage and other alarm output;
Data	Maximum Current, Maximum power demand and real time Current, real time power demand;
SOE	200 event records,record the action of DI/DO
Multi-tariff	4 time zones 14 periods rate setting;
DI/DO	2DI/2DO

◆ 5.1.4 Dimension and installation instructions

◆ Dimension(unit:mm)

(1) Dimensions of ADW2xx series main part and Module

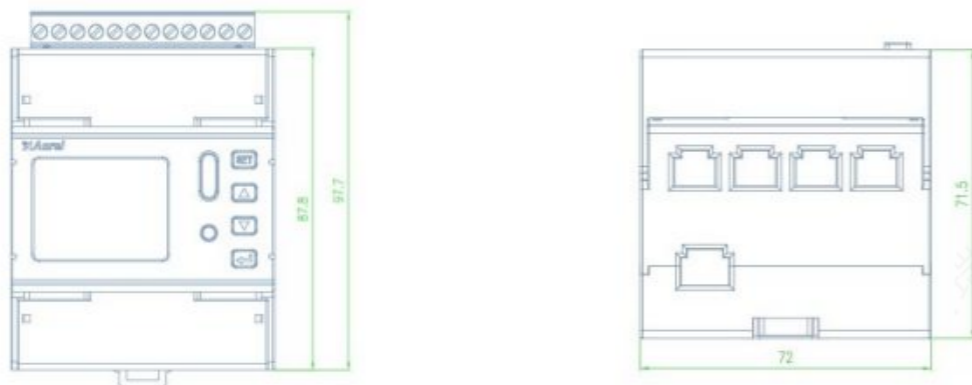

Picture1 Dimensions of ADW2xx series main part



Picture2 Dimensions of ADW2xx series Module

◆ Installation instructions

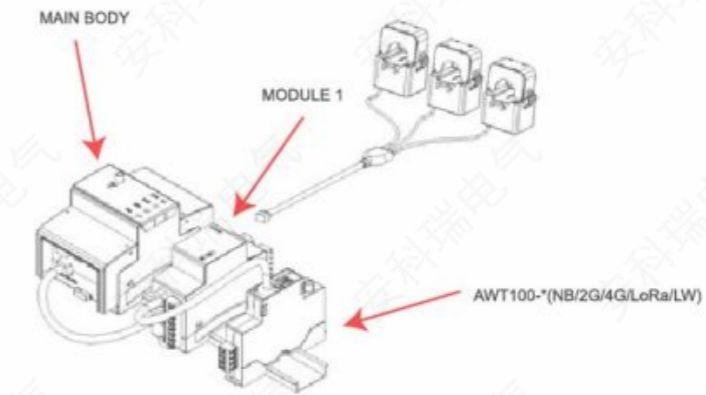

Picture3 Guide rail installation

◆ 5.1.5 Wiring

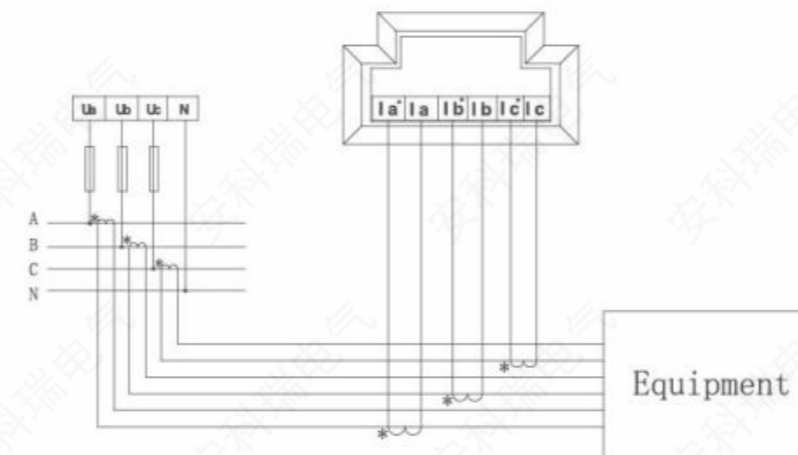

Picture 4 Three-phase four-wire (secondary current access)

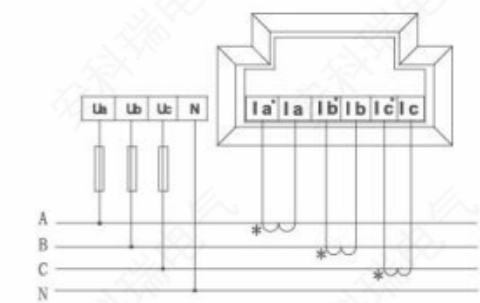

Picture 5 Three-phase four-wire (direct current connection)

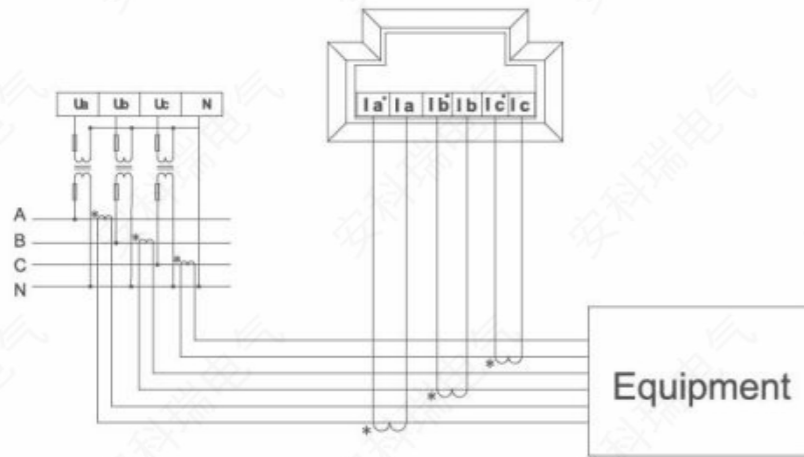

Picture 6 Three-phase four-wire (secondary connection of voltage and current)

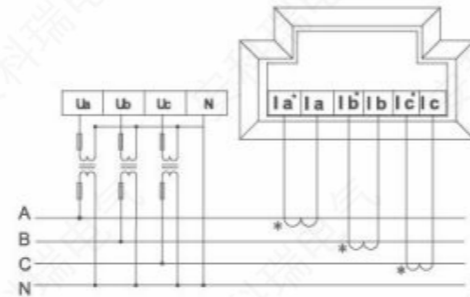

Picture 7 Three-phase four-wire (direct connection of voltage and current)

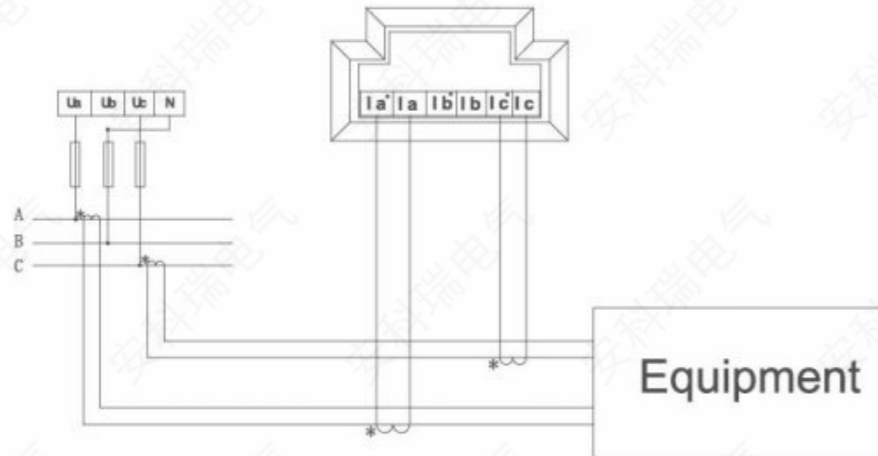

Picture 8 Three-phase three-wire (current is connected via transformer)

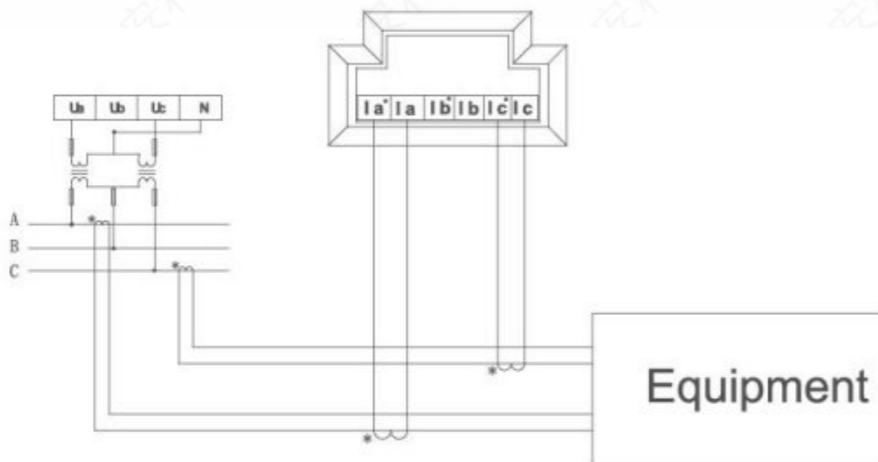

Picture 9 Three-phase three-wire (voltage and current are connected through the transformer)

➤ 5.2 ADW300 Wireless Energy Meter

• 5.2.1 Naming rule

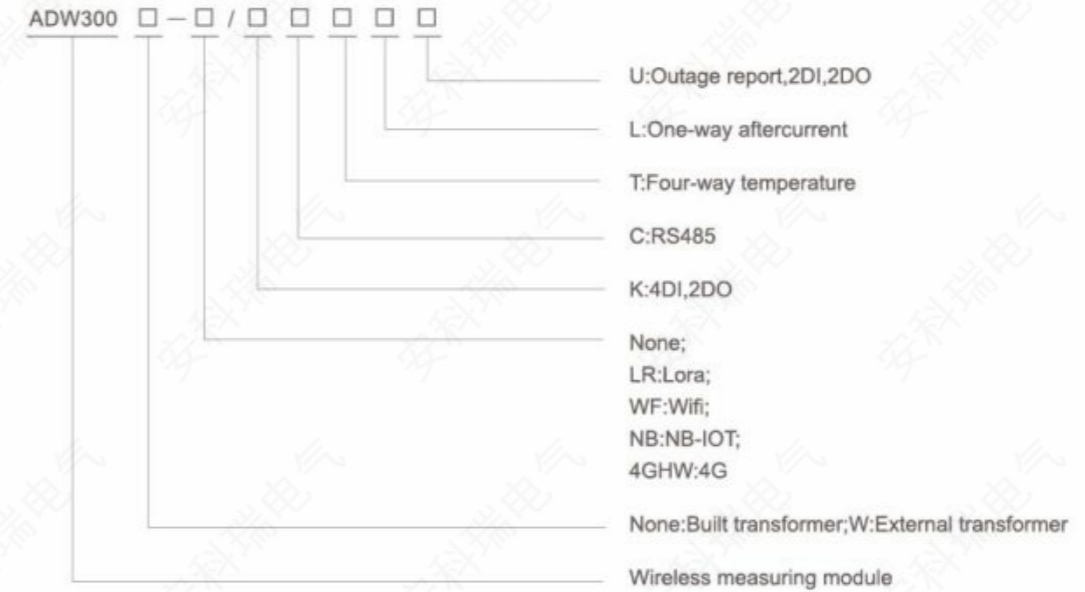

• 5.2.2 Technical Parameter

Voltage input	Rated voltage	3×57.7/100V, 3×220/380V, 3×380/660V, 3×100V, 3×380V, 3×660V
	Reference frequency	50Hz
	Power waste	each phase<0.5VA
Current input	Input current	3×1(6)A; 3×1(6)A (ADW300W), 3×20(100)A (ADW300W)
	Start current	1%Ib(Class 0.5S), 4%Ib(Class 1)
	Power waste	each phase<1VA
Auxiliary power supply	Supply voltage	AC 85~265V, AC380V, DC24V
	Power waste	<2W
	Active energy accuracy	Class 0.5S (ADW300), class 1 (ADW300W)
	Temperature Accuracy	±2℃
pulse	pulse width	80±20ms
	Impulse constant	3×20(100)A: 400imp/kWh, 3×1(6)A: 6400imp/kWh
Communication	wireless	Transmission on 470MHz and maximum distance in open space is 1km; LR; NB; 4GHW; WF
	Infrared communication	The constant baud rate is 1200
	Interface	RS485(A, B)
	Connection mode	Shielded twisted pair conductors
Temperature range	Protocol	MODBUS-RTU, DL/T 645-07
	Operating temperature	-10℃~45℃
	Storage temperature	-40℃~70℃
	Humidity	≤95% (No condensation)
	Altitude	≤2000m

• 5.2.3 Product Functions

Function	Functional description
Display	LCD (Field form), 8 digits
Electric energy metering	Active power metering (positive and reverse); four quadrant reactive power
Electricity measurement	U, I, P, Q, S, PF, Hz
Harmonic function	Total harmonic content and fractional harmonic content (2-31 times)
Pulse output	Active Power Pulse Output
Three-phase unbalance	Voltage and current imbalance
Temperature measurement function	A, B, C, N four-way temperature measurement (optional T)
DI/DO	4DI/2DO(Optional K), 2DI/2DO(Optional U)
Residual Current	1-way Residual Current Measurement
LED instruction	Pulse and other indication
External CT	External open type CT(Selection of W)
Electrical parametric alarm	Under-voltage, over-voltage, undercurrent, over-current, under-load, overload, etc
	Infrared Communication
	RS485 (Optional C)
	470MHZ (Optional LR)
	NB-IOT (Optional NB)
Communication	4G (Optional 4GHW)
	WiFi (Optional WF)

• 5.2.4 Pictures

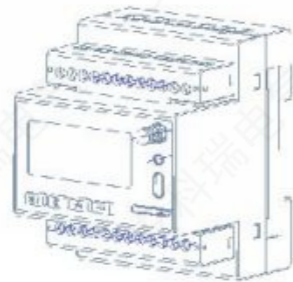

Picture 1 Effect of ADW300

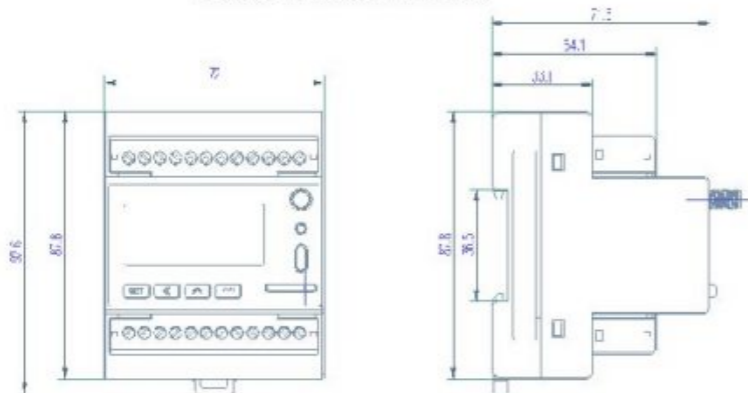

Picture 2 ADW300 dimension drawing

• 5.2.5 Wiring

(1) ADW300

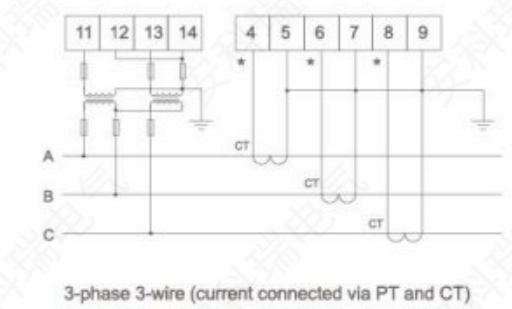
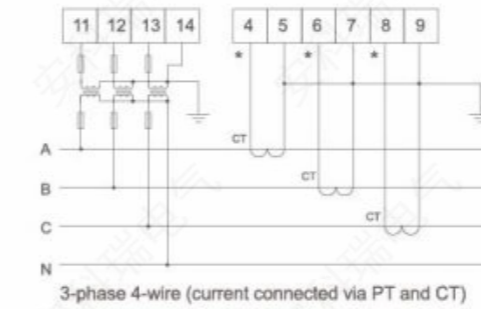
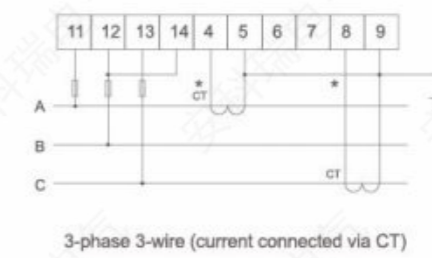
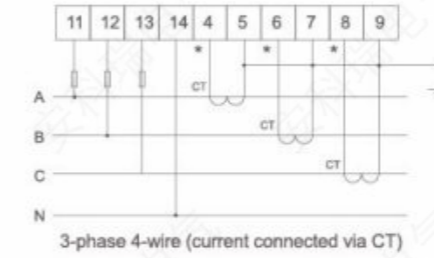

(2) ADW300W

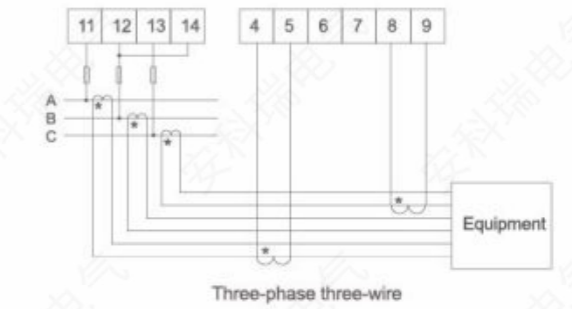
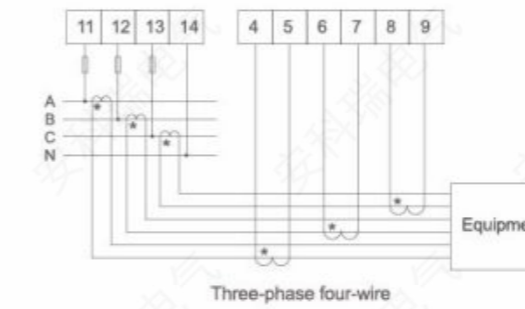

» 6.DJSF Series DC Energy Meter

• Model Description



Product Functions

Technical parameters		Index		
Input	Rated value	Voltage input	Current input	
		DC 0-1000V	Shunt: 0-75mV; Hall sensor: 0-20mA, 4-20mA, 0-5V, 0-10V etc.	
	Overload	1.2 times rated (continuous); 2 times rated/1 second;		
Power consumption		Voltage: ≤0.2VA, current ≤0.1VA		
Accuracy class		Class 1, Class 0.5		
Function	Display	8-bit segment LCD screen (LCD)		
	Communication interface	RS485, infrared		
	Communication protocol	Modbus-RTU, DL/T 645-2007		
	Switch	Switch output	2 Relay outputs, 2A/30VDC or 2A/250VAC	
		Switch input	2 dry contact inputs	
Pulse output	A second pulse output, a energy pulse output See the SYS->PLUS display in the meter menu settings. For example: The meter displays 100, which is 100imp/kWH			
Power Supply	Voltage range	AC/DC 85-265V or DC24V(±10%) or DC48V(±10%)		
	Power consumption	≤ 3W		
Environment	Temperature	Normal operating temperature: -25 °C ~ +55 °C;		
		Limit working temperature: -10 °C ~ +45 °C;		
	Storage temperature: -40 °C ~ +70 °C			
	Humidity	≤93%RH, no condensation, no corrosive gas		
Altitude	≤2000m			

Terminals and wiring

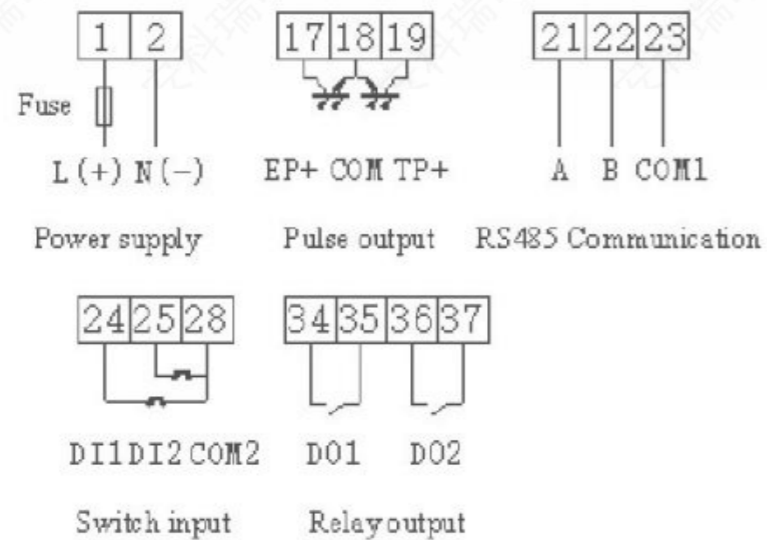

Note: The second DC input channel and DI and DO functions are optional.

(1) When the current input mode is current shunt input:

◆ Three-wire connection

Current shunt connected to the positive:

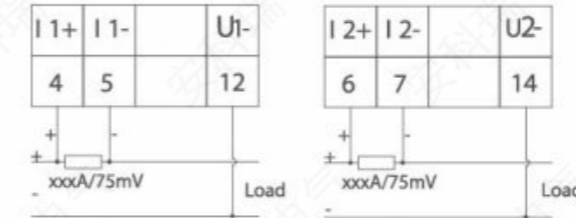

First DC input channel

Second DC input channel

◆ Four-wire connection

Current shunt connected to the positive:

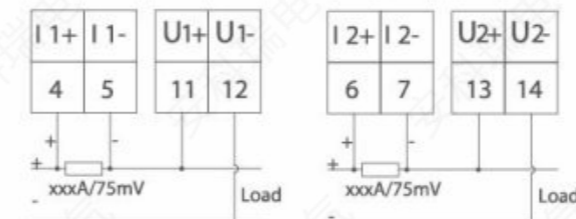

First DC input channel

Second DC input channel

Current shunt connected to the positive:

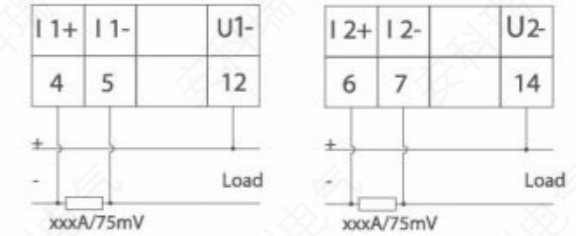

First DC input channel

Second DC input channel

Current shunt connected to the negative:

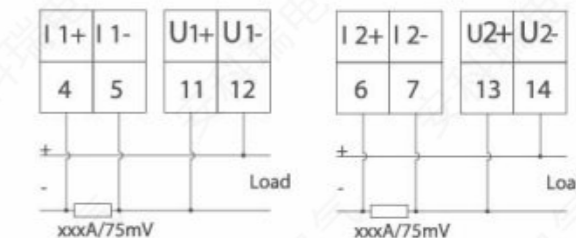

First DC input channel

Second DC input channel

(2) When the current input mode is current shunt input:

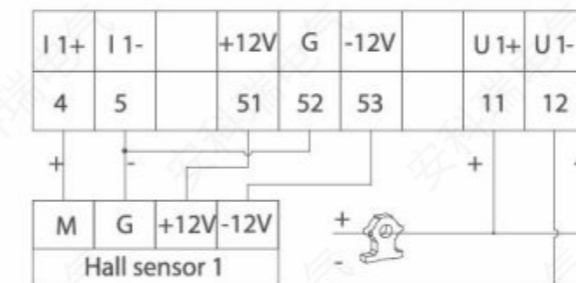

First DC input channel

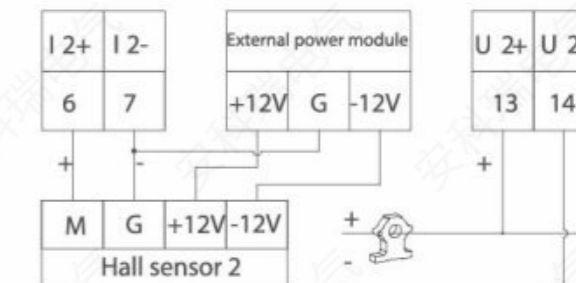

Second DC input channel

New Energy

1.AGF-AE Series PV/Solar Inverter Energy Meter

1.1 Model Description

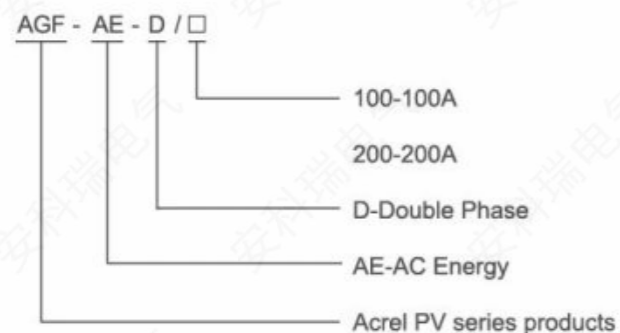

1.2 Technical Parameter

Meter Electrical Service		Units	
	AGF-AE-D/100	AGF-AE-D/200	
Rated Voltage-Line to N	120	V	
Rated Voltage-Line to Line	208/240	V	
Extended Voltage Range	88%~110%		
AC Frequency	60	Hz	
Grids Supported	L1/L2/N/PE		
Power Consumption	1.2	W	
Communication			
Meter Communication Interfaces	RS 485		
Response Time	≤1	S	
Meter Accuracy			
Rated RMS current	100	200	A
1%-100% of CT Current	±0.5	±1	%
Current Transformers			
Number of Supplied Current Transformers	2		
Dimensions	I.D:15 O.D:35	70.5×54.5×39 (H×W×D)	mm
Standard Compliance			
Safety	UL1741		
Installation Specifications			
Dimensions(H×W×D)	54.1×87.8×52		mm
Weight	0.2		kg
Operating Temperature Range	-30~55		℃
Relative Humidity (noncondensing)	5 - 90		%
Mounting Type	DIN-Rail, 35mm		

1.3 Product Functions

Function	Description
Measurement of energy	kWh(positive and negative)
	kVarh(positive and negative)
Electrical parameters	U,I,P,Q,S,PF,Hz
Protocol	RS485 (SUNSPECT)
Supply System	single phase 3-line

1.4 Wiring

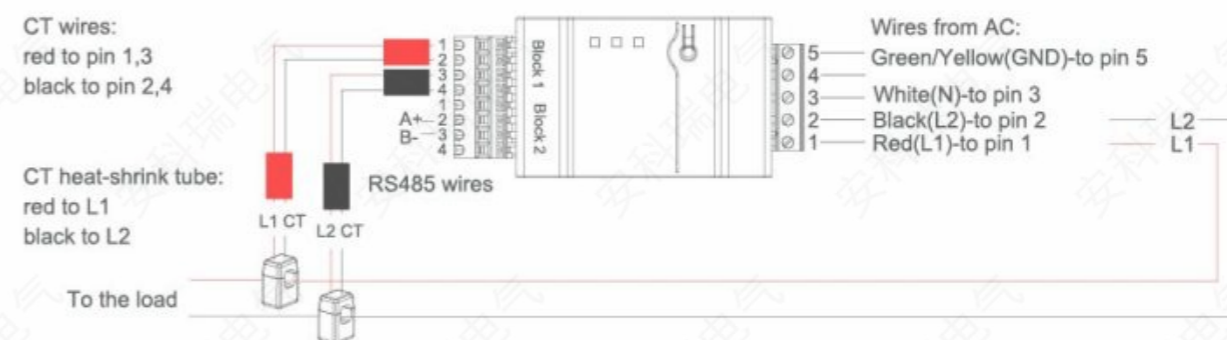

2.AGF Series Solar String Monitoring Device

2.1 Model Description

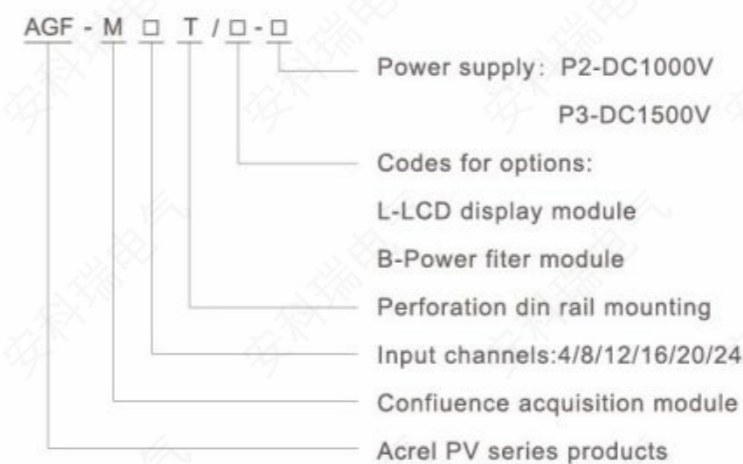

* The power filter module is only used when there are additional filtering requirements for the power supply.

2.2 Technical Parameter

Item	AGF-M4T	AGF-M8T	AGF-M12T	AGF-M16T	AGF-M20T	AGF-M24T
Input channels	4	8	12	16	20	24
Rated current	DC 0~20A					
Response time	1s					
Accuracy	0.5 class					
Temperature coefficient	400ppm					
RS485 communication	RS485/ModBus-RTU protocol, 4800/9600/19200/38400bps					
Additional function						
Switch input	3-way input(optocoupler or dry contact mode)					
General technical parameters						
Temperature/ Humidity	Working temperature: -35~+65℃, humidity95%,no condensation, no corrosiogas place; *Display module work temperature:-20~+70℃					
Temperature measurement function	To measure the inner temperature of box (-20℃~100℃)					
Altitude	≤3000m					
Insulation resistance	≥100MΩ					

2.3 Product Functions

Function	Description
Display	6LED (LCD displayOptional)
Electrical parameters	U, I, P
Measurement of energy	kWh
DI	3DI
Temperature measurement	The inner temperature of power module

2.4 Wiring

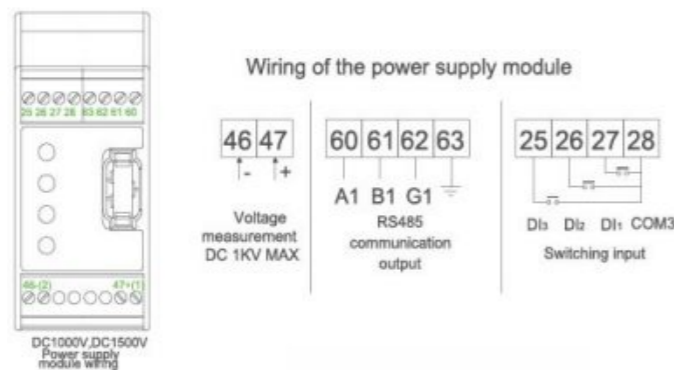

3. ACR10R-D Series PV/Solar Inverter Energy Meter

3.1 Model Description

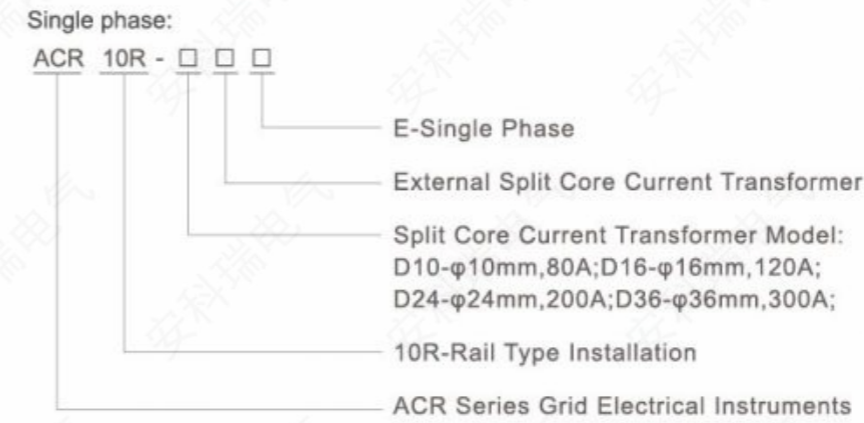

3.2 Technical Parameter

Single phase:

Technical Parameter		Indicators
Input	Grid	Single Phase
	Frequency	45~65Hz
	Voltage	Rated voltage: AC 100V,400V
		Overload: 1.2 times the rated voltage(continuous); 2 times the rated voltage lasting for 1 second
		Power consumption: less than 0.2VA
Current	Rated current: 10A, 20A, 40A, 80A, 120A, 200A etc. (for details see product specifications) Overload: 1.2 times the rated current(continuous);10 times the rated current lasting for 1 second	
	Power consumption: less than 0.2VA	
Output	Communication	RS485 interface, Modbus-RTU
	Display	LCD
Measurement precision	Voltage: 0.2 level; current, power Active energy: 0.5 level; 0.01Hz frequency; Reactive energy: 1 level	
Power supply	AC85~265V or DC100~350V; Consumption ≤10VA	
Safety	Power-frequency withstand voltage	AC2kV 1 min between power supply // current input // voltage input and communication
		AC2kV 1 min between each pair of combinations among power supply, current input and voltage input.
	Insulation resistance	Input,Output terminal to housing>100MΩ
Environment	Working temperature: -10℃~+55℃; Storage temperature: -20℃~+70℃	
	Relative humidity: 5%~95% No condensation; Altitude: ≤2000m	

Three phase

Technical Parameter		Value
Input	Net work	Three phase three wire- Three phase four wire
	Frequency	45~65Hz
	Voltage	Rated voltage: AC57.7V/100V(100V),220V/380V(400V)
		Overload: 1.2-fold rating(continuous);2-fold rating/1second
		Power consumption: less than 0.2VA
Current	Rated current: 80A, 120A, 200A .etc (See specific product specifications, special parameters can be customized)	
	Overload:1.2-fold rating(continuous);10-fold rating/1 second	
	Power consumption: less than 0.2VA	
Output	Electric Energy	Output mode:Open-collector photocoupler pulse,two way output
		Three phase Pulse constant:4000- 8000imp/kWh
	Communication	RS485 interface, Modbus-RTU
	Display	LCD

Technical Parameter		Value	
Function	Switch	Input	Four way dry contact input
		Output	Output mode: two way relay no contact output Contact capacity: AC 250V/3A- DC 30V/3A
Measuring accuracy		Frequency0.05Hz- reactive electric energy 1 class- other 0.5class	
Power supply		AC85~265V or DC100~350V; DC24V (±10%) ; DC48V (±10%) Consumption ≤10VA	
Safety	Power-frequency withstand voltage	Power frequency withstand voltage between Auxiliary power and switch volume output and current input and voltage input and communication and pulse output and switch volume input terminal is AC2kV 1min; Power frequency withstand voltage between auxiliary power and switch volume output and current input voltage input terminal is AC 2kV/1min; Power frequency withstand voltage between communication and pulse output and switch volume input terminal is AC 1kV/1min;	
		Insulation resistance	Input,Output terminal to housing>100MΩ
Environment	Working temperature: -10℃~+55℃; Storage temperature: -20℃~+70℃		
	Relative humidity: 5%~95% No condensation; Altitude: ≤2000m		

3.3 Product functions

Single phase:

Functional characteristic	model	ACR10R-DxxTE
Measuring parameters	Single-phase current	■
	Single-phase voltage	■
	Single-phase (active power, reactive power, power factor)	■
	Three-phase (active energy, reactive energy)	■

Note:1."■"refers to standard function, the standard configuration for above instruments is 1 channel RS485 communication.

Three phase

Functional characteristic	model	ACR10RH-DxxT(R)E4 ACR10RH-DxxT(R)E3
Display mode	LCD (Field LCD)	■
Measuring parameter	Current/voltage/frequency/power facto	■
	Active power/reactive power/apparent power	■
	Four quadrant electric energy measurement	■
	Maximum demand	□
	Multiple rate electric energy measurement	□
Power quality monitoring	Total harmonic content	■
	subharmonic (2-31 times)	■
Data logging	Incident record	□

Functional characteristic	model	ACR10RH-DxxT(R)E4 ACR10RH-DxxT(R)E3
Data logging	Alarm	□
	Built-in clock	□
communication	RS485 interface	■
Optional function (choose one)	J (2DO)	A1+ (B1 or C1) (4DI+2DO or 4DI+EP)*
	K (4DI)	
	pulse (2channels)	

Functional characteristic	model	ACR10R-DxxTE
Measuring parameter	Single-phase current	■
	Single-phase voltage	■
	Single-phase (active power, reactive power, power factor)	■
	Three-phase (active energy, reactive energy)	■

Note: 1. "■" is standard allocation function, "□" is matching function, Above instrument standard 1 channel RS485 communication;
 2. Terminal connection mode corresponding to A1/B1/C1 and so on in selection function;
 3. Pulse output and relay output can not be selected at the same time;
 4. When you select an event logging feature, you must configure the DI or DO feature.
 Note: 1. "■" refers to standard function, the standard configuration for above instruments is 1 channel RS485 communication.

3.4 Wiring

Single phase:

(Note: The connection diagram on the instrument housing shall prevail in case of any discrepancies with it)

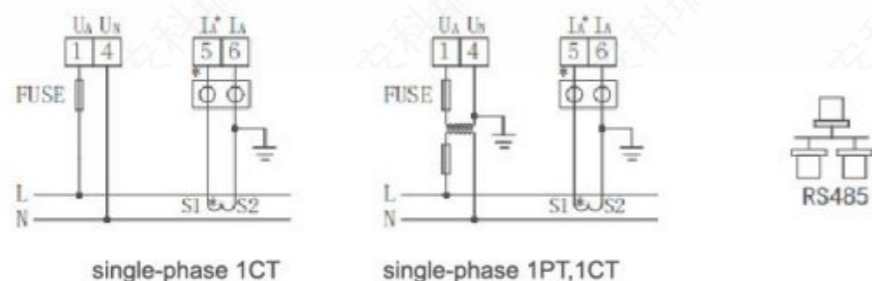

Tip: It is recommended to use 0.5A or 3A for the fuse in the connection diagram; RS485 communication terminal connection can use either RJ45 female or normal connector.

Three phase:

(Note: in case of any inconsistency with the wiring diagram on the meter housing, the wiring diagram on the meter housing shall prevail)

According to different design requirements, it is recommended to add fuses in the power supply and voltage input terminals to meet the safety requirements of relevant electrical codes

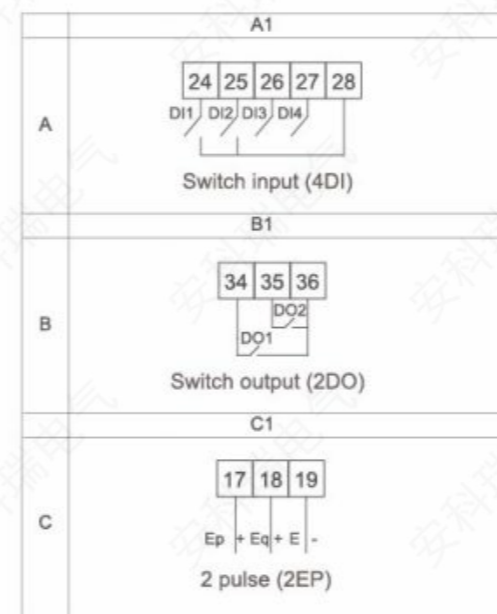
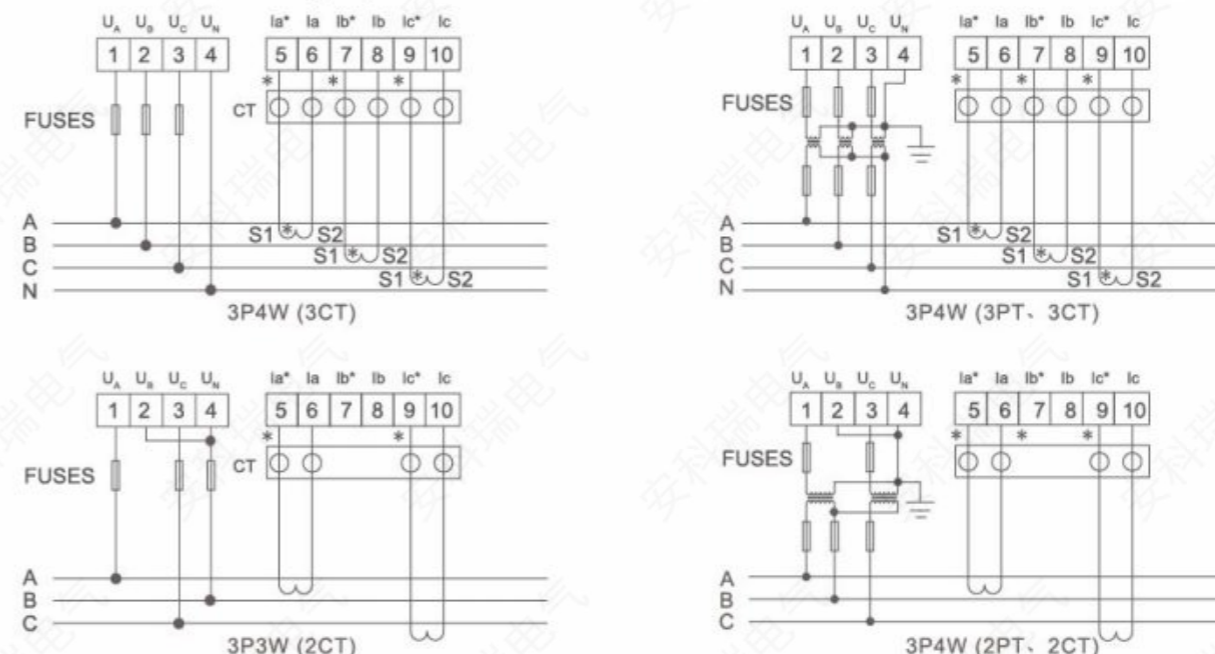

Tip: It is a test terminal for CT secondary; any side short connection.

When three-phase three-wire connection is made, no.2 terminal and no.4 terminal shall be externally connected together. The fuse in the wiring diagram is recommended 0.5A or 3A. When the instrument is installed on site, it must correspond to the supporting open and closed transformer or roche coil one by one, otherwise the measurement accuracy will be affected, and the connection between the two must be reliable.

Smart Gateway

1.AWT100 Series Wireless Communication Terminal

1.1 Model Description

AWT - □	4GHW	WIFIHW
	GPS	LW868
	CEHW	LW923
	POW	LoRaHW



1.2 Technical Parameter

Technical Parameter	Value
Operating voltage	12-24V DC
Operating current	250-400mA@12V
Size	96*67*24mm
2G/4G Work band	LTE-FDD: B1 B2 B3 B4 B5 B7 B8 B12 B13 B18 B19 B20 B25 B26 B28 LTE-TDD: B38 B39 B40 B41 UMTS: B1 B2 B4 B5 B6 B8 B19 GSM: B2 B3 B5 B8
LoRa/LoRaWAN Work band	868MHz,923MHz
Uplink	4G / CE / LORAWAN/ LoRa / GPS /WIFI
Downlink	RS485

1.3 Product Functions

Product type	Downlink	Uplink
AWT100-4GHW	RS485	4G
AWT100-CEHW	RS485	CE
AWT100-WIFIHW	RS485	WIFI
AWT100-LW868	RS485	LW868
AWT100-LW923	RS485	LW923
AWT100-LoRaHW	RS485	LoRa868
AWT100-GPS	RS485	GPS

Communication protocol:transparent transmission / MQTT(JSON) / MODBUS

1.4 Wiring

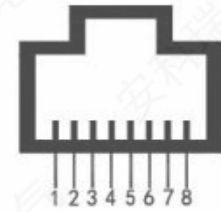
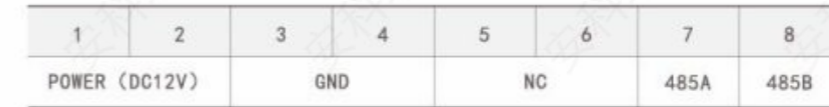
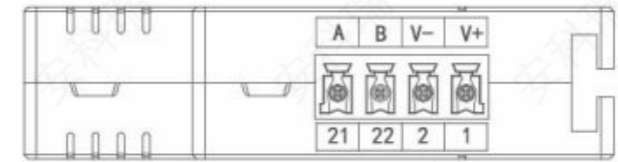
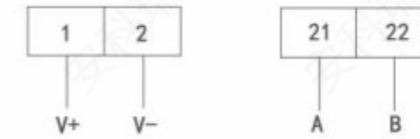
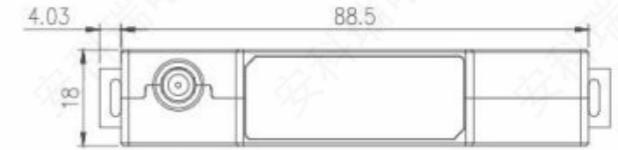
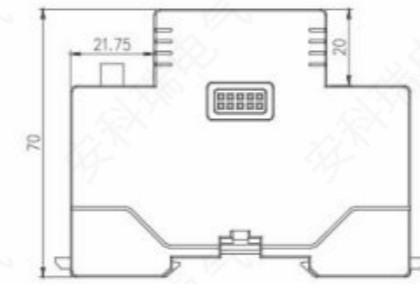

AWT100-POW:

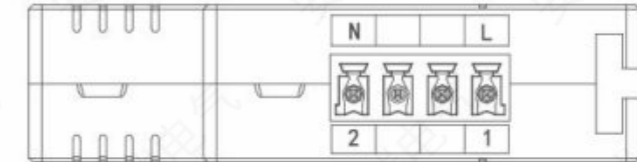
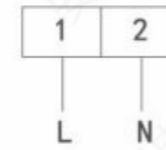

Auxiliary power supply (AC/DC220V)

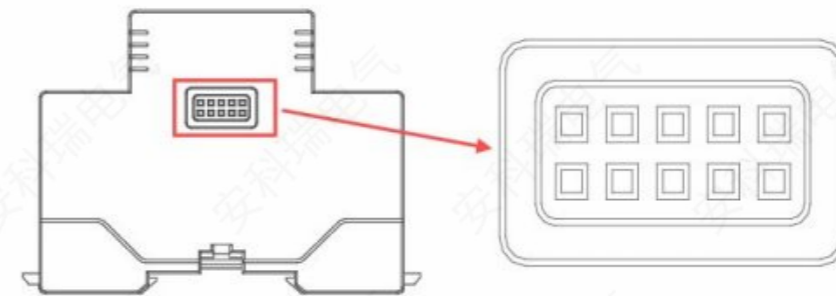

2.ANet Series Smart Gateway

2.1 ANet-1E1S1/1E2S1 Smart IoT Gateway

2.1.1 Model Description

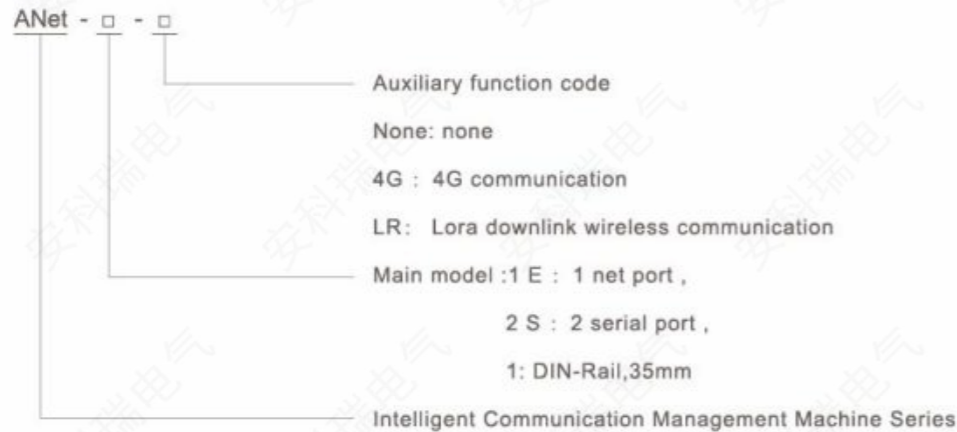

Note :1.4G function standard external SMA sucker antenna, standard line length 1.5 meters.

2.Lora function standard external sucker antenna, standard line length 2 meters.

2.1.2 Technical parameter

Model	ANet-1E1S1	ANet-1E1S1-LR	ANet-1E1S1-4G	ANet-1E1S1-4G/LR	ANet-1E2S1	ANet-1E2S1-LR	ANet-1E2S1-4G	ANet-1E2S1-4G/LR
Uplink	1 Ethernet	1 Ethernet	1 Ethernet, 4 G 1	1 Ethernet, 4 G 1	1 Ethernet	1 Ethernet	1 Ethernet, 4 G 1	1 Ethernet, 4 G 1
Down	1 RS485 Road	1 RS485 Road, 1 LORA Road	1 RS485 Road	1 RS485 Road, 1 LORA Road	2 RS485 Road	2 RS485 Road, 1 LORA Road	2RS485 Road	2 RS485 Road, 1 LORA Road
Lora wireless operating frequency	/	410MHz~525 MHz	/	410MHz~525 MHz	/	410MHz~525 MHz	/	410MHz~525 MHz
Power supply voltage	AC/DC 220V (85-265V)							
Frequency and Power Consumption	50Hz (45~65 Hz),10 W power consumption							
Security	Power frequency withstand voltage :1 min: 2kV (220V equipment) Insulation resistance :100 MΩ of input and output > to housing in general test atmosphere							
Environment	Operating temperature :-20℃~+55℃ Storage transport temperature :-25℃~+70 Relative humidity :≤95%(+25℃) Altitude :≤2500							
RS485 Serial	1-way coupling isolation				Two-way coupling isolation			
RJ45 network ports	10/100 M adaptive capacity							
2G/3G/4G	/	/	2G/3G/4G	2G/3G/4G	/	/	2G/3G/4G	2G/3G/4G

Model	ANet-1E1S1	ANet-1E1S1-LR	ANet-1E1S1-4G	ANet-1E1S1-4G/LR	ANet-1E2S1	ANet-1E2S1-LR	ANet-1E2S1-4G	ANet-1E2S1-4G/LR
Word band	LTE-FDD:B1 B2 B3 B4 B5 B7 B8 B12 B13 B18 B19 B20 B25 B26 B28 LTE-TDD:B38 B39 B40 B41 UMTS:B1 B2 B4 B5 B6 B8 B19 GSM:B2 B3 B5 B8							
Other interfaces	TF card standard slot, support storage extension, breakpoint continuation							
Electrical performance	IEC61000-4-2 ESD immunity test Class 4							
	Class 4 immunity test of IEC61000-4-4 fast transient pulse group							
	IEC61000-4-5 surge (shock) immunity test class 4							
Agreement support	IEC61000-4-6 radiation electromagnetic field interference test							
	GBT19582-2008 (Modbus、ModbusTCP)、DL/T645-1997、DL/T645-2007、CJT188-2004、IEC60870-5 (101、103、104)、MQTT、Support HTTP(s)、XML、Json forwarding format etc.							

2.2 ANet-2E4S1/2E8S1 Communications Management Machine

2.2.1 Model Description

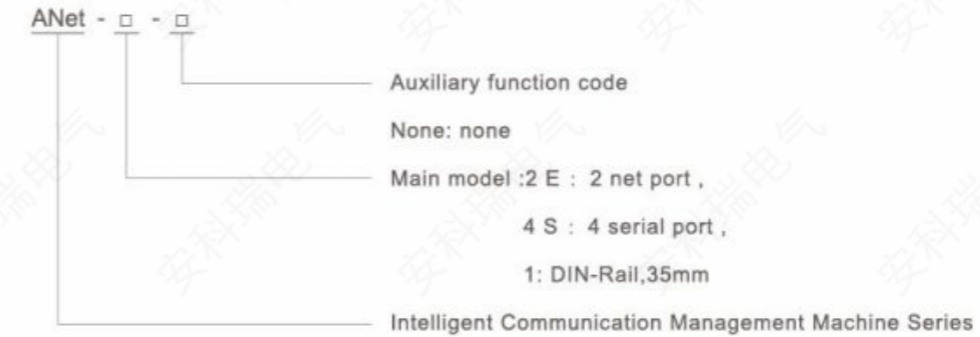

2.2.2 Technical Parameter

Model	ANet-2E4S1	ANet-2E8S1
Uplink	2 Ethernet communications	
Down	4 RS485 Communications	8 RS485 Communications
Power supply voltage	AC/DC 220V (85-265V)	
Frequency and Power Consumption	50Hz (45~65 Hz),10 W power consumption	
Security	Power frequency withstand voltage :1 min: 2kV (220V equipment) Insulation resistance :100 MΩ of input and output > to housing in general test atmosphere	
Environment	Operating temperature :-20℃~+55℃ Storage transport temperature :-25℃~+70 Relative humidity :≤95%(+25℃) Altitude :≤2500	
RS485 Serial	4-way coupling isolation	8 channels of optocoupler isolation
RJ45 network ports	2 paths 10/100 M Adaptive	
Other interfaces	RS232 management serial port +1* USB2.0+SD Card standard slot, support storage extension, breakpoint continuation	

Model	ANet-2E4S1	ANet-2E8S1
Electrical performance	GB/T17626.2-2018 ESD immunity test Class 4	
	GB/T17626.3-2016 RF electromagnetic field radiation immunity test level 3	
	Class 4 immunity test of GB/T17626.4-2018 fast transient pulse group	
	GB/T17626.5-2019 surge (shock) immunity test class 4	
Agreement support	GBT19582-2008 (Modbus、ModbusTCP)、DL/T645-1997、DL/T645-2007、CJT188-2004、IEC60870-5 (101、103、104)、MQTT、Support HTTP(s)、XML、Json forwarding format etc.	

2.3 ANet-2E4SM Modular communication management machines

2.3.1 Model Description

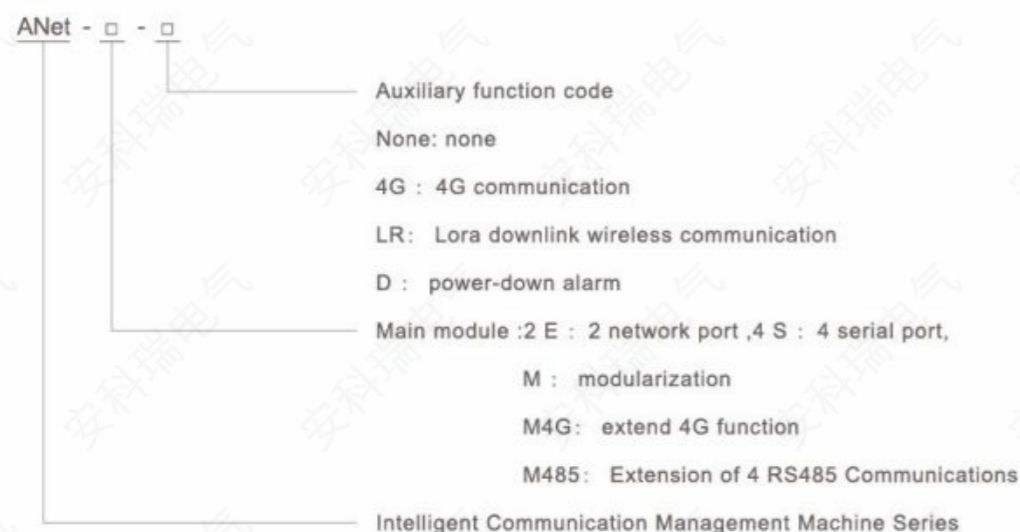

2.3.2 Technical Parameter

Main module technical specifications

Model	ANet-2E4SM	ANet-2E4SM-LR	ANet-2E4SM-D	ANet-2E4SM-LR/D
Uplink	2 Ethernet communications			
Down	4 RS485 Communications	4 RS485、1 LORA Communication	4 RS485 Communications	4 RS485、1 LORA Communication
Lora wireless operating frequency	/	410MHz~525 MHz	/	410MHz~525 MHz
Power supply voltage	DC 12V ~36 V			
Frequency and Power Consumption	50Hz (45~65 Hz),10 W power consumption			
Security	Power frequency withstand voltage: AC 2kV 1min between communication terminal and auxiliary power supply			
	Insulation resistance :100 MΩ> input and output to housing			

Model	ANet-2E4SM	ANet-2E4SM-LR	ANet-2E4SM-D	ANet-2E4SM-LR/D
Environment	Operating temperature :-20℃~+55℃ Storage transport temperature :-25℃~+70			
	Relative humidity :≤95%(+25℃) Altitude :≤2500			
Serial Interface	4-channel optocoupler isolation RS485+1-channel RS232(test port)			
Ethernet interface	2 paths 10/100 M Adaptive			
USB HOST	One-way USB2.0 high-speed interface, support access U disk for intermittent transmission or wireless WiFi network card (optional)			
TF card interface	Support for hot-plug and plug-and-play breakpoint continuation data storage			
DI acquisition	Input of 8-way passive dry contact switch			
RST key	Short press 2-5 seconds to restart the device, long press more than 5 seconds to restore factory default settings			
Power off alarm	/	/	Support power off to maintain working condition for more than 5 seconds, and send power off alarm	
Electrical performance	GB/T17626.2-2018 ESD immunity test Class 4			
	GB/T17626.3-2016 RF electromagnetic field radiation immunity test level 3			
	Class 4 immunity test of GB/T17626.4-2018 fast transient pulse group			
	GB/T17626.5-2019 surge (shock) immunity test class 4			
Agreement support	GBT19582-2008 (Modbus、ModbusTCP)、DL/T645-1997、DL/T645-2007、CJT188-2004、IEC60870-5 (101、103、104)、MQTT、Support HTTP(s)、XML、Json forwarding format etc.			

Optional module technical specifications

ANet-M485 module	Power supply	RJ45 interface, powered by main module
	Communications	Uplink: RJ45 interface, communication with main module Down :4-way optocoupler isolation RS485
ANet-M4G-HW module	Power supply	RJ45 interface, powered by main module
	Communications	Uplink :2G/3G/4G Word band:LTE-FDD:B1 B2 B3 B4 B5 B7 B8 B12 B13 B18 B19 B20 B25 B26 B28 LTE-TDD:B38 B39 B40 B41 UMTS:B1 B2 B4 B5 B6 B8 B19 GSM:B2 B3 B5 B8
		Downlink: RJ45 interface, communication with main module

Data Center/Tower/Base Station

1.AMC Series Data Center Monitor Module

1.1 AMC16Z-ZA Data Center Monitor Device



• Technical Parameter

Technical Parameter	Value	
Distribution System	AC	
Measurement of electrical parameters	A+B independent 2 channels three-phase inlet U,I,P,Q,S,PF,EP,EQ,UN to PG, neutral current 2-63rd harmonic of voltage and current 6 channels passive switch input 2 channels switch output RS485(Modbus-RTU) communication.	
Voltage	Nominal	220VAC
	Range	±20%
	Overload	2times lasting 1 second(instantaneous)
Current	CT	XXA/5A
	Range	0~120%
	Overload	1.2 times(continuous), 10 times lasting 1 second(instantaneous)
Input frequency	45~65Hz	
Accuracy	Class 0.2(U/I) Class 0.5(P/EP) Class 1(Q/EQ)	
Insulation resistance	100MΩ	
Switch output	2 channels (3A 250VAC/ 3A 30VDC)	
Switch input	6 channels	
Communication	RS485(Modbus-RTU)	
Installation	DIN 35mm	

• Wiring

Terminal No.	Definition	Description	Remark
1	V+	Voltage output	DC 12V
2	V-		
4	IA+	Phase-A current	Three-phase current input of channel A
5	IA-		
6	IB+		
7	IB-		
8	IC+	Phase-C current	
9	IC-		
10	UN	AC voltage null line	Three-phase voltage input of channel A
11	UA	Phase-A AC voltage	
12	UB	Phase-B AC voltage	

Terminal No.	Definition	Description	Remark
13	UC	Phase-C AC voltage	Three-phase voltage input of channel A
	PG	Ground	
14	IA+	Phase-A current	Three-phase current input of channel B
15	IA-		
16	IB+	Phase-B current	
17	IB-		
18	IC+	Phase-C current	
19	IC-		
20	UN	AC voltage null line	Three-phase voltage input of channel B
21	UA	Phase-A AC voltage	
22	UB	Phase-B AC voltage	
23	UC	Phase-C AC voltage	
	PG	Ground	
30	A	RS485(Modbus-RTU)	Connect to HMI or RS485 hub
31	B		
50	DO1	Switch output	Connect buzzer
51			
52	DO2		Connect indicator light
53			
61	Inlet A	Switch input	OF
62			SD
63	Lightning protection A		Lightning protector A
64	Inlet B		OF
65			SD
66	Lighting protection B		Lighting protector B
69	Common port	Switch common port	
71	I1	Leakage current	Channel 1 leakage current
72	I2		Channel 2 leakage current
79	COM		Leakage current common port
81	V-	Temperature&Humidity	Connect WH-3 temperature and humidity sensor
82	DATE		
83	CLK		
84	V+		

1.2 AMC16MA Data Center Monitor Device



• Technical Parameter

Technical Parameter	Value
Distribution System	AC
Measurement of electrical parameters	Three-phase 2 channels inlet I,U,P,Q,EP,EQ,S Single-phase 36 channels outlet (Three-phase 12 channels outlet) I,U,P,Q,EP,EQ

Technical Parameter		Value	
Busbar voltage	Rated voltage	220V AC	
	Range	40~400V AC	
	Overload	1.2 times(continuous), 10 times lasting 1 second(instantaneous)	
Current	Inlet	CT	XXA/5A
		Range	0~10A
	Outlet	CT	100A/20mA
		Range	0~120%
	Overload	1.2 times for continuous, and 10 times/5 seconds for instantaneous	
Frequency	45~65Hz		
Accuracy	Inlet	Class 1.0	
	Outlet	Class2.0	
Auxiliary power supply	AC85-265V/DC100-350V		
Insulation resistance	100MΩ		
Environment	Temperature	Operation:-10℃~45℃ Storage:-25℃~70℃	
	Humidity	Relative humidity≤95%	
	Altitude	≤2000m	
Switch output	5A 250VAC/5A 30VDC		
Communication	RS485(Modbus-RTU)		
Installation	DIN 35mm		

• Wiring

Terminal No.	Definition	Description	Remark
1	L	AC power supply input	AC220V
2	N		
4	IA1*	Phase-A 1 current	AC direct grounding
5	IA1		
6	IB1*	Phase-B 1 current	AC direct grounding
7	IB1		
8	IC1*	Phase-C 1 current	AC direct grounding
9	IC1		
10	UN	AC voltage null line	
11	UA	Phase-A AC voltage	Splicing with 11 in single-phase
12	UB	Phase-B AC voltage	Splicing with 11 in single-phase
13	UC	Phase-C AC voltage	Splicing with 11 in single-phase
14	IA2*	Phase-A 2 current	AC direct grounding
15	IA2		
16	IB2*	Phase-B 2 current	AC direct grounding supply grounding
17	IB2		
18	IC2*	Phase-C 2 current	AC direct grounding
19	IC2		
21	+	Power supply	DC48V
22	-		

Terminal No.	Definition	Description	Remark
30	A1	1* RS485(Modbus-RTU)	
31	B1		
40	A2		
41	B2	2* RS485(Modbus-RTU)	
50			
51		Switch output	
I1~I36	+	Outlet current	
	-		
Addr1	Address 1	Setting method is given in device panel in detail	
Addr2	Address 2		
Baud1	Baud rate 1		
Baud2	Baud rate 2		

▶ 1.3 AMC16Z-FAK48 Data Center Monitor Device

• Technical Parameter



Technical Parameter		Value
Distribution System		AC
Measurement of electrical parameters		I,U,P,Q,EP,EQ,S
		2-3rd harmonic
		24 channels on each side (48 in total)
		48DI
Current	CT	XXA/50mA
	Range	0~120%
	Overload	1.2 times for continuous, and 10 times/second for instantaneous
Frequency	45~65Hz	
Accuracy	Class 0.2(U/I) Class 0.5(P/EP) Class 1(Q/EQ)	
Auxiliary power supply	DC12V	
Insulation resistance	100MΩ	
Environment	Temperature	Operation:-10℃~45℃ Storage:-25℃~70℃
	Humidity	Relative humidity≤95%
	Altitude	≤2000m
Communication	RS485(Modbus-RTU)	
Installation	DIN 35mm	
Switch input	48DI	

• Wiring

Terminal No.	Definition	Description
V+	Auxiliary power supply	Power supply by AMC16Z-ZA
V-		
A	RS485 communication	Connect to HMI
B		
A1	Side-A Current 1	Side A current input
A2	Side-A Current 2	
A3	Side-A Current 3	
GA1	Common port of A-channel current negative pole	Side A current input
A4	Side-A Current 4	
A5	Side-A Current 5	
A6	Side-A Current 6	Side A current input
GA2	Common port of A-channel current negative pole	
A7	Side-A Current 7	
A8	Side-A Current 8	Side A current input
A9	Side-A Current 9	
GA3	Common port of A-channel current negative pole	
A10	Side-A Current 10	Side A current input
A11	Side-A Current 11	
A12	Side-A Current 12	
GA3	Common port of A-channel current negative pole	Side A current input
A13	Side-A Current 13	
A14	Side-A Current 14	
A15	Side-A Current 15	Side A current input
GA5	Common port of A-channel current negative pole	
A16	Side-A Current 16	
A17	Side-A Current 17	Side A current input
A18	Side-A Current 18	
GA6	Common port of A-channel current negative pole	
A19	Side-A Current 19	Side A current input
A20	Side-A Current 20	
A21	Side-A Current 21	
GA7	Common port of A-channel current negative pole	Side A current input
A22	Side-A Current 22	
A23	Side-A Current 23	
A24	Side-A Current 24	Side A current input
GA8	Common port of A-channel current negative pole	

Terminal No.	Definition	Description
B1	Side-B Current 1	Side B current input
B2	Side-B Current 2	
B3	Side-B Current 3	
GB1	Common port of B-channel current negative pole	Side B current input
B4	Side-B Current 4	
B5	Side-B Current 5	
B6	Side-B Current 6	Side B current input
GB2	Common port of B-channel current negative pole	
B7	Side-B Current 7	
B8	Side-B Current 8	Side B current input
B9	Side-B Current 9	
GB3	Common port of B-channel current negative pole	
B10	Side-B Current 10	Side B current input
B11	Side-B Current 11	
B12	Side-B Current 12	
GB4	Common port of B-channel current negative pole	Side B current input
B13	Side-B Current 13	
B14	Side-B Current 14	
B15	Side-B Current 15	Side B current input
GB5	Common port of B-channel current negative pole	
B16	Side-B Current 16	
B17	Side-B Current 17	Side B current input
B18	Side-B Current 18	
GB6	Common port of B-channel current negative pole	
B19	Side-B Current 19	Side B current input
B20	Side-B Current 20	
B21	Side-B Current 21	
GB7	Common port of B-channel current negative pole	Side B current input
B22	Side-B Current 22	
B23	Side-B Current 23	
B24	Side-B Current 24	Side B current input
GB8	Common port of B-channel current negative pole	
KA1	Side-A AC Voltage 1	
KA2	Side-A AC Voltage 2	
KA3	Side-A AC Voltage 3	
KA4	Side-A AC Voltage 4	
KA5	Side-A AC Voltage 5	
KA6	Side-A AC Voltage 6	

Terminal No.	Definition	Description
KA7	Side-A AC Voltage 7	Side A switch input
KA8	Side-A AC Voltage 8	
KA9	Side-A AC Voltage 9	
KA10	Side-A AC Voltage 10	
KA11	Side-A AC Voltage 11	
KA12	Side-A AC Voltage 12	
UNA	Side-A AC Voltage Null Line	
KA13	Side-A AC Voltage 13	
KA14	Side-A AC Voltage 14	
KA15	Side-A AC Voltage 15	
KA16	Side-A AC Voltage 16	
KA17	Side-A AC Voltage 17	Side A switch input
KA18	Side-A AC Voltage 18	
KA19	Side-A AC Voltage 19	
KA20	Side-A AC Voltage 20	
KA21	Side-A AC Voltage 21	
KA22	Side-A AC Voltage 22	
KA23	Side-A AC Voltage 23	
KA24	Side-A AC Voltage 24	
KB1	Side-B AC Voltage 1	Side B switch input
KB2	Side-B AC Voltage 2	
KB3	Side-B AC Voltage 3	
KB4	Side-B AC Voltage 4	
KB5	Side-B AC Voltage 5	
KB6	Side-B AC Voltage 6	
KB7	Side-B AC Voltage 7	
KB8	Side-B AC Voltage 8	
KB9	Side-B AC Voltage 9	
KB10	Side-B AC Voltage 10	
KB11	Side-B AC Voltage 11	
KB12	Side-B AC Voltage 12	
UNB	Side-B AC Voltage Null Line	
KB13	Side-B AC Voltage 13	Side B switch input
KB14	Side-B AC Voltage 14	
KB15	Side-B AC Voltage 15	
KB16	Side-B AC Voltage 16	
KB17	Side-B AC Voltage 17	
KB18	Side-B AC Voltage 18	
KB19	Side-B AC Voltage 19	
KB20	Side-B AC Voltage 20	
KB21	Side-B AC Voltage 21	
KB22	Side-B AC Voltage 22	
KB23	Side-B AC Voltage 23	
KB24	Side-B AC Voltage 24	

1.4 AMC16Z-ZD Data Center Monitor Device

• Technical Parameter



Technical Parameter		AMC16Z-ZD
Measured parameters		Voltage,current,power,electric energy,ambient temperature and humidity
Bus voltage	Rated	48VDC,240VDC,336VDC
	Measuredrange	±20%
	Overload	Instantaneous voltage 2 times per second
Current incoming line circuit	Rated	5V (Hall sensor,powered by AMC16Z-ZD ±12V)
	Overload	Duration 1.2 times,instantaneous 10 times/second
Temperature and humidity	Temperaturerange	-40℃~+99℃
	Humidity range	20%-90%
Measurement precision	Incoming line	Voltage/current Class 0.5,power/electric energy Class 1
	Temperature	±1℃
	Humidity	±5%
Auxiliary power		Signal take electricity(≤15W)
Environment	Temperature	Work: -10℃ ~ 45℃ Storage: -25℃ ~ 70℃
	Humidity	Relative humidity ≤95%
	Altitude	≤2000m
Switching output		2 way 3A 250VAC /3A 30VDC
Switching input		6 way dry contact
Communication		RS485/Modbus-RTU
Installation		DIN35mm guide rail or floor mounted
Protection grade		IP20
Pollution levels		2
Security	Insulation	All terminals and the insulation resistance between the conductive pieces not below 100 MΩ
	Pressure	A circuit voltage and current signal // B circuit voltage and current signal // Switching output // other ports should meet AC2kV 1min between pairs,switching input and other ports should meet AC0.5kV 1min,leakage currentshould be less than 2mA,no breakdown or flash over phenomenon.
Electromagnetic compatibility	Antistaticinterference	Class 4
	Resistance to rapid transient pulse groups	Class 3
	Resistantto surge interference	Class 4
	Radio frequency electromagnetic radiation	Class 3

• Wiring



Terminal No.	Definition	Explanation	Description
1	V+	Power Output	The power supply for AMC16Z-FD, AMC16Z-FDK24, AMC16Z-FDK48, AMC16Z-KA, AMC16Z-KD and touch screen. The power supply is not allowed to be connected to other devices (such as indicator light and buzzer)
2	V-		
4	IA+	A-way current input	A-way incoming line DC current (Hall sensor input)
5	IA-		
6	IB+	B-way current input	B-way incoming line DC current (Hall sensor input)
7	IB-		
10	UA+	A-way voltage input	A-way incoming DC voltage input
11	UA-		
12	UB+	B-way voltage input	B-way incoming DC voltage input
13	UB-		
30	A	RS485 communication	Connect to touch screen or RS485 hub
31	B		
50	DO1	Switching output	Buzzer
51	DO1		
52	DO2		
61	Incoming line A	Switching Input	OF+SD
62			SD
63	Lightning protection A		Judge A-way lightning protector state
64	Incoming line B		OF+SD
65			SD
69	Public end		
81	VSS	Temperature and humidity	Connect WH-3 temperature and humidity sensor
82	DATA		
83	CLK		
84	VDD		
91	+12V	A-way Hall power supply	Power supply to the A incoming line is matched with hall
93	-12V		
94	+12V	B-way Hall power supply	Power supply to the B incoming line is matched with hall
96	-12V		

➤ 1.5 AMC16Z-FDK48 Data Center Monitor Device

• Technical Parameter



Instrument model	AMC16Z-FDK48	
Measured parameter	Voltage, current, power, electrical energy, switching state	
Bus voltage	Rated	48VDC, 240VDC, 336VDC
	Measured range	±20%
	Overload	Instantaneous voltage 2 times per second
Current outgoing line circuit	Rated	5V (Hall sensor, external power supply ±12V)
	Range	
	Overload	Duration 1.2 times, instantaneous 10 times/second
Measurement precision	Outgoing line	Voltage/current level 0.5, power/electric energy level 1
Auxiliary power	Get power supply from AMC16Z-ZD; DC 12-24V when used alone	
Environment	Temperature	Work: -10°C ~ 45°C Storage: -25°C ~ 70°C
	Humidity	Relative humidity ≤95%
	Altitude	≤2000m
Communication	RS485/Modbus-RTU	
Installation	DIN35mm guide rail or floor mounted	
Protection level	IP20	
Pollution levels	2	
Security	Insulation	All terminals and the insulation resistance between the conductive pieces not below 100 MΩ
	Pressure	A voltage current signal // B voltage current signal // Other ports meet AC2kV 1min between pairs, leakage current should be less than 2mA, no breakdown or flashing phenomenon.
Electromagnetic compatibility	Anti-static interference	Class 4
	Radio frequency electromagnetic radiation	Class 3

• Wiring



Terminal No.	Explanation	Description
V+	Auxiliary power	Get power from AMC16Z-ZD or powered by DC12-24V
V-		
A	RS485 communication	Connect to touch screen or RS485 hub
B		
UA1-UA24	A-way voltage input	A-way switch input
UNA		
UB1-UB24	B-way voltage input	B-way switch input
UNB		
A1-A24	A-way current input	A-way outgoing line DC current input(24-way Hall sensor)
GA		
B1-B24	B-way current input	B-way outgoing line DC current input(24-way Hall sensor)
GB		

➤ 1.6 AMC16Z-KD Data Center Monitor Device

• Technical Parameter



Technical parameters	AMC16Z-KD	
Input frequency	45-60HZ	
Auxiliary power	Get power supply from AMC16Z-ZD;DC 12-24V when used alone	
Insulation Resistance	100MΩ	
Environment	Temperature	Work: -10℃ ~ 45℃ Storage: -25℃ ~ 70℃
	Humidity	Relative humidity ≤95%
	Altitude	≤2000m
Switching input	48-way dry contact	

Technical parameters	AMC16Z-KD	
Communication	RS485/Modbus-RTU	
Installation	DIN35mm guide rail or wall mounted installation	
Protection level	IP20	
Pollution levels	2	
Pressure	Insulation	All terminals and the insulation resistance between the conductive pieces not below 100 M Ω
	Pressure	The input signal of a-channel switching quantity // B-channel switching quantity input signal // other ports should meet AC2kV 1min between pairs,the leakage current should be less than 2mA,and there is no breakdown or flashing phenomenon.
Electromagnetic compatibility	Anti-static interference	Class 4
	Radio frequency electromagnetic radiation	Class 3

• Wiring



TerminalNo.	Definition	Explanation	Remarks
1	V+	Auxiliary power	Get power from AMC16Z-ZDor powered by DC12-24V
2	V-		
30	A	RS485 communication	Connect to touch screen or RS485 hub
31	B		
KA1-KA24		A-way switch input	A-way passive switching input (24 ways)
COMA			
KB1-KB24		B-way switch input	B-way passive switching input (24 ways)
COMB			

➤ 1.7 Touch Screen



7 inch touch screen appearance and installation: ATP007kt

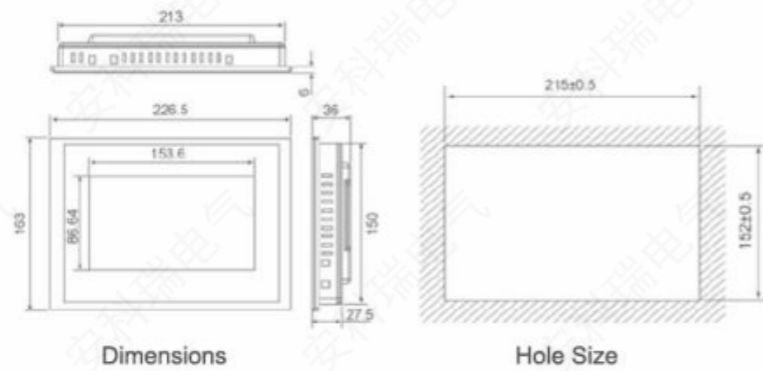

10 inch touch screen appearance and installation: ATP010kt

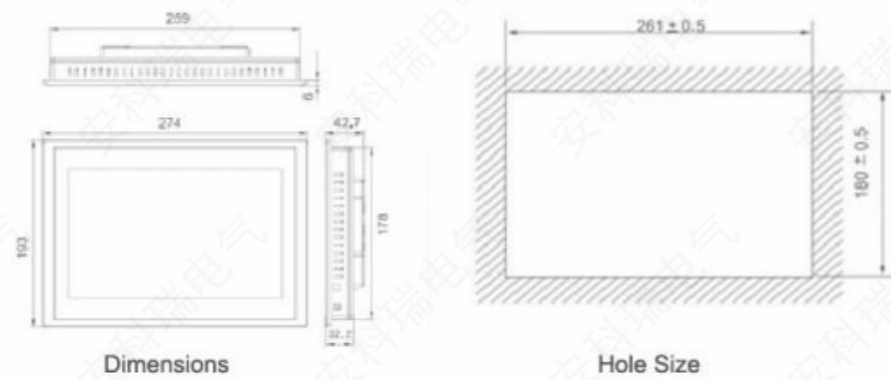

• touch screen interface description

Serial port (DB9) pin definition

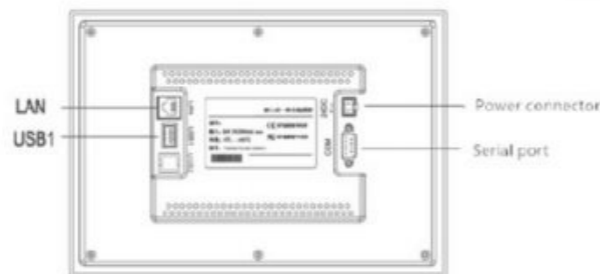

Serial port (DB9)	2 × RS485
USB1	Main port, compatible with USB2.0 standard
LAN (RJ45)	Ethernet interface
Power connector	24V DC ±20%

Serial port pin definition



Serial port pin definition

interface	PIN	pin definition
COM1	2	RS232 RXD
	3	RS232 TXD
	5	GND
COM2	7	RS485 +
	8	RS485 -
COM3	4	RS485 +
	9	RS485 -

• Installation

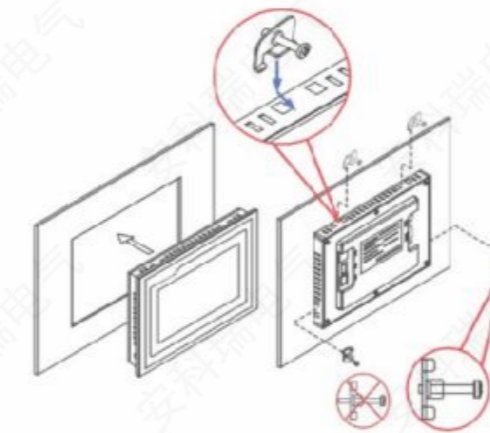

• Wiring
Power wiring

Step 1: Strip the 24V power cord and insert it into the power plug terminal

Step 2: Use a flat-blade screwdriver to tighten the power plug screws

Step 3: Insert the power plug into the power socket of the product

schematic diagram and pin definition of the power plug are as follows



PIN	definition
1	+
2	-



Communication wiring

There is a patch cord in the factory configuration, among which the red and blue (7-8) are downstream, which are connected to the 485 of the module, and the green and white (4-9) are upstream, and are used for rotating the ring.

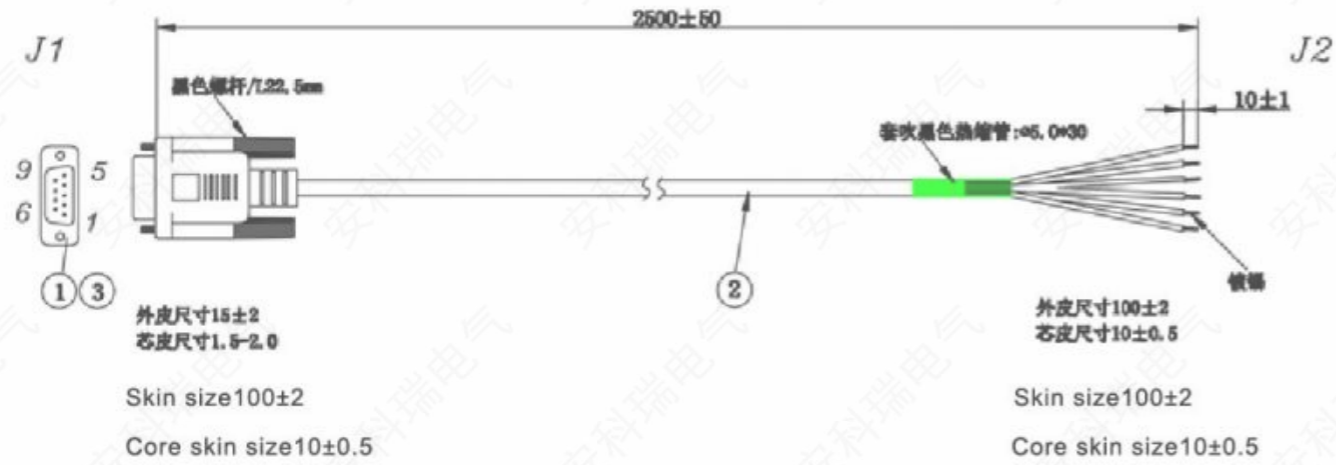

Green	4	RS485+
White	9	RS485-
Red	7	RS485+
Blue	8	RS485-

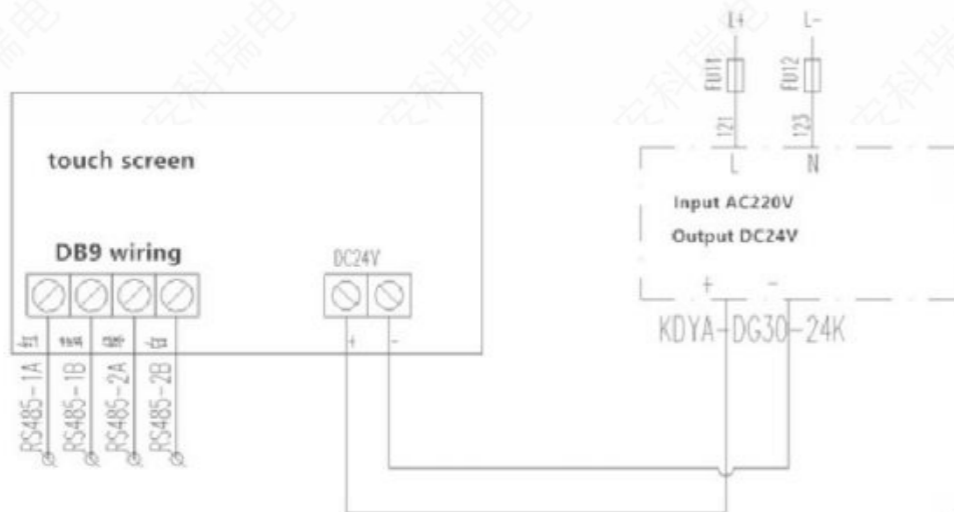

1.8 AMC100-ZA Data Center Monitor Device

Technical Parameter



Instrument model	AMC100-ZA		
Measurement parameters	Voltage, current, frequency, active power, reactive power, power factor, active energy, reactive energy, Zero-to-ground voltage, leakage current and zero sequence current, total harmonic content (THD), 2-63 harmonics, current and voltage unbalance, ambient temperature and humidity		
Bus voltage	Rated	220VAC	
	Measuring range	±20%	
	Overload	Instantaneous voltage 2 times/sec	
Current incoming circuit	Rated	Secondary 5A	
	Range	0~6A	
	Overload	Continuous 1.2 times, instantaneous 10 times/sec	
Temperature and humidity	Temperature Range	-40 C ~ +99 C	
	Humidity Range	20% ~ 90%	
Input frequency	AC45 ~ 65Hz		
Measurement accuracy	Incoming line	Voltage/current level 0.2, active power/energy level 0.5, reactive power/energy level 1	
	Temperature	±1 C	
	Humidity	±5%	
Auxiliary power	AMC100-ZA: signal to take power (≤15W)		
	AMC100-ZA-P220: 220V independent power supply		
	AMC100-ZA-P24: 24V independent power supply		
Environment	Temperature	Work: -10 C ~ 45 C Storage: -25 C ~ 70 C	
	Humidity	Relative humidity ≤ 95%	
	elevation	≤ 2000m	
Switch output	4 channels 3A 250VAC/3A 30VDC		
Switch input	8 dry nodes		
Communication	1 isolated RS485/Modbus-RTU to the background system		
	1 RS485/Modbus-RTU to touch screen		
	1 RS485/Modbus-RTU connection downstream module		
	Optional 1-channel Ethernet communication function		
Installation Method	DIN35mm rail or bottom plate installation		
Protection level	IP20		
Pollution level	2		
Security	Insulation	The insulation resistance between all terminals and the conductive parts of the shell is not less than 100MΩ	

Instrument model		AMC100-ZA
Security	Withstand voltage	A voltage and current signal//B voltage and current signal//switch output//isolated communication port//between other ports meet AC2kV 1min, switch input and other ports should meet AC0.5kV 1min, leakage current Should be less than 2mA, no breakdown or flashover phenomenon.
Bus voltage	Anti-static interference	Level 4
	Anti-electric fast transient burst	Level 3
Electromagnetic compatibility	Anti-surge interference	Level 4
	Resistance to radio frequency electromagnetic field radiation	Level 3

• Wiring

AMC100-ZA/CE-P220



AMC100-ZA/CE-P24

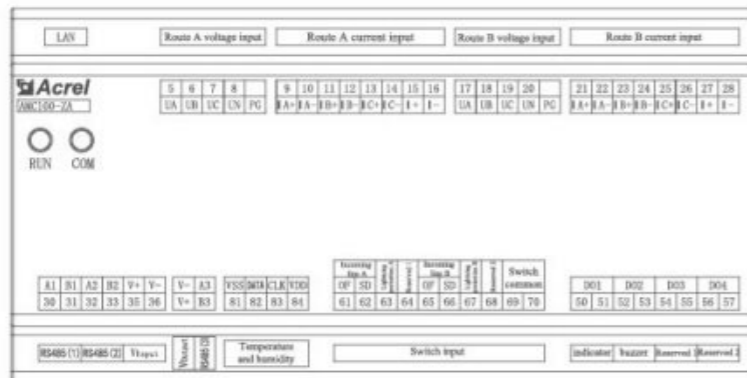

Terminal No.	Definition	Description	Description
1	L(+)	Auxiliary power	P220 used, not connected by default
2	N(-)		
5	UA	AC voltage Phase A	Three-phase voltage input of circuit A incoming line
6	UB	AC voltage Phase B	
7	UC	AC voltage Phase C	
8	UN	AC voltage neutral line	
PG		Ground	
9	IA+	Current input phase A	Three-phase current input of circuit A incoming line
10	IA-	Current input phase B	
11	IB+		
12	IB-		
13	IC+	Current input phase C	
14	IC-		
15	I+	A channel leakage current input	
16	I-		
17	UA	AC voltage Phase A	Three-phase voltage input of circuit B incoming line
18	UB	AC voltage Phase B	
19	UC	AC voltage Phase C	
20	UN	voltage neutral line	
PG		Ground	
21	IA+	Current input phase A	Three-phase current input of circuit B incoming line
22	IA-	Current input phase B	
23	IB+		
24	IB-		
25	IC+	Current input phase C	
26	IC-		
27	I+	B channel leakage current input	
28	I-		
30	A1	RS485(1)	The first isolated communication interface, connected to the background system
31	B1		
32	A2	RS485(2)	The second channel is connected to the touch screen or RS485 hub
33	B2		
	A3	RS485(3)	The third way is connected to the downstream module
	B3		
	LAN	Ethernet	CE with Ethernet communication
35	V+	Power Output (auxiliary power input when use p24)	Power supply to AMC100-FA30/48, AMC100-FAK30/48, AMC100-KA30/48, AMC100-KD30/48, AMC100-FT30/FT48 and touch screen, this power supply prohibits external external devices (such as indicator lights, buzzers
36	V-		
50	DO1	Switch output	Connect the buzzer
51	DO2		Connection indicator
52	DO3		Reserved 1
53			
54			
55			

Terminal No.	Definition	Description	Description
56	DO4	Switch output	Reserved 2
57			
61	Incoming line A	Switch input	OF
62			SD
63	Lightning protection A		Determine the SPD status of route A
64	Reserve		Reserved 1
65	Incoming line B	Switch input	OF+SD
66			SD
67	Lightning protection B		Determine the SPD status of route B
68	Reserve		Reserved 2
69	Common port	Switch input	Switch common
70			
81	VSS	Temperature and humidity	Connect WH-3 temperature and humidity sensor
82	DATA		
83	CLK		
84	VDD		

Instrument model	AMC100-FA30	AMC100-FA48
Protection level	IP20	
Pollution level	2	
Security	Insulation	The insulation resistance between all terminals and the conductive parts of the shell is not less than 100MΩ
	Withstand voltage	The voltage and current signals of circuit A//the voltage and current signals of circuit B//other ports meet AC2kV for 1min, the leakage current should be less than 2mA, and there is no breakdown or flashover.
	Anti-static interference	Level 4
Electromagnetic compatibility	Resistance to radio frequency electromagnetic field radiation	Level 3

1.9 AMC100-FA30/AMC100-FA48 Data Center Monitor Device

Technical Parameter



Instrument model	AMC100-FA30	AMC100-FA48
Measurement parameters	Voltage, current, frequency, active power, reactive power, power factor, active energy, reactive energy, 2-31 times total current harmonic content	
Bus voltage	Rated	220VAC
	Measuring range	±20%
	Overload	Instantaneous voltage 2 times/sec
Current outlet loop	Rated	50mA
	Range	0.125~60mA
	Overload	Continuous 1.2 times, instantaneous 10 times/sec
Input frequency	AC45~65Hz	
Measure	Outlet	Voltage/current/active power/active energy level 0.5, reactive power/reactive energy level 1
Auxiliary power	Powered by AMC100-ZA; DC 12-24V when used alone	
Environment	Temperature	Work: -10℃~45℃ Storage: -25℃~70℃
	Humidity	Relative humidity≤95%
	elevation	≤2000m
Communication	RS485/Modbus-RTU	
Installation Method	DIN35mm rail or bottom plate installation	

Wiring

AMC100-FA30

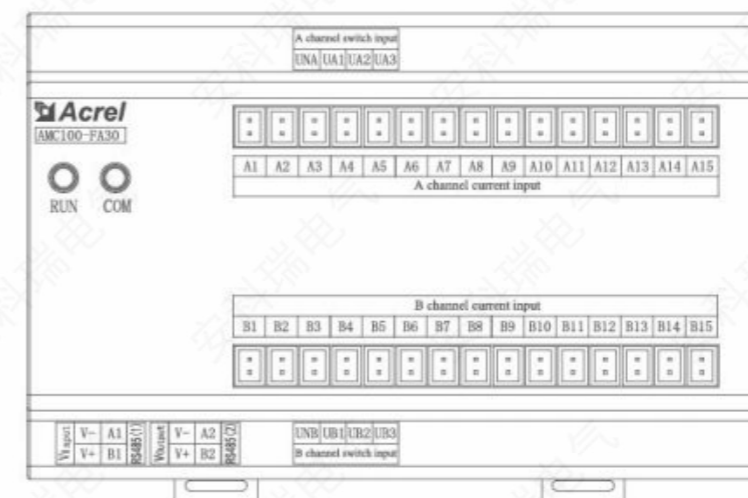

Definition	Illustrate	Remark
V+	Auxiliary power	Powered by AMC100-ZA Or powered by DC12-24V power supply
V-		
A1	RS485(1)	Connect the pre-module
B1		
A2	RS485(2)	Connect the subsequent sub-module
B2		
UNA	Route A voltage input	Three-phase voltage input of circuit A outgoing line
UA1		
UA2		
UA3	Route B voltage input	Three-phase voltage input of circuit B outgoing line
UNB		
UB1		
UB2	Route A current input	circuit A outgoing lineAC current input(15 channels)
UB3		
A1-A15	Route B current input	circuit A outgoing lineAC current input(15 channels)
B1-B15		

AMC100-FA48

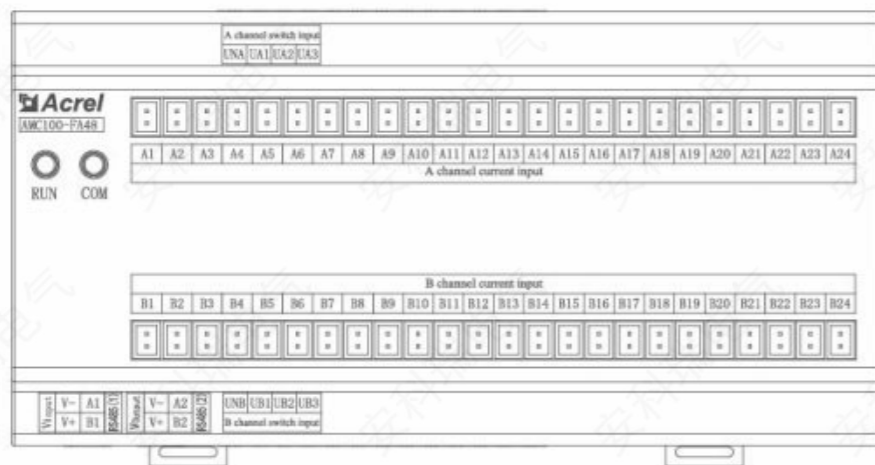

Definition	Illustrate	Remark
V+	Auxiliary power	Powered by AMC100-ZA Or powered by DC12-24V power supply
V-		
A1	RS485(1)	Connect the pre-module
B1	RS485(2)	Connect the subsequent sub-module
A2		
B2		
UA+	Route A voltage input	Three-phase voltage input of circuit A outgoing line
UA-		
UB+	Route B voltage input	Three-phase voltage input of circuit B outgoing line
UB-		
A1-A24	Route A current input	circuit A outgoing line AC current input(24 channels)
B1-B24	Route B current input	circuit B outgoing line AC current input(24 channels)

➤ 1.10 AMC100-FAK30/FAK48 Data Center Monitor Device

• Technical Parameter



Instrument model		AMC100-FAK30	AMC100-FAK48
Measurement parameters		Voltage, current, frequency, active power, reactive power, power factor, active energy, reactive energy, 2-31 times total current harmonic content	
Bus voltage	Rated	220VAC	
	Measuring range	±20%	
	Overload	Instantaneous voltage 2 times/sec	

Instrument model		AMC100-FA30	AMC100-FA48
Current outlet loop	Rated	50mA	
	Range	0.125~60mA	
	Overload	Continuous 1.2 times, instantaneous 10 times/sec	
Input frequency		AC45~65Hz	
Measure	Outlet	Voltage/current/active power/active energy level 0.5, reactive power/reactive energy level 1	
Auxiliary power		Powered by AMC100-ZA; DC 12-24V when used alone	
Environment	Temperature	Work: -15°C~55°C Storage: -25°C~70°C	
	Humidity	Relative humidity≤93%	
	elevation	≤2500m	
Communication		RS485/Modbus-RTU	
Installation Method		DIN35mm rail or bottom plate installation	
Protection level		IP20	
Pollution level		2	
Security	Insulation	The insulation resistance between all terminals and the conductive parts of the shell is not less than 100MΩ	
	Withstand voltage	The voltage and current signals of circuit A/the voltage and current signals of circuit B/other ports meet AC2kV for 1min, the leakage current should be less than 2mA, and there is no breakdown or flashover.	
	Anti-static interference	Level 4	
Electromagnetic compatibility	Resistance to radio frequency electromagnetic field radiation	Level 3	

• Wiring

AMC100-FAK30

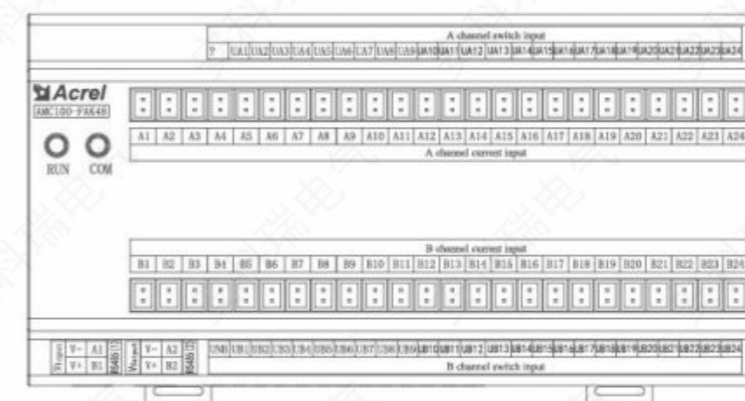

Definition	Illustrate	Remark
V+	Auxiliary power	Powered by AMC100-ZA Or powered by DC12-24V power supply
V-		
A1	RS485(1)	Connect the pre-module
B1		
A2	RS485(2)	Connect the subsequent sub-module
B2		
UA1-UA15	Route A voltage input	Route A switch input (15 channels)
UNA		
UB1-UB15	Route B voltage input	Route B switch input (15 channels)
UNB		
A1-A15	Route A current input	circuit A outgoing lineAC current input(15 channels)
B1-B15		

AMC100-FAK48

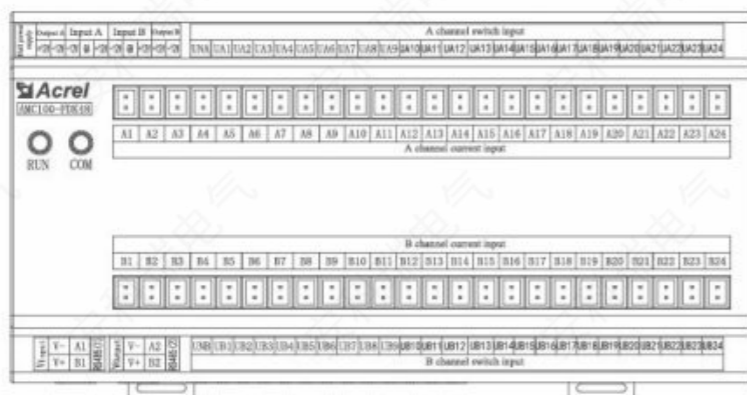

Definition	Illustrate	Remark
V+	Auxiliary power	Powered by AMC100-ZA Or powered by DC12-24V power supply
V-		
A1	RS485(1)	Connect the pre-module
B1		
A2	RS485(2)	Connect the subsequent sub-module
B2		
UA1-UA24	Route A voltage input	Route A switch input (24 channels)
UNA		
UB1-UB24	Route B voltage input	Route B switch input (24 channels)
UNB		
A1-A24	Route A current input	circuit A outgoing lineAC current input(24channels)
B1-B24		

➤ 1.11 AMC100-KA30/AMC100-KA48 Data Center Monitor Device

• Technical Parameter



Instrument model	AMC100-KA30	AMC100-KA48
Input frequency	45-65Hz AC45-65Hz	
Auxiliary power	Powered by AMC100-ZA, DC 12-24V when used alone	
Environment	Temperature	Work: -10℃ ~ 45℃ Storage: -25℃ ~ 70℃
	Humidity	Relative humidity≤95%
	elevation	≤2000m
Switch input	30 wet nodes (AC 220V)	48 wet nodes (AC 220V)
Communication	RS485/Modbus-RTU	
Installation Method	DIN35mm rail or bottom plate installation	
Protection level	IP20	
Pollution level	2	
Security	Insulation	The insulation resistance between all terminals and the conductive parts of the shell is not less than 100MΩ
	Withstand voltage	A switch value input signal//B switch value input signal//other ports meet AC2kV 1min between two, the leakage current should be less than 2mA, no breakdown or flashover phenomenon.
	Anti-static interference	Level 4
Electromagnetic compatibility	Resistance to radio frequency electromagnetic field radiation	Level 3

• Wiring

AMC100-KA30

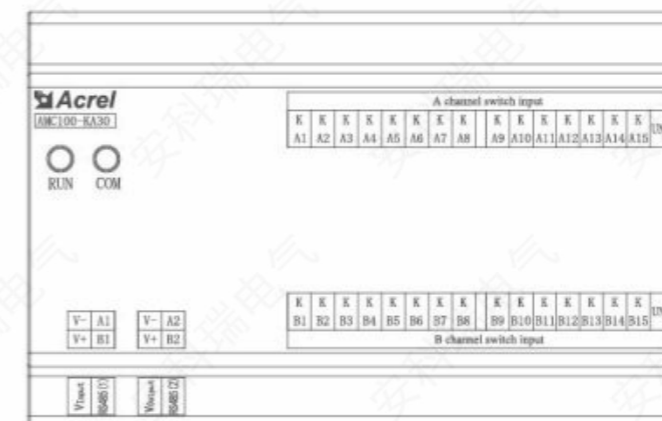

Definition	Description	Remark
V+	Auxiliary power	Powered by AMC100-ZD Or powered by DC12-24V power supply
V-		
A1	RS485(1)	Connect the pre-module
B1		
A2	RS485(2)	Connect the subsequent sub-module
B2		
KA1-KA15	A channel switch input	A channel active switch input (15 channels)
UNA		
KB1-KB15	B channel switch input	B channel active switch input (15 channels)
UNB		

AMC100-KA48

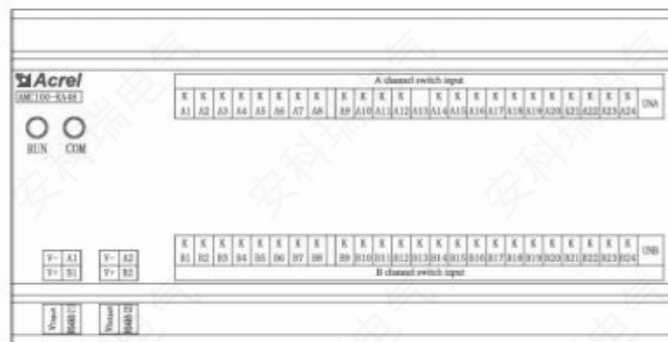

Definition	Description	Remark
V+	Auxiliary power	Powered by AMC100-ZD Or powered by DC12-24V power supply
V-		
A1	RS485(1)	Connect the pre-module
B1		
A2	RS485(2)	Connect the subsequent sub-module
B2		
KA1-KA24	A channel switch input	A channel active switch input (24 channels)
UNA		
KB1-KB24	B channel switch input	B channel active switch input (24 channels)
UNB		

➤ 1.12 AMC100-KD30/AMC100-KD48 Data Center Monitor Device

• Technical Parameter



Instrument model	AMC100-KD30	AMC100-KD48
Auxiliary power	Powered by AMC100-ZA, DC 12-24V when used alone	
Environment	Temperature	Work: -10℃~45℃ Storage: -25℃~70℃
	Humidity	Relative humidity≤95%
	elevation	≤2000m
Switch input	30 wet nodes (AC 220V)	48 wet nodes (AC 220V)
Communication	RS485/Modbus-RTU	
Installation Method	DIN35mm rail or bottom plate installation	
Protection level	IP20	
Pollution level	2	
Security	Insulation	The insulation resistance between all terminals and the conductive parts of the shell is not less than 100MΩ
	Withstand voltage	A switch value input signal//B switch value input signal//other ports meet AC2kV 1min between two, the leakage current should be less than 2mA, no breakdown or flashover phenomenon.
Electromagnetic compatibility	Anti-static interference	Level 4
	Resistance to radio frequency electromagnetic field radiation	Level 3

• Wiring

AMC100-KD30

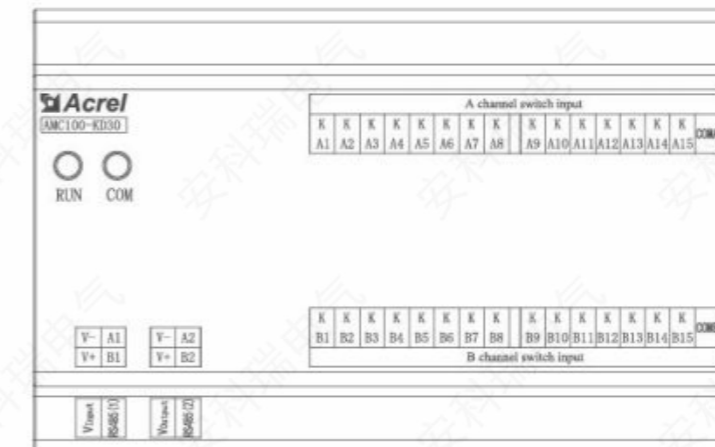

Definition	Description	Remark
V+	Auxiliary power	Powered by AMC100-ZD Or powered by DC12-24V power supply
V-		
A1	RS485(1)	Connect the pre-module
B1		

Definition	Description	Remark
A2	RS485(2)	Connect the subsequent sub-module
B2		
KA1-KA15	A channel switch input	A passive switch input (15 channels)
COMA		
KB1-KB15	B channel switch input	B passive switch input (15 channels)
COMB		

AMC100-KD48

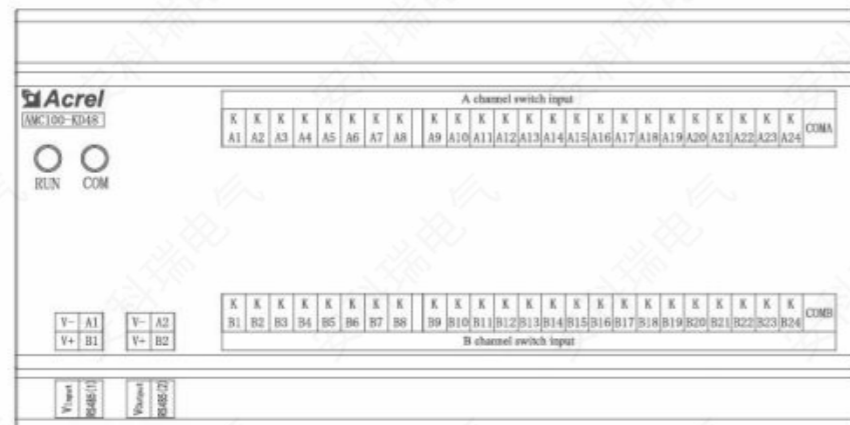

Definition	Description	Remark
V+	Auxiliary power	Powered by AMC100-ZD Or powered by DC12-24V power supply
V-		
A1	RS485(1)	Connect the pre-module
B1		
A2	RS485(2)	Connect the subsequent sub-module
B2		
KA1-KA24	A channel switch input	A passive switch input (24 channels)
COMA		
KB1-KB24	B channel switch input	B passive switch input (24 channels)
COMB		

➤ 1.13 AMC100-FT30/AMC100-FT48 Temperature measurement module

• Technical Parameter

Instrument model	AMC100-FT30	AMC100-FT48
Number of measuring channels	30 channels	48 channels
Measurement accuracy	Temperature $\pm 1^\circ\text{C}$	
Auxiliary power	Powered by AMC100-ZA, DC 12-24V when used alone	
Function	Temperature Range	$-20^\circ\text{C} \sim 150^\circ\text{C}$
	Communication	RS485/Modbus-RTU
Installation Method	DIN35mm rail or bottom plate installation	
Protection level	IP20	
Pollution level	2	
Environment	Temperature	Working temperature: $-10^\circ\text{C} \sim 45^\circ\text{C}$ Storage temperature: $-25^\circ\text{C} \sim 70^\circ\text{C}$
	humidity	Relative humidity: $\leq 95\%$
	elevation	Altitude: $\leq 2000\text{m}$
Security	Insulation	The insulation resistance between all terminals and the conductive parts of the shell is not less than $100\text{M}\Omega$
	Withstand voltage	AC2kV 1min between auxiliary power supply and temperature measurement, leakage current should be less than 2mA, no breakdown or flashover phenomenon
	Anti-static interference	Level 4
Electromagnetic compatibility	Resistance to radio frequency electromagnetic field radiation	Level 3

• Wiring

AMC100-FT30

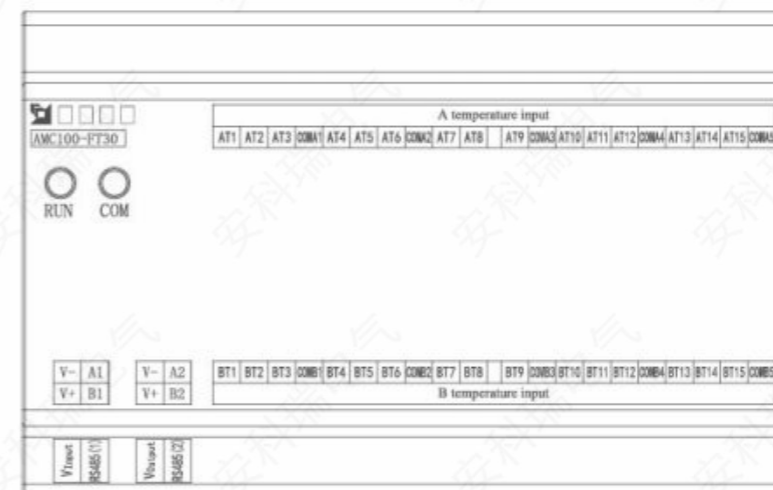

Definition	Description	Remark
V+	Auxiliary power	Powered by AMC100-ZD Or powered by DC12-24V power supply
V-		
A1	RS485(1)	Connect the pre-module
B1		
A2	RS485(2)	Connect the subsequent sub-module
B2		
AT1-AT15	Achannel temperature input	A temperature input(30 channels)
BT1-BT15	Bchannel temperature input	A temperature input(30 channels)

• Wiring

AMC100-FT48

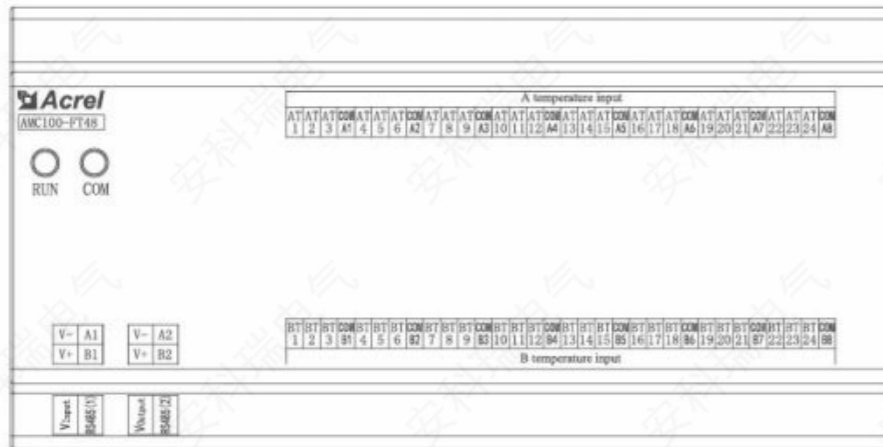

Definition	Description	Remark
V+	Auxiliary power	Powered by AMC100-ZD Or powered by DC12-24V power supply
V-		
A1	RS485(1)	Connect the pre-module
B1		
A2	RS485(2)	Connect the subsequent sub-module
B2		
AT1-AT24	A temperature input	A temperature input(24channels)
BT1-BT24	B temperature input	A temperature input(24 channels)

➤ 1.14 AMC100-ZD Data Center Monitor Device

• Technical Parameter



Instrument model		AMC100-ZD
Measured parameters		Voltage, Current, Power, Electric energy, Ambient temperature and Humidity
Bus voltage	Rated	48VDC,240VDC,336VDC
	Measuring range	±20%
	Overload	Instantaneous voltage 2 times per second
Current incoming circuit	Rated	5V (Hall sensor, ±12V powered by AMC100-ZD)
	Overload	Duration is 1.2 times, instantaneous 10 times/second
Temperature and humidity	Temperature range	-40℃ ~+99℃
	Humidity range	20%~90%
Measuring accuracy	Coil in	Voltage/current level 0.5, power/electric energy level 1
	Temperature	±1℃
	Humidity	±5%
Auxiliary supply		AMC100-ZD: Signal power (≤15W) AMC100-ZD-P24: 24V independent power supply AMC100-ZD-P220: 1、 When the constant voltage is DC 240V、 DC336V, powered by AC220V、 DC240V、 DC336V independent supply 2、 When the constant voltage is DC 48V, powered by DC48V independent supply
Environment	Temperature	Operation: -10℃ ~45℃ Storage: -25℃ ~70℃
	Humidity	Relative humidity≤95%
	Altitude	≤2000m
Switching output		4-way 3A 250VAC /3A 30VDC
Switch input		8 dry nodes
Communication		1 channel isolated RS485/Modbus-RTU to the background system 1 RS485/Modbus-RTU to touch screen 1 RS485/Modbus-RTU connection to the downstream module 1-channel Ethernet communication function is optional
Installation		Method DIN35mm rail or bottom plate installation
Protection level		IP20
Pollution level		2

Instrument model		AMC100-ZD
Security	Insulation	The insulation resistance between all terminals and the conductive parts on the shell must be at least 100MQ
	Withstand voltage	Voltage and current signal of line A // Voltage and current signal of line B // Switching output // Isolated communication port // Two of other ports should meet AC2kV for 1min, switching input and other ports should meet AC0.5kV for 1min, leakage current should be less than 2mA, no breakdown or flashover phenomenon.
Electromagnetic compatibility	Antistatic interference	Level 4
	Reactance fast transient pulse	Level 3
	Surge resistance	Level 4
	Radio frequency electromagnetic radiation	Level 3

• Wiring

AMC100-ZD/CE-P220

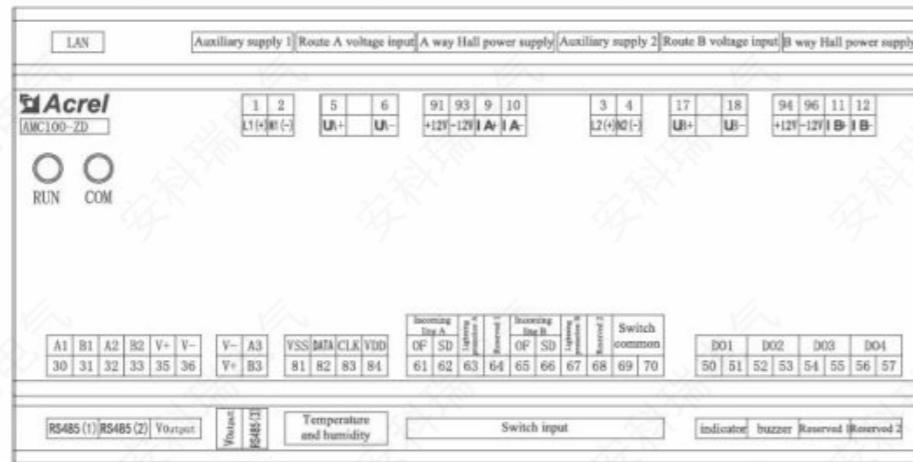

AMC100-ZD/CE-P24

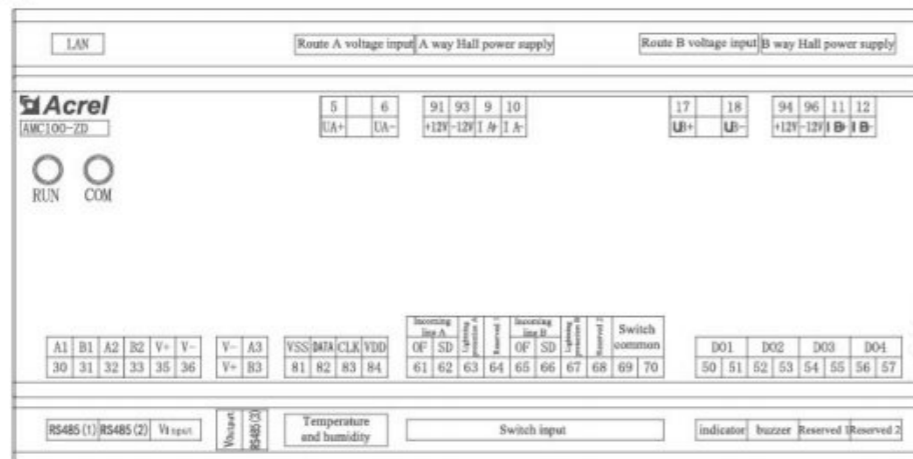

Terminal No.	Definition	Description	Description
1	L(+)	Auxiliary power	P220 used, not connected by default
2	N(-)		
3	L2(+)	Auxiliary supply2	P220 used, not connected by default
4	N2(-)		
5	UA+	Route A voltage input	Line A DC voltage input
6	UA-		
9	IA+	Route A current input	Line A incoming DC current (Hall sensor input)
10	IA-		
11	IB+	Route B current input	Line B incoming DC current (Hall sensor input)
12	IB-		
17	UB+	Route B voltage input	Line B incoming DC voltage input
18	UB-		
30	A1	RS485(1)	The first isolated communication interface, connected to the background system
31	B1		
32	A2	RS485(2)	The second channel is connected to the touch screen or RS485 hub
33	B2		
	A3	RS485(3)	The third way is connected to the downstream module
	B3		
	LAN	Ethernet	CE with Ethernet communication
35	V+	Power Output (auxiliary power input when use p24)	Power supply to AMC100-FD30/48, AMC100-FDK30/48, AMC100-KA30/48, AMC100-KD30/48, AMC100-FT30/FT48 and touch screen, this power supply prohibits external external equipment (such as indicator light, buzzer)
36	V-		
50	DO1	Switch output	Connect the buzzer
51			
52			
53			
54	DO2	Switch output	Connection indicator
55			
56	DO3	Switch output	Reserved 1
57			
61	DO4	Switch output	Reserved 2
62			
61	Incoming line A	Incoming line A	OF
62			SD
63	Lightning protection A	Switch input	Determine the SPD status of route A
64	Reserved		Reserved1
65	Incoming line B		OF+SD
66			SD
67	Lightning protection B	Switch input	Determine the SPD status of route B
68	Reserved		Reserved2
69	Common port	Switch input	Switch common
70			
81	VSS	Temperature and humidity	Connect WH-3 temperature and humidity sensor
82	DATA		
83	CLK		
84	VDD		

Terminal No.	Definition	Description	Description
91	+12V	A way Hall power supply	Power Output
93	-12V		
94	+12V	B way Hall power supply	
96	-12V		

➤ 1.15 AMC100-FD30/AMC100-FD48 Data Center Monitor Device

• Technical Parameter

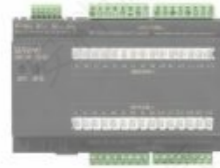

Instrument model	AMC100-FD30	AMC100-FD48
Measured parameters	Voltage, Current, Power, Electric energy	
Bus voltage	Rated	48VDC,240VDC,336VDC
	Measuring range	±20%
	Overload	Instantaneous voltage 2 times per second
Current incoming circuit	Rated	5V (Hall sensor, need external power supply ±12V or ±15V)
	Range	
	Overload	
Measuring accuracy	coil out	Voltage/current level 0.5, power/electric energy level 1
Auxiliary supply	Powered by AMC100-ZD; DC 12-24V when used alone	
Environment	Temperature	Operation: -10℃~45℃ Storage: -25℃~70℃
	Humidity	Relative humidity≤95%
	Altitude	≤2000m
Communication	RS485/Modbus-RTU	
Installation	Method DIN35mm rail or bottom plate installation	
Protection level	IP20	
Pollution level	2	
Security	Insulation	The insulation resistance between all terminals and the conductive parts on the shell must be at least 100MΩ
	Withstand voltage	Voltage and current signal of line A // Voltage and current signal of line B // The two of other ports meet AC2kV for 1min, the leakage current should be less than 2mA, and no breakdown or flashover phenomenon.
	Anti-static interference	Level 4
Electromagnetic compatibility	Radio frequency electromagnetic radiation	Level 3

• Wiring

AMC100-FD30

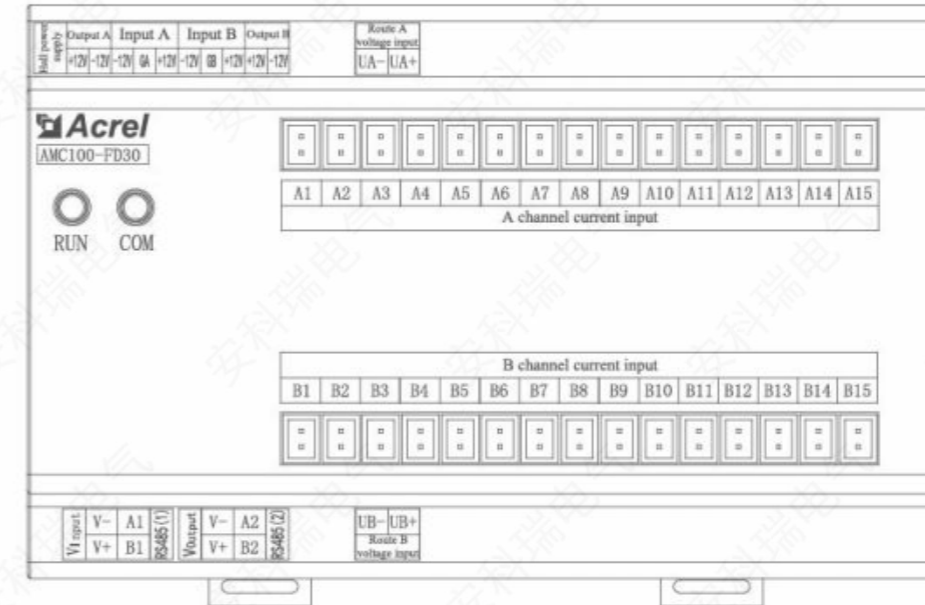

Definition	State	Remark
V+	Auxiliary supply	Powered by AMC100-ZD Or powered by DC12-24V power supply
V-		
A1	RS485 Communication (1)	Connect the pre-module
B1		
A2	RS485 Communication (2)	Connect the subsequent sub-module
B2		
UA+	Route A voltage input	Line A DC voltage input
UA-		
UB+	Route B voltage input	Line B DC voltage input
UB-		
Input A	A way Hall power supply input	±12V or ±15V switching power supply input
Output A	A way Hall power supply output	±12V or ±15V power output connected to Hall sensor
Input B	B way Hall power supply input	±12V or ±15V switching power supply input
Output B	B way Hall power supply output	±12V or ±15V power output connected to Hall sensor
A1-A15	A channel current input (15 channels)	A way outgoing DC current input(15 channels Hall sensor)
B1-B15	B channel current input (15 channels)	B way outgoing DC current input(15 channels Hall sensor)



Definition	State	Remark
V+	Auxiliary supply	Powered by AMC100-ZD Or powered by DC12-24V power supply
V-		
A1	RS485 (1)	Connect the pre-module
B1		
A2	RS485 (2)	Connect the subsequent sub-module
B2		
UA+	Route A voltage input	Line A DC voltage input
UA-		
UB+	Route B voltage input	Line B DC voltage input
UB-		
Input A	A way Hall power supply input	±12V or ±15V switching power supply input
Output A	A way Hall power supply output	±12V or ±15V power output connected to Hall sensor
Input B	B way Hall power supply input	±12V or ±15V switching power supply input
Output B	B way Hall power supply output	±12V or ±15V power output connected to Hall sensor
A1-A24	A channel current input (24 channels)	A way outgoing DC current input(24 channels Hall sensor)
B1-B24	B channel current input (24 channels)	B way outgoing DC current input(24 channels Hall sensor)

➤ 1.16 AMC100-FDK30/AMC100-FDK48 Data Center Monitor Device

• Technical Parameter



Instrument model		AMC100-FDK30	AMC100-FDK48
Measured parameters		Voltage, Current, Power, Electric energy	
Bus voltage	Rated	48VDC,240VDC,336VDC	
	Measuring range	±20%	
	Overload	Instantaneous voltage 2times per second	
Current incoming circuit	Rated	5V (Hall sensor, need external power supply ±12V or ±15V)	
	Range		
	Overload	Duration is 1.2 times, instantaneous 10 times/second	
Measuring accuracy	coil out	Voltage/current level 0.5, power/electric energy level 1	
Auxiliary supply		Powered by AMC100-ZD; DC 12-24V when used alone	
Environment	Temperature	Operation: -10℃~45℃ Storage: -25℃~70℃	
	Humidity	Relative humidity≤95%	
	Altitude	≤2000m	
Communication		RS485/Modbus-RTU	
Installation		Method DIN35mm rail or bottom plate installation	
Protection level		IP20	
Pollution level		2	
Security	Insulation	The insulation resistance between all terminals and the conductive parts on the shell must be at least 100MΩ	
	Withstand voltage	Voltage and current signal of line A // Voltage and current signal of line B // The two of other ports meet AC2kV for 1min, the leakage current should be less than 2mA, and no breakdown or flashover phenomenon.	
Electromagnetic compatibility	Anti-static interference	Level 4	
	Radio frequency electromagnetic radiation	Level 3	

• Wiring

AMC100-FDK30

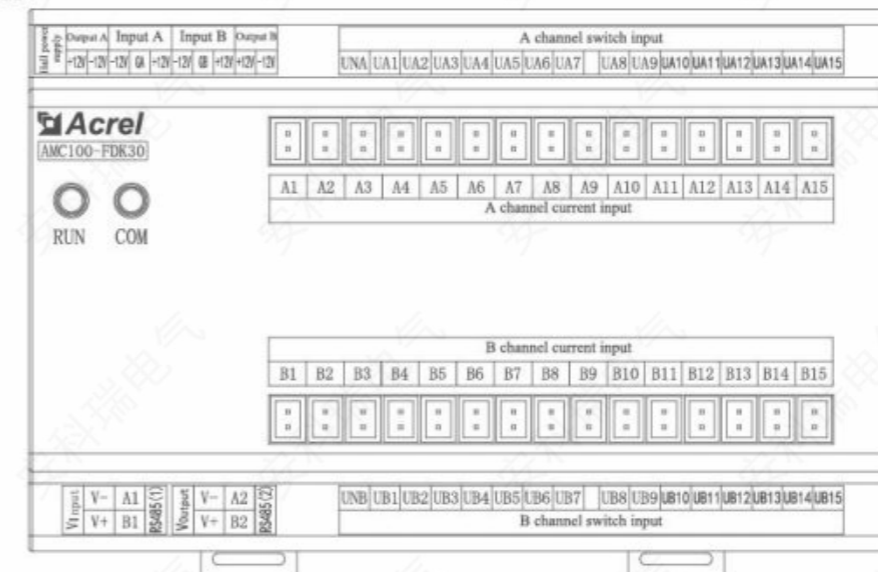

Definition	State	Remark
V+	Auxiliary supply	Powered by AMC100-ZD Or powered by DC12-24V power supply
V-		
A1	RS485 (1)	Connect the pre-module
B1		
A2	RS485 (2)	Connect the subsequent sub-module
B2		
UA+	Route A voltage input	Line A DC voltage input
UA-		
UB+	Route B voltage input	Line B DC voltage input
UB-		
Input A	A way Hall power supply input	±12V or ±15V switching power supply input
Output A	A way Hall power supply output	±12V or ±15V power output connected to Hall sensor
Input B	B way Hall power supply input	±12V or ±15V switching power supply input
Output B	B way Hall power supply output	±12V or ±15V power output connected to Hall sensor
A1-A15	A channel current input (24 channels)	A way outgoing DC current input(15 channels Hall sensor)
B1-B15	B channel current input (24 channels)	B way outgoing DC current input(15 channels Hall sensor)
UA1-UA15	A channel voltage input	A channel switch input (15 channels)
UNA		
UB1-UB15	B channel voltage input	B channel switch input (15 channels)
UNB		

Definition	State	Remark
V+	Auxiliary supply	Powered by AMC100-ZD Or powered by DC12-24V power supply
V-		
A1	RS485 (1)	Connect the pre-module
B1		
A2	RS485 (2)	Connect the subsequent sub-module
B2		
UA+	Route A voltage input	Line A DC voltage input
UA-		
UB+	Route B voltage input	Line B DC voltage input
UB-		
Input A	A way Hall power supply input	±12V or ±15V switching power supply input
Output A	A way Hall power supply output	±12V or ±15V power output connected to Hall sensor
Input B	B way Hall power supply input	±12V or ±15V switching power supply input
Output B	B way Hall power supply output	±12V or ±15V power output connected to Hall sensor
A1-A24	A channel current input	A way outgoing DC current input(24 channels)
B1-B24	B channel current input	B way outgoing DC current input(24 channels)
UA1-UA24	A channel voltage input	A channel switch input (24 channels)
UNA		
UB1-UB24	B channel voltage input	B channel switch input (24 channels)
UNB		

• Wiring

AMC100-FDK48

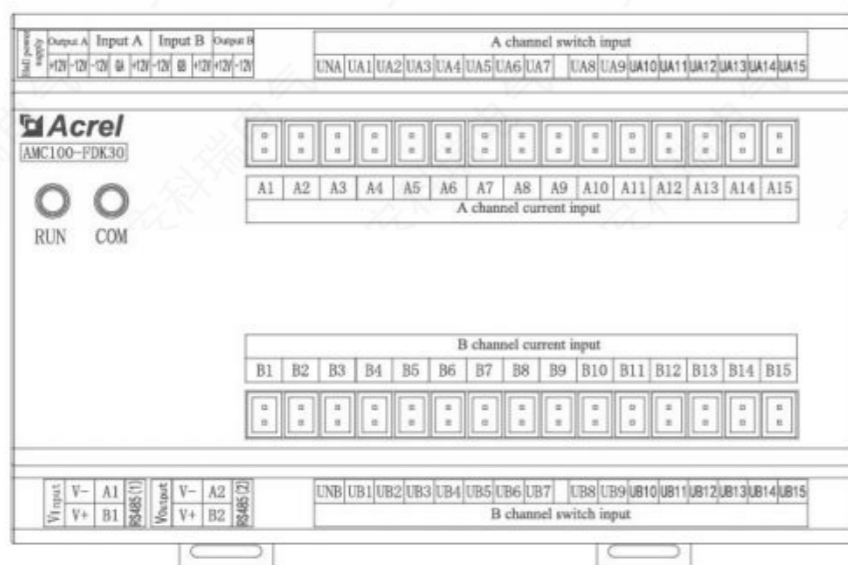

➤ 1.17 AMC100-KA30/AMC100-KA48 Data Center Monitor Device

• Technical Parameter



Instrument model	AMC100-KA30	AMC100-KA48
Auxiliary supply	Powered by AMC100-ZD; DC 12-24V when used alone	
Environment	Temperature	Operation: -10℃ ~ 45℃ Storage: -25℃ ~ 70℃
	Humidity	Relative humidity ≤ 95%
	Altitude	≤ 2000m
Switch input	30 wet nodes (48VDC, 240VDC, 336VDC)	48 wet nodes (48VDC, 240VDC, 336VDC)
Communication	RS485/Modbus-RTU	
Installation	Method DIN35mm rail or bottom plate installation	
Protection level	IP20	
Pollution level	2	

Instrument model		AMC100-KA30	AMC100-KA48
Security	Insulation	The insulation resistance between all terminals and the conductive parts on the shell must be at least 100MΩ	
	Withstand voltage	Voltage and current signal of line A // Voltage and current signal of line B // The two of other ports meet AC2kV for 1min, the leakage current should be less than 2mA, and no breakdown or flashover phenomenon.	
Electromagnetic compatibility	Anti-static interference	Level 4	
	Radio frequency electromagnetic radiation	Level 3	

• Wiring

AMC100-KA30

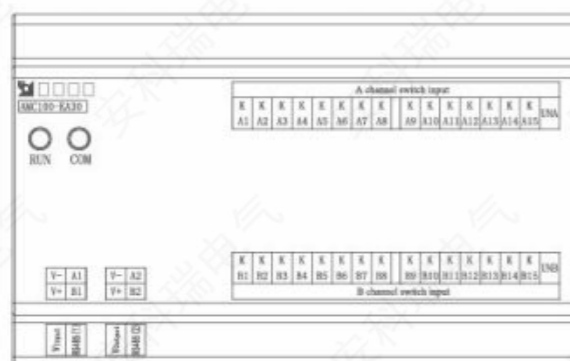

Definition	State	Remark
V+	Auxiliary supply	Powered by AMC100-ZD Or powered by DC12-24V power supply
V-		
A1	RS485(1)	Connect the pre-module
B1		
A2	RS485(2)	Connect the subsequent sub-module
B2		
KA1-KA15	A channel switch input	A channel active switch input (15 channels)
UNA		
KB1-KB15	B channel switch input	B channel active switch input (15 channels)
UNB		

AMC100-KA48

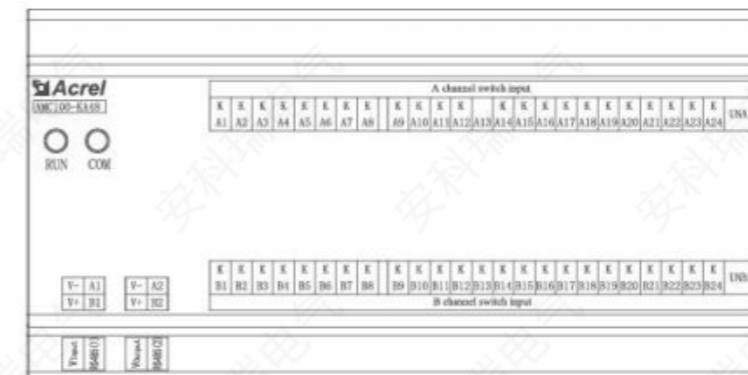

Definition	State	Remark
V+	Auxiliary supply	Powered by AMC100-ZD Or powered by DC12-24V power supply
V-		
A1	RS485(1)	Connect the pre-module
B1		
A2	RS485(2)	Connect the subsequent sub-module
B2		
KA1-KA24	A channel switch input	A channel active switch input (24 channels)
UNA		
KB1-KB24	B channel switch input	B channel active switch input (24 channels)
UNB		

➤ 1.18 AMC100-KD30/AMC100-KD48 Data Center Monitor Device

• Technical Parameter



Instrument model		AMC100-KD30	AMC100-KD48
Auxiliary supply		Powered by AMC100-ZD; DC 12-24V when used alone	
Environment	Temperature	Operation: -10℃ ~ 45℃	Storage: -25℃ ~ 70℃
	Humidity	Relative humidity ≤ 95%	
	Altitude	≤ 2000m	
Switch input		30 dry nodes	48 dry nodes
Communication		RS485/Modbus-RTU	
Installation		Method DIN35mm rail or bottom plate installation	
Protection level		IP20	
Pollution level		2	

Instrument model		AMC100-KD30	AMC100-KD48
Security	Insulation	The insulation resistance between all terminals and the conductive parts on the shell must be at least 100MΩ	
	Withstand voltage	Voltage and current signal of line A // Voltage and current signal of line B // The two of other ports meet AC2kV for 1min, the leakage current should be less than 2mA, and no breakdown or flashover phenomenon.	
Electromagnetic compatibility	Anti-static interference	Level 4	
	Radio frequency electromagnetic radiation	Level 3	

• Wiring

AMC100-KD30

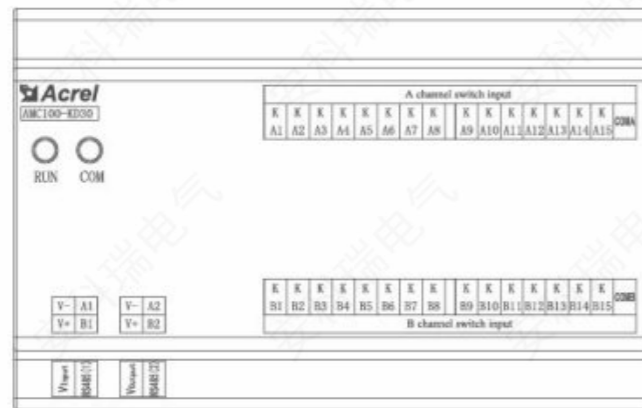

Definition	State	Remark
V+	Auxiliary supply	Powered by AMC100-ZD Or powered by DC12-24V power supply
V-		
A1	RS485(1)	Connect the pre-module
B1		
A2	RS485(2)	Connect the subsequent sub-module
B2		
KA1-KA15	A channel switch input	A passive switch input (15 channels)
COMA		
KB1-KB15	B channel switch input	B passive switch input (15 channels)
COMB		

AMC100-KD48

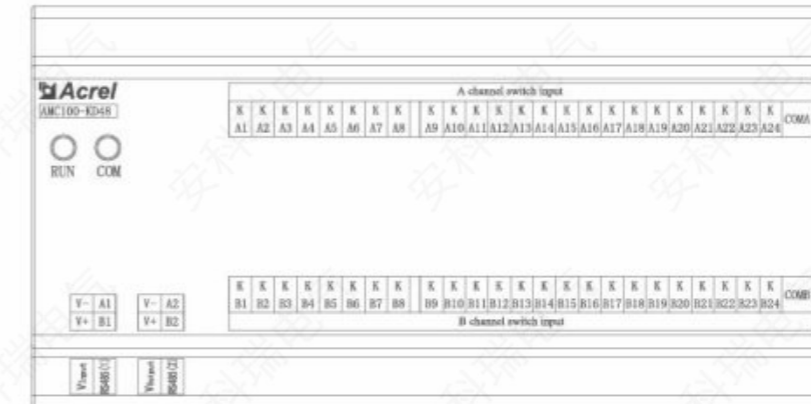

Definition	State	Remark
V+	Auxiliary supply	Powered by AMC100-ZD Or powered by DC12-24V power supply
V-		
A1	RS485(1)	Connect the pre-module
B1		
A2	RS485(2)	Connect the subsequent sub-module
B2		
KA1-KA24	A channel switch input	A passive switch input (24 channels)
COMA		
KB1-KB24	B channel switch input	B passive switch input (24 channels)
COMB		

➤ 1.19 AMC100-FT30/AMC100-FT48 Data Center Monitor Device

• Technical Parameter

Instrument model		AMC100-FT30	AMC100-FT48
Number of measuring channels		30 channels	48 channels
Measurement accuracy		Temperature±1℃	
Auxiliary supply		Powered by AMC100-ZD; DC 12-24V when used alone	
Function	Temperature measurement range	-20℃ ~ 150℃	
	Communication	RS485/Modbus-RTU	
Installation		Method DIN35mm rail or bottom plate installation	
Protection level		IP20	
Pollution level		2	

Instrument model		AMC100-FT30	AMC100-FT48
Environment	Temperature	Operation: -10℃~45℃ Storage: -25℃~70℃	
	Humidity	Relative humidity≤95%	
	Altitude	≤2000m	
Security	Insulation	The insulation resistance between all terminals and the conductive parts on the shell must be at least 100MΩ	
	Withstand voltage	Voltage and current signal of line A // Voltage and current signal of line B // The two of other ports meet AC2kV for 1min, the leakage current should be less than 2mA, and no breakdown or flashover phenomenon.	
Electromagnetic compatibility	Anti-static interference	Level 4	
	Radio frequency electromagnetic radiation	Level 3	

• Wiring

AMC100-FT30

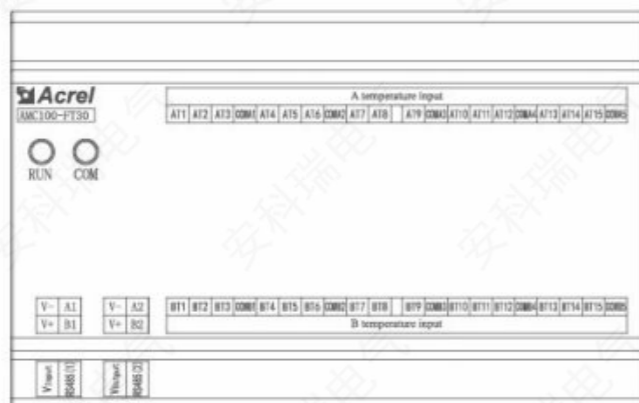

Definition	State	Remark
V+	Auxiliary power	Powered by AMC100-ZD Or powered by DC12-24V power supply
V-		
A1	RS485(1)	Connect the pre-module
B1		
A2	RS485(2)	Connect the subsequent sub-module
B2		
AT1-AT15	A channel temperature input	A temperature input(15 channels)
BT1-BT15	B channel temperature input	A temperature input(15 channels)

AMC100-FT48



Definition	State	Remark
V+	Auxiliary supply	Powered by AMC100-ZD Or powered by DC12-24V power supply
V-		
A1	RS485(1)	Connect the pre-module
B1		
A2	RS485(2)	Connect the subsequent sub-module
B2		
AT1-AT24	A temperature input	A temperature input(24 channels)
BT1-BT24	B temperature input	A temperature input(24 channels)

2.DTSD Series Multi-Circuits Energy Meter

2.1 Model Description

■ Topic module naming rule

DTSD1352 - xSyD

x-channel three-phase current circuit-
y-channel single-phase current circuit
Ankeri product series



■ Specification and model of matching transformer

Voltage specification	Instrument model	Current specification	Matching current transformer	Note
3×220/380V	DTSD1352 - xSyD	3×250A	AKH-0.66/W-20Y Class 0.2	For three phase
		3×100A	AKH-0.66/Z-15Y Class 0.2	For three phase
		1×100A	AKH-0.66/W-12Y Class 0.2	For single phase

2.2 Technical Parameter

Auxiliary power supply		AC/DC 85~265V; power consumption≤10VA;
Input signal	Frequency	45~65Hz;
	Voltage	Rated value: AC 3×220V/380V;
		overload: 1.2 times rated value (continuous) ; 2 times rated value/1 second ; power consumption: ≤ 0.5VA (per channel) ;
Current	Rated value: AC 250A、100A; (external closed port transformer)	
	overload: 1.2 times rated value (continuous) ; 10times rated value/1 second ; power consumption: ≤ 0.5VA (per channel) ;	
Measurement accuracy		Frequency 0.05Hz、voltage and current class 0.5、active energy class 1、 reactive energy class 2; 2-31 harmonic accuracy: ±1%;
Function	Pulse output	Output mode: optocoupler pulse with open collector(one out of two with active input);
	Communication	RS485 interface、Modbus-RTU protocol/QZTT 1017-2015 technical specification for China Tower smart meter; Baud rate 1200~38400;
	Switching value	Input
Output		Output mode:relay normally open contact output; Contact rating: AC 250V/3A DC 30V/3A;
Security	Power frequency withstand voltage	>AC 2kV/1min;
	Insulation resistance	Input and output end to housing;
Environment		Working temperature: -10℃~+45℃;
		Storage temperature: -40℃~+70℃;
		Relative humidity: ≤95% no condensation;
		altitude: ≤2000m;
Electromagnetic compatibility		Better than level 3;

2.3 Product Functions

Function	Description
Measurement of energy	all electrical parameters of x-channel three-phase and y-channel single-phase circuits are measured
Electrical parameters	U、I、F、P、Q、S、PF
Harmonic	2-31st voltage and current harmonic
Extreme value record	U、I、P
Alarm output	Over voltage、Over current、Phase break、DI linkage
Rate setting	4 rate time zone 14
Pulse output	Output mode: optocoupler pulse with open collector(one out of two with active input);
communication	RS485 interface、Modbus-RTU ; Baud rate 1200~38400;

Function	Description
DI	4-channels passive dry contact input,built-in power supply; 2-channels active wet node input,identify engine oil and power connection(or pulse output);
DO	Output mode:relay normally open contact output; Contact rating: AC 250V/3A DC 30V/3A;

2.4 Wiring

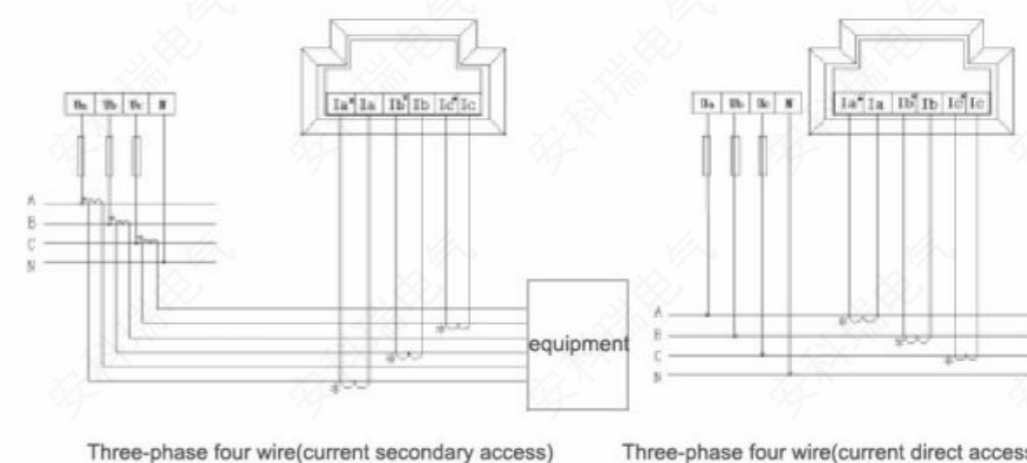
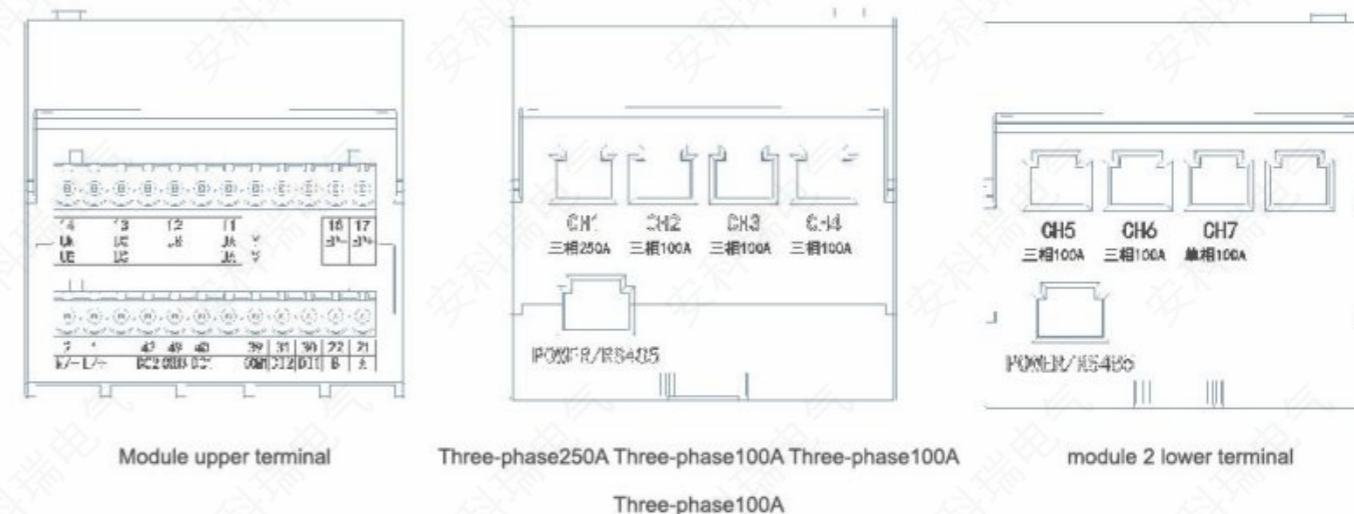

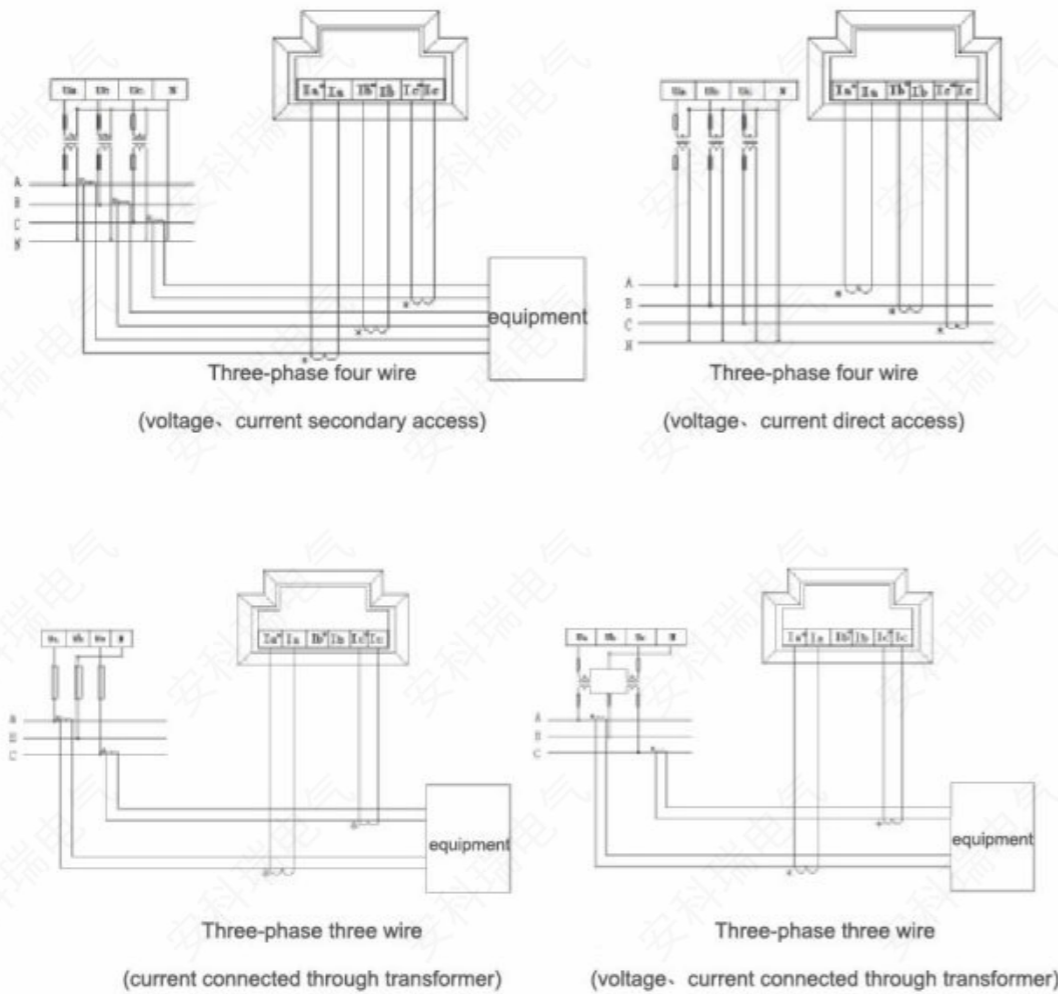

3.ADW350W Series IoT Energy Meter

3.1 Model Description

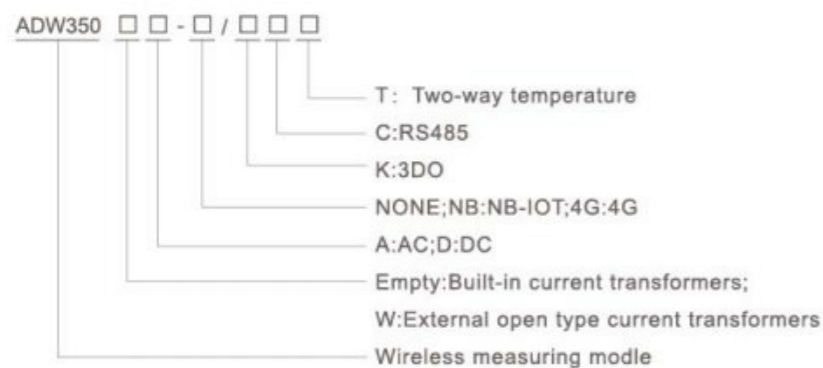

3.2 Technical Parameter

Main technical parameters

Technical parameter		Technical index
Voltage input	Rated voltage	AC: 3×57.7/100V, 3×220/380V, 3×380/660V, 3×100V, 3×380V, 3×660V;DC: 48V;
	Reference frequency	AC: 50Hz
	Consumption	<0.5VA (Each phase)
Current input	Input current	AC: 3×20(100)A; DC: 50A, 100A
	Consumption	<1VA (Each phase)
Auxiliary power	Power Supply	AC: 85~265V; DC: 48V±20%
	Power consumption	<5W
Measurement performance	Electrical parameter	Class 0.5
	Active energy accuracy	Class 1
	Temperature Range	-40 C~100 C
DO	Temperature accuracy	±2 C
	Contact Rating	5A, AC250V/DC30V
Pulse	Width of pulse	80±20ms
	Pulse constant	AC: 400imp/kWh DC: 1600imp/kWh
Communication	Wireless	2G; NB; 4G
	Infrared communication	The constant baud rate is 1200
	Interface	RS485(A, B)
	Connection mode	Shielded twisted pair conductors
	Protocol	MODBUS-RTU

Other technical parameters

Temperature range	Operating temperature	-10 C~45 C
	Storage temperature	-40 C~70 C
Humidity		≤95% (No condensation)
Altitude		<2000m

3.3 Product Functions

Function	Description
Display mode	LED
Energy metering	Active kWh (positive and negative), quadrant reactive power energy
Electrical measurement	U, I, P, Q, S, PF, F
Harmonic function	THDv, Harmonic on 2nd-31st

Function	Description
Pulse output	Active pulse output
Three-phase unbalance degree	Voltage unbalance,current unbalance
Temperature measurement	Two way temperature (Optional:T)
DI/DO	3DO (Optional:K)
External current transformer	External open type current transformer (Optional:W)
Electrical parameter	Undervoltage, undercurrent, overcurrent, underload, etc
	Infrared communication
Communication	RS485 (Optional:C)
	NB-IOT (Optional:NB)
	4G (Optional:4G)

3.4 Wiring

Interfaces

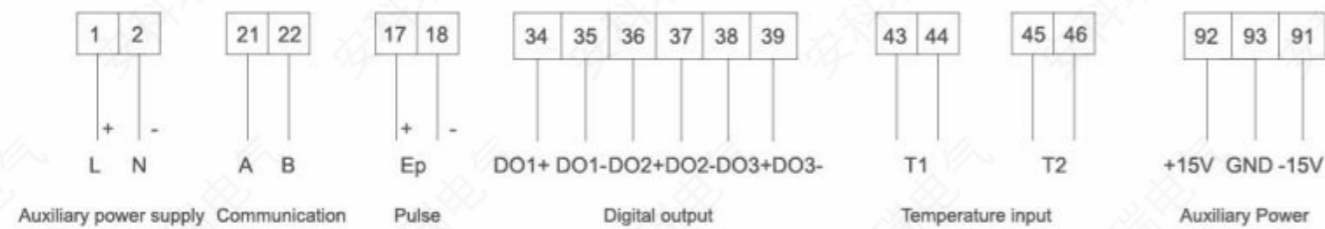

Instruction

ADW350WA

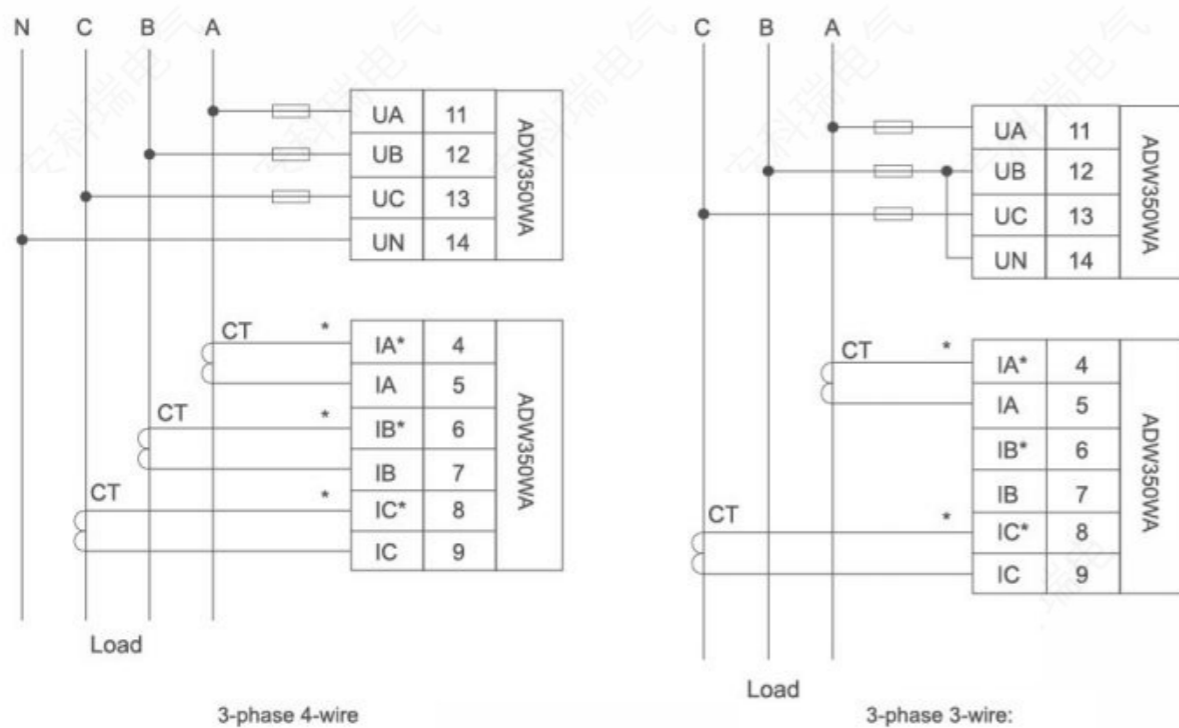

ADW350WD

Three single-phase DC can be connected.

Connection method of Hall current sensor and auxiliary power terminal:

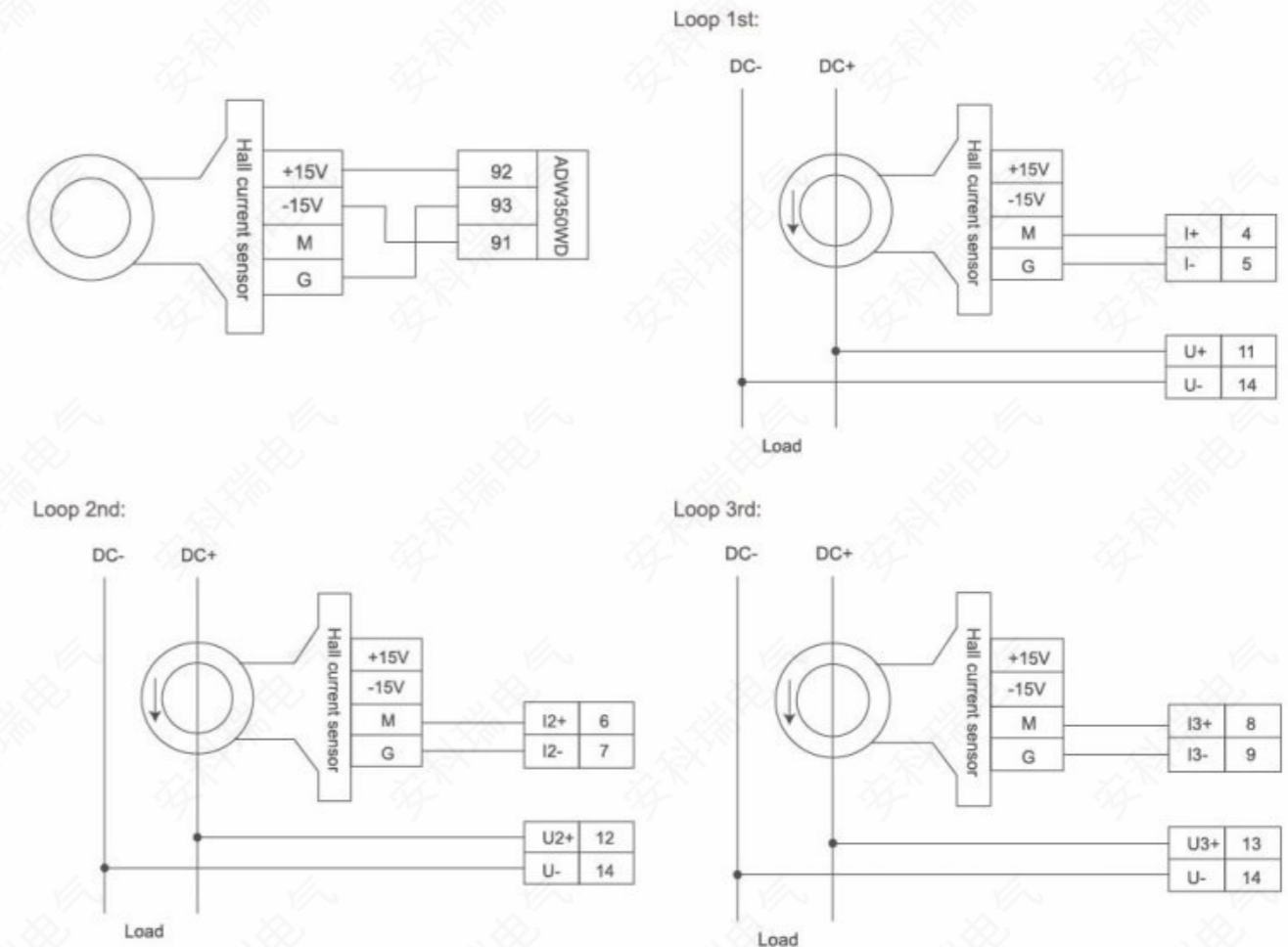

4.AMC Series Multi-Circuits DC Energy Meter

4.1 Model Description



AMC16-DETT



AMC16L-DETT

Name	Model	Instruction	Note
Base station DC energy meter	AMC16(L)-DETT	35mm din rail	L:with liquid crystal

4.2 Technical Parameter

Technical parameter		Technical index
input	DC rated voltage	1 channel: -48VDC
	DC current	6 channels hall sensors output is 5V,current ratio can be set according to the actual ratio
	Commercial power monitoring	1 channel: 0-5VDC
	Overload capacity	Voltage:1.2times continued,2 times continued 1s; Current: 1.2 times continued,10 times continued 1s.
Accuracy (superposition hall sensors)		1%In≤10%In error±2.5%; >10%In error±2%
Measurement resolution		Voltage output accuracy 0.01V; current output accuracy 0.01A; power output accuracy 0.01kw; energy output accuracy 0.01kwh.
functions	Basic function	Monitor device system time, total voltage, output total current, power, energy, each channel voltage, current, power, energy; LEDindicator display;485 communication.
	Metering function	Start current: under rated voltage, when the load current value of the meter doesn't exceed 1% of the max. current, the meter starts. Shunt running current: when there is no current in the current circuit of the meter, and 85%-125%of the rated voltage is applied on the voltage circuit, the calculator shall not have more thanone digital change.
	Alarm function	DC voltage output low alarm,DC voltage output high alarm,one power down alarm, module voltage loss alarm, metering branch error alarm, internal program error alarm, clock error alarm,memory failure alarm, AC input power failure alarm
	Timing function	support broadcast timing, could remote timing to the meterthrough RS485 communication.
	Communication	Single channel RS485, baudrate 9600bps, can be set to 1200BPS, 2400bps, 4800bps. Communication protocol: standard or customized
	Hall sensor power supply	Power supply output:+12V/100mA, -12V/50mA
	Clock accuracy	≤0.5S/d(23℃), ≤1S/d(-20℃-60℃),
	Auxiliary power supply	Voltage range -40V~-60VDC Power consumption Whole devices≤2W(no hall power supply output)
Storage		It has the storage function of historical power data and historical alarm information, and the memory is 2MB
Insulation resistance		≥40MΩ
environment	Temperature	Working : -20℃~+60℃; storage:-40℃~+70℃
	Humidity	≤98% no condensation, no corrosive gas place
	Altitude	≤4000m
Protection level		IP20
Material flame retardent		Terminal glow wire temperature 960℃±10℃ ,shell glow wire temperature 650℃±15℃

Technical parameter		Technical index
installation		Standard 35mm din rail
Lightning protection	Voltage input (differential mode)	Peak value 5kA
	Auxiliary power supply (differential mode)	Peak value 5kA

4.4 Wiring

Outline structure

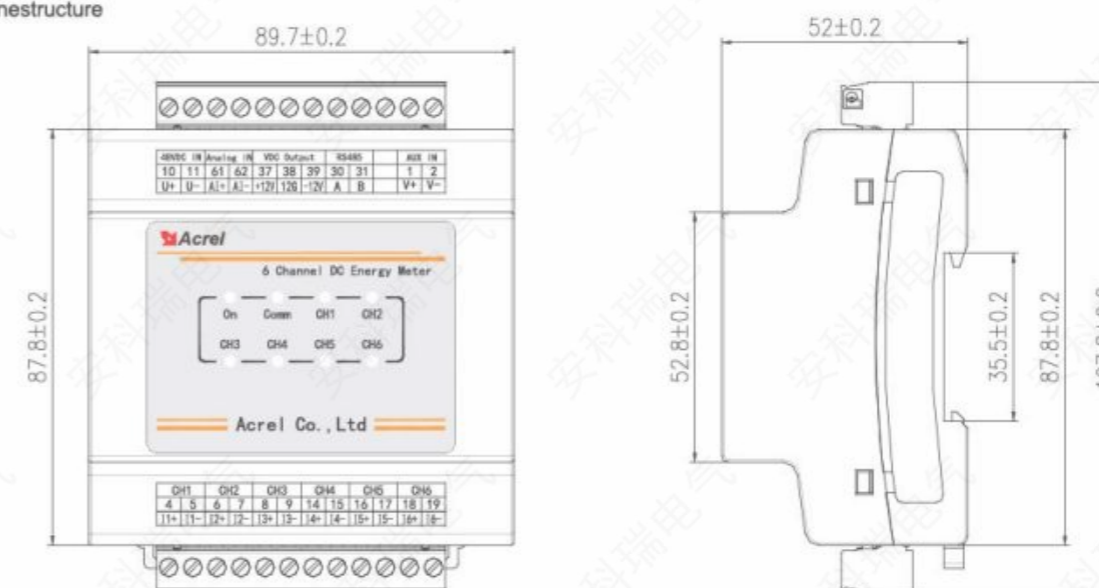

Installation wiring

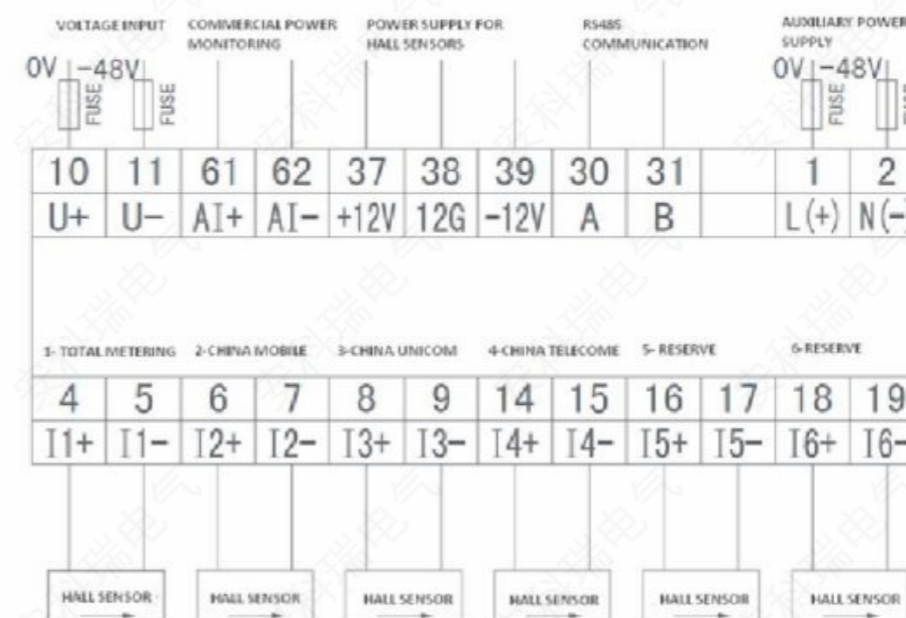

Note: arrow direction should be the same with current direction marked on the sensor.

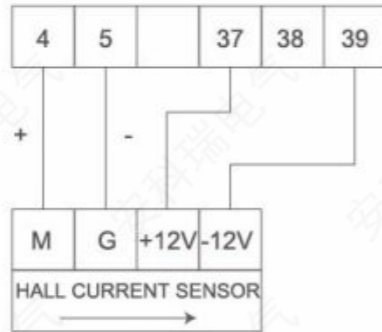

5.AMB Busway Monitoring Meter

5.1 AMB Smart AC Bus Bar Monitor

Model description



Technical parameters

Measured parameters	Voltage, current, frequency, active power, inactive power, power factor, active energy, inactive energy, 2nd-63rd harmonic, temperature, leakage	
Voltage	Rated value	3×220/380VAC
	Range	±20%
	Overloading	1.2 times than the rated voltage value continuously or 2 times than the rated voltage value instantaneously per second
Current	CT	AMB100-A: 5A/2.5mA、100A/20mA、400A/100mA、600A/100mA AMB110-A: 100A/20mA
	Range	1%~120%
	Overloading	1.2 times than the rated current value continuously or 10 times than the rated current value instantaneously per second
Input frequency	45~65Hz	
Measurement accuracy	Voltage/current : grade 0.2; active power/energy: grade 0.5; inactive power/energy: grade 1; temperature: ±1℃	

Auxiliary power supply	AMB100/110-A(W) : triggered upon receipt of request signal AMB100/110-A(W)-P1 : follow the bus bar voltage	
functions	Temperature detection	-20-150℃
	Leakage	0-1A
	Digital input	2 dry-contact inputs
	Digital output	2 relay outputs; contact capacity: 3A/30VDC,3A/250VAC
	Communication	Via RS485/Modbus-RTU or LORA antenna
Installation	Use DIN35mm rail	
Protection	IP20	
Pollution level	2	
Environment	Temperature	Working temperature: -10-45℃ Storage temperature: -25-70℃
	humidity	Relative humidity: ≤95%
	altitude	Altitude: ≤2000m
Safety	Insulation	The minimum insulation resistance between all terminals and conductive components of the shell is 100MΩ.
	Withstanding voltage	When a voltage of 2kV AC is applied between the voltage/ current input, relay output, RS485 port, auxiliary power supply and digital inputs, the leakage shall be less than 2mA and no breakdown or flashover shall occur in 1min.
Electromagnetic immunity	Electrostatic discharge immunity	Class 4
	Radio frequency electromagnetic immunity	Class 3
	Transient immunity burst	Class 4
	Surge immunity	Class 4

Functions

Model	Standard functions	Optional functions
AMB100-A	(1) Measurement of all electrical parameters of three-phase AC circuit, 2nd to 63rd harmonic measurements, 1 leakage current, 8-way temperature, 1-way humidity, maximum demand measurement, neutral current, potential difference measurement between the null line and the ground line, 2 digital inputs, 2 digital outputs	/W(LORA)

Model	Standard functions	Optional functions
AMB100-A-P1	(2)Measurement of all electrical parameters of three-phase AC circuit, 2nd to 63rd harmonic measurements, 1 leakage current, 8-way temperature, 1-wayhumidity,maximum demand measurement, neutral current measurement, 2 digital inputs, 2 digital outputs, discrete auxiliary power supply	/W(LORA)
AMB110-A	(1)Measurement of all electrical parameters of three-phase AC circuit, 2nd to 63rdharmonic measurements, 1 leakage current, 8-way temperature, 1-way humidity,maximum demand measurement, neutral current measurement, potential difference measurement between the null line and the groundline, 2 digital inputs, 2 digital outputs	
AMB110-A-P1	(2)Measurement of all electrical parameters of three-phase AC circuit, 2nd to 63rdharmonic measurements, 1 leakage current, 8-way temperature, 1-wayhumidity, maximum demand measurement, neutral current measurement, 2 digital inputs, 2 digital outputs, discrete auxiliary power supply	

Note 1. AMB: bus bar series; 100: for Start box; 110: forPlug in box; A: for alternating-current system; P1: discrete auxiliary power supply

Note 2. For optional LORA function, an external magnetic antenna is equipped. The standard length is 2 m.

Note 3. For temperature sensors, there are two round-hole variants, namely 12mm-hole variant and 8mm-hole variant, and one 6mm-cylindrical variant. Each variant includes yellow, green, red and black sensors.

• Wiring

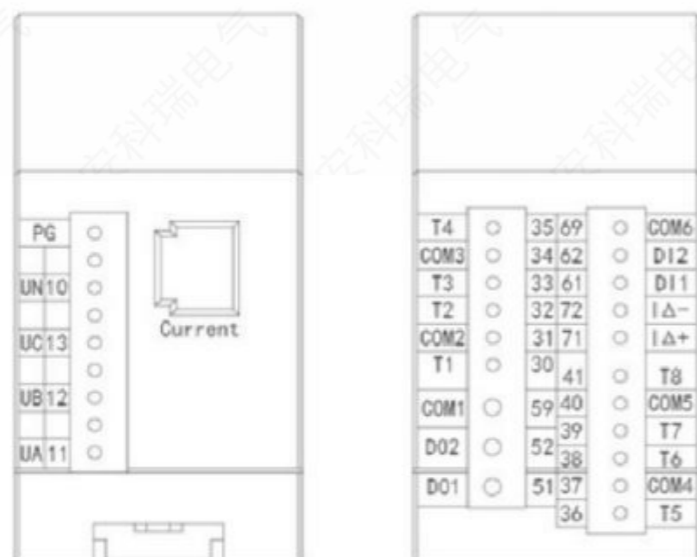

AMB1X0-A(W) Triggered upon Receipt of Request Signal

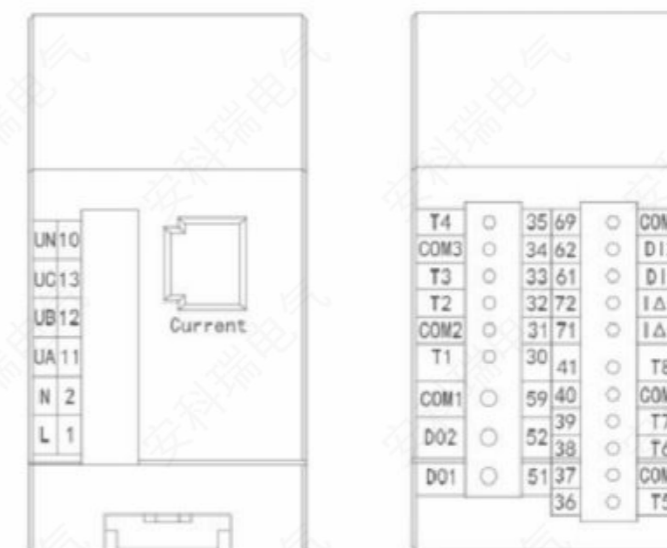

AMB1X0-A(W)-P1 Discrete Auxiliary Power Supply

Voltage and currentconnection

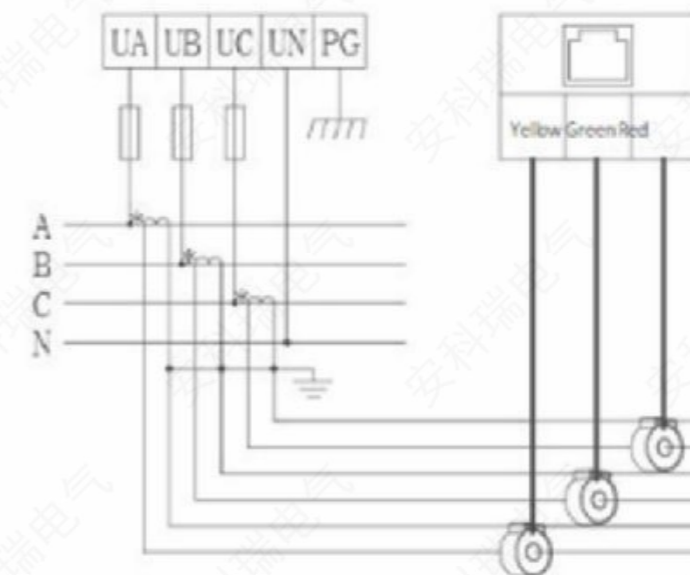

Current >630A

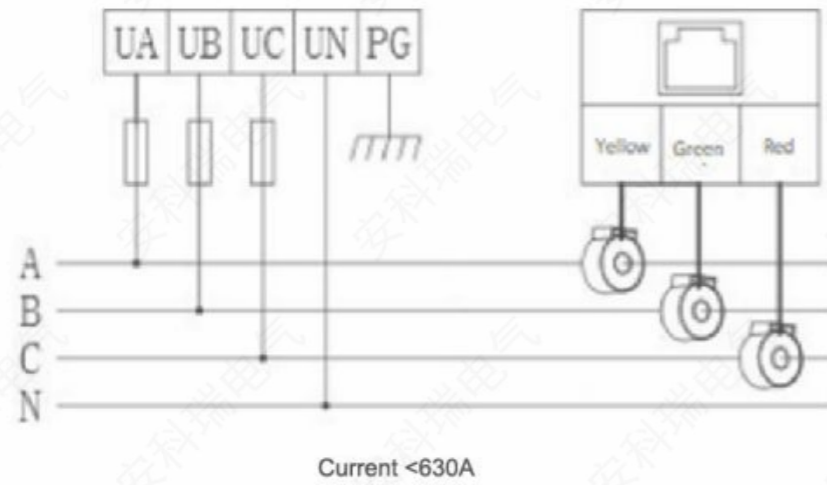

Mains and auxiliary power supply connections

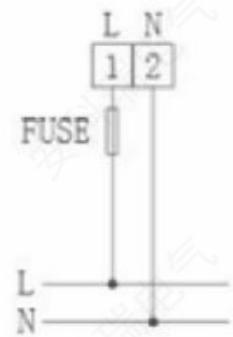

AMB1X0-A(W)-P1
Auxiliary Power Supply

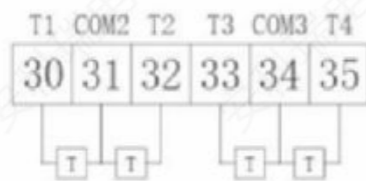

Temperature input1



Temperature input2

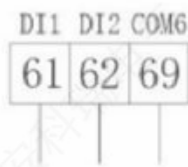

Digital inputRelay outputLeakageinput

Mains and auxiliary power supply connections



RJ45 connector



T568A

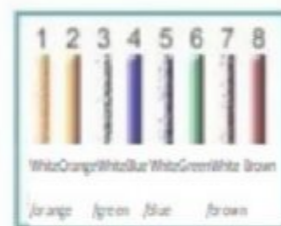

T568B

Note: It is not available if LORA is activated.

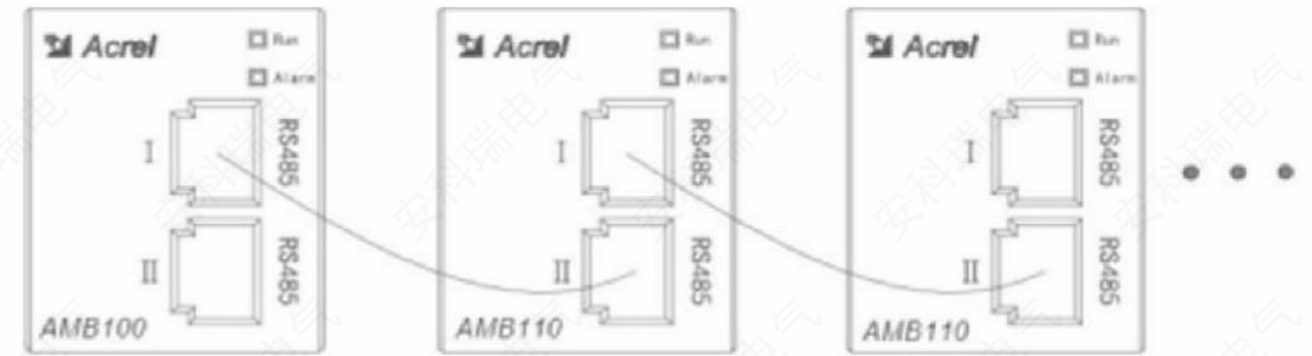

Connection of Detection Modules

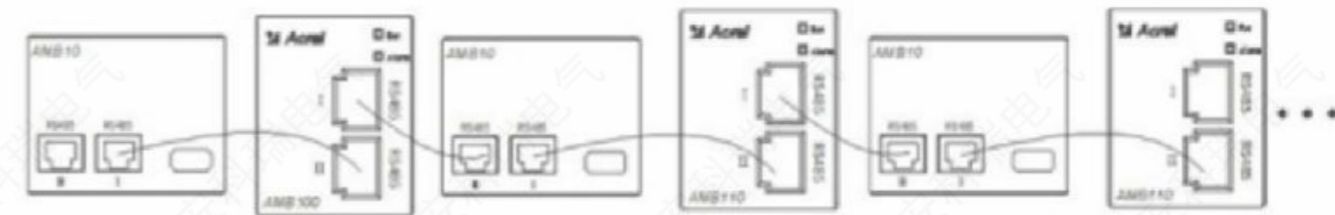

Connection of Detection Module with Display

5.2 AMB Smart DC Bus Bar Monitor

Model description



Technical parameters

Technical parameters	AMB100-D-□/AMB110-D-□	
Measured parameters	Voltage, current, power, electric energy, on/off status	
Voltage	Rated value	48VDC, 240VDC, 336VDC
	Range	±20%
	Overloading	1.2 times than the rated voltage value continuously or 2 times than the rated voltage value instantaneously per second

Measurement accuracy	Voltage/current: grade 0.5; power/energy: grade 1.0	
Auxiliary power supply	AMB100/110-D(W): triggered upon receipt of request signal AMB100/110-D(W)-P1: follow the bus bar voltage	
functions	Temperature detection	-20-150 C
	Leakage	5VDC, 3 leakage inputs
	Digital input	4 dry-contact inputs
	Digital output	2 relay outputs; contact capacity: 3A/30VDC,3A/250VDC
	Communication	Via RS485/Modbus-RTU or LORA antenna
Installation	Use DIN35mm rail	
Protection	IP20	
Pollution level	2	
Environment	Temperature	Working temperature: -10-45 C Storage temperature: -25-70 C
	humidity	Relative humidity: ≤95%
	altitude	Altitude: ≤2000m
Safety	Insulation	The minimum insulation resistance between all terminals and conductive components of the shell is 100MΩ.
	Withstanding voltage	When a voltage of 2kV AC is applied between the voltage/ current input, relay output, RS485 port, auxiliary power supply and digital inputs, the leakage shall be less than 2mA and no breakdown or flashover shall occur in 1min.
Electromagnetic immunity	Electrostatic discharge immunity	Class 4
	Radio frequency electromagnetic immunity	Class 3
	Transient burst immunity	Class 4
	Surge immunity	Class 4

Note 1. Hall leakage transducer must be equipped with auxiliary power supply.
Note 2. The electric energy is added in 5A/5V. Operate the touch screen to view the electric energy at the primary side, if desired.

• Functions

Model	Standard functions	Optional functions
AMB 100-D	Measurement of all electrical parameters of one DC circuit, 3 leakage current, 4-way temperature, 1-way humidity,4 digital inputs,2 digital outputs, discrete auxiliary power supply	W(LORA)
AMB 100-D-P1		
AMB 110-D	Measurement of all electrical parameters of three DC circuit,3 leakage current, 4-way temperature , 1 humidity detection, 4 digital inputs, 2digital outputs, discrete auxiliary power supply	
AMB 110-D-P1		

Note 1. AMB=bus bar series; 100= for Start box; 110= for Plug in box; D= for direct-current system; P1= discrete auxiliary power supply
Note 2. For optional LORA function, an external magnetic antenna is equipped. The standard length is 2 m.
Note 3. The standard version is equipped with 1m-length harness to which maximum 3 Hall transducers are connected. The yellow wire must be used if just one Hall transducer is connected.
Note 4. For temperature sensors, there are two round-hole variants, namely 12mm-hole variant and 8mm-hole variant, and one 6mm-cylindrical variant. Each variant includes yellow, green, red and black sensors.

• Wiring



AMB1X0-D(W) Triggered upon Receipt of Request Signal

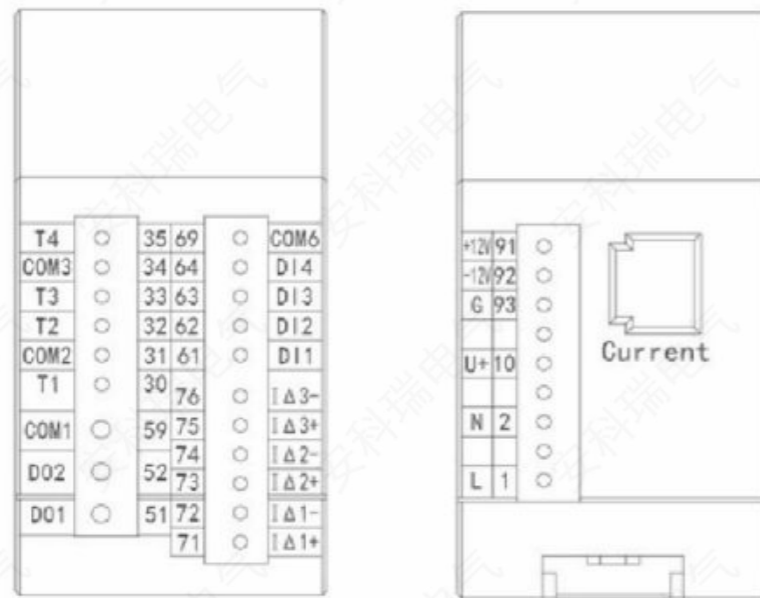

AMB1X0-D(W)-P1 Discrete Auxiliary Power Supply

Voltage, current and transducer connection

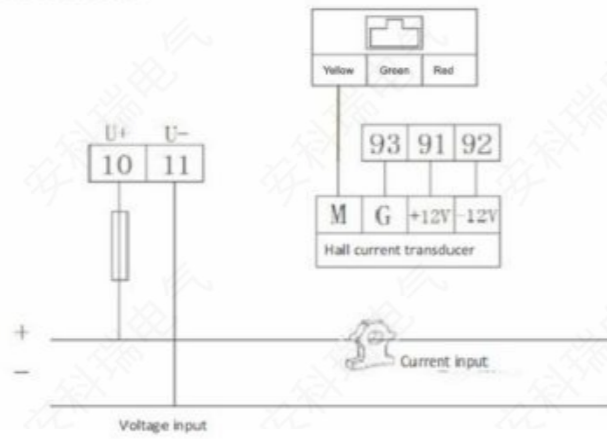

Current >630A

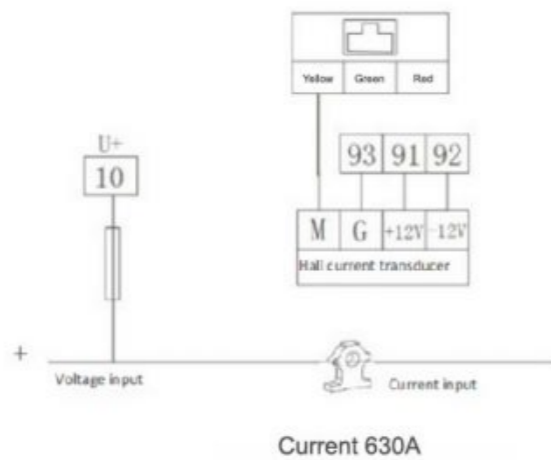

Current 630A

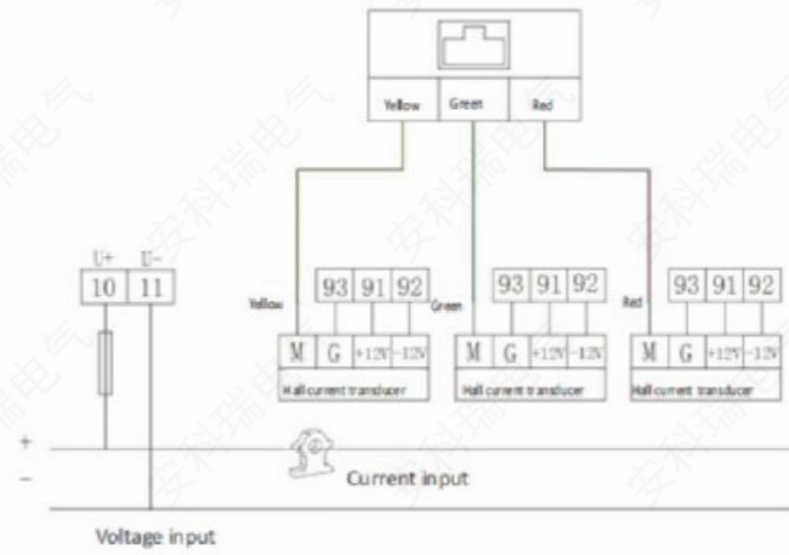

Current >630A

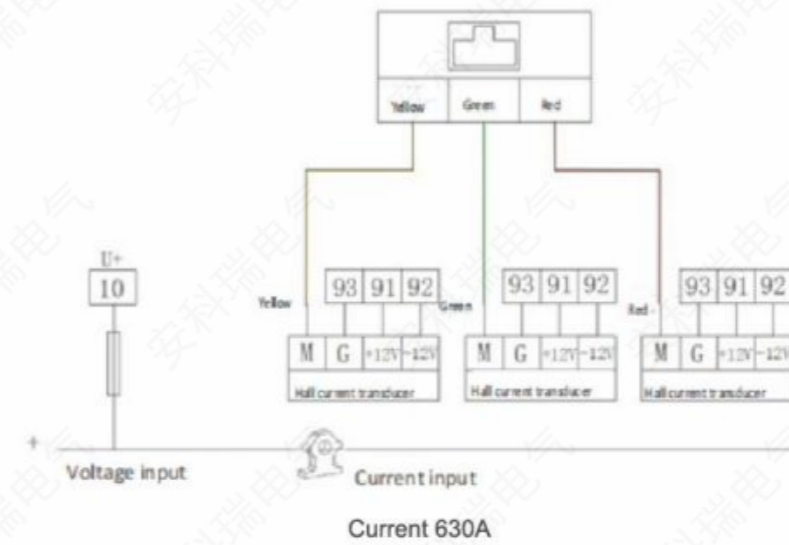

Current 630A

Mains and auxiliary power supply connections

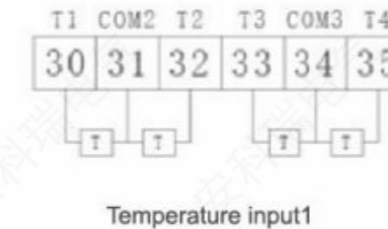
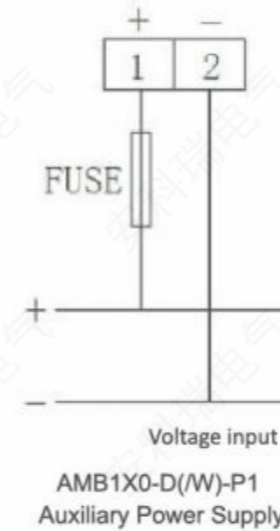

Temperature input1

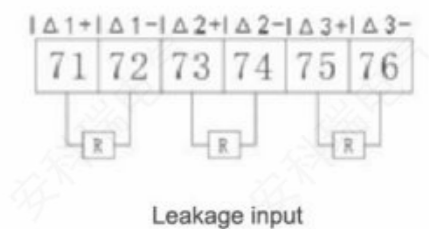

Leakage input

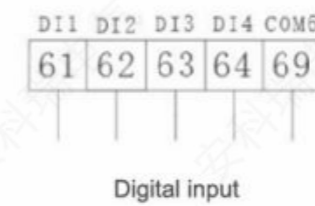

Digital input



Relay output

Network shielded wireconnection



Note: It is not available if LORA is activated.

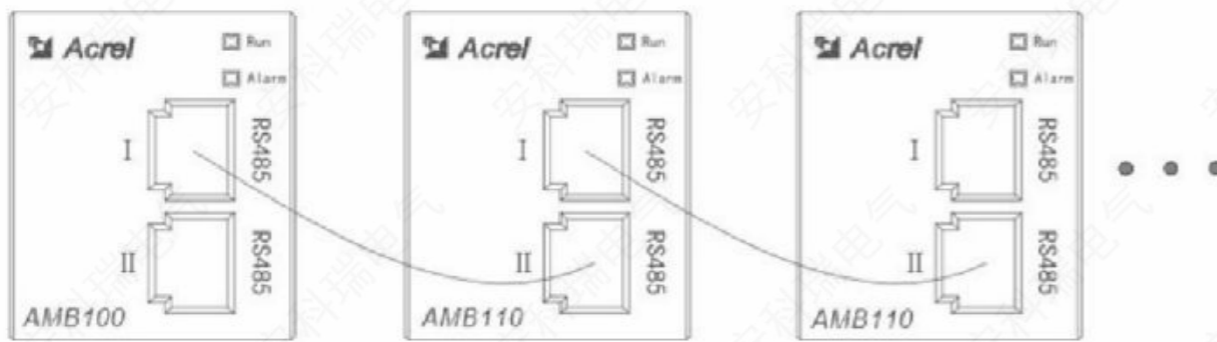

Connection of Detection Modules

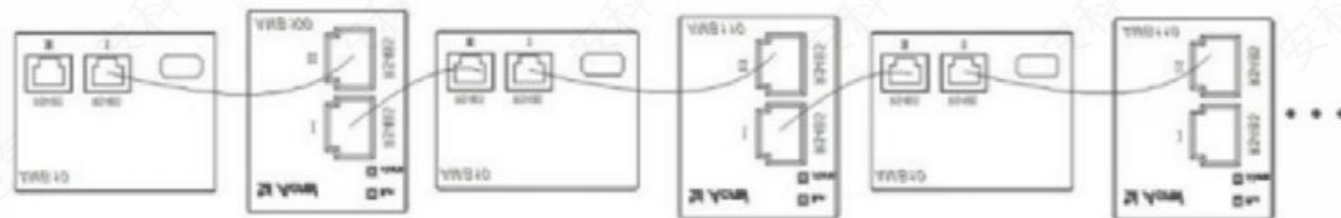

Connection of Detection Module with Display

5.3 AMB infrared temperature measurement solution

Model description



Technical parameters

Technical parameter	AMB300-Z	AMB300-D4	AMB300-D1
Function	Measuring range temperature, display the highest 4 channels, humidity (optional)	4-way temperature	1-way temperature and humidity (optional)
Range	Temperature -10℃~150℃, humidity 0%RH-95%RH	Temperature-10℃~150℃	1-way temperature and humidity (optional)
Accuracy	(-10℃~85℃) temperature ±3℃, (85℃~150℃) temperature ±5℃, humidity ±5%RH	(-10℃~85℃) temperature ±3℃, (85℃~150℃) temperature ±5℃	(-10℃~85℃) temperature ±3℃, (85℃~150℃) temperature ±5℃, humidity ±5%RH
NTC temperature measurement range (optional)	Temperature-10℃~150℃	Temperature-10℃~150℃	Temperature-10℃~150℃
Auxiliary supply	Power supplied by AMB310	Power supplied by AMB310	Power supplied by AMB310
Communication	Two channels	Two channels	Two channels
Protection level	IP51	IP51	IP51
Pollution level	2	2	2
Electromagnetic compatibility	Antistatic interference	Level 4	Level 4
	Anti-electric fast transient burst	Level 4	Level 4

Technical parameter		AMB300-Z	AMB300-D4	AMB300-D1
Environment	Whole machine temperature	Working: -10℃~45℃ Store: -40℃~70℃	Working: -10℃~45℃ Store: -40℃~70℃	Working: -10℃~45℃ Store: -40℃~70℃
	Humidity	Relative humidity ≤95%, no condensation	Relative humidity ≤95%, no condensation	Relative humidity ≤95%, no condensation
	Altitude	Altitude	Altitude	Altitude

• Functions

Name	Model	Functions description
Infrared temperature measurement module	AMB300-Z	Two-bus communication, real-time online detection of a large-scale array temperature. It needs to be used with an infrared temperature measurement collector and powered by the collector.
	AMB300-Z-T	Two-bus communication, real-time online detection of a large-range array temperature, and an external NTC temperature measurement. It needs to be used with an infrared temperature measurement collector and powered by the collector.
	AMB300-Z-H	Two-bus communication, real-time online detection of a large-scale array temperature and humidity at the connector. It needs to be used with an infrared temperature measurement collector and powered by the collector.
	AMB300-Z-TH	Two-bus communication, real-time online detection of a large-range array temperature, humidity at the connector, and an external NTC temperature measurement. It needs to be used with an infrared temperature measurement collector and powered by the collector.
	AMB300-D1	Two-bus communication, real-time online detection of a single point temperature in a small range. It needs to be used with an infrared temperature measurement collector and powered by the collector.
	AMB300-D1-T	Two-bus communication, real-time online detection of a single point temperature in a small range, and an external NTC temperature measurement. It needs to be used with an infrared temperature measurement collector and powered by the collector.
	AMB300-D1-H	Two-bus communication, real-time online detection of a small range of single-point temperature and humidity at the connector. It needs to be used with an infrared temperature measurement collector and powered by the collector.

Name	Model	Functions description
Infrared temperature measurement module	AMB300-D1-TH	Two-bus communication, real-time online detection of a single point temperature in a small range, humidity at the connector, and an external NTC temperature measurement. It needs to be used with an infrared temperature measurement collector and powered by the collector.
	AMB300-D4/15	Two-bus communication, real-time online detection of 4 small-range single-point temperatures, each probe is 15mm apart. It needs to be used with an infrared temperature measurement collector and powered by the collector.
	AMB300-D4/15-T	Two-bus communication, real-time online detection of 4 small-range single-point temperatures, each probe has a distance of 15mm, and an external NTC temperature measurement. It needs to be used with an infrared temperature measurement collector and powered by the collector.
Infrared temperature measurement collector	AMB310	2-channel of downlink two-bus communication, up to 200 infrared temperature measurement modules can be collected, 2-channel of RS485 communication to the monitoring system or touch screen, DC 24V power supply.

• Wiring

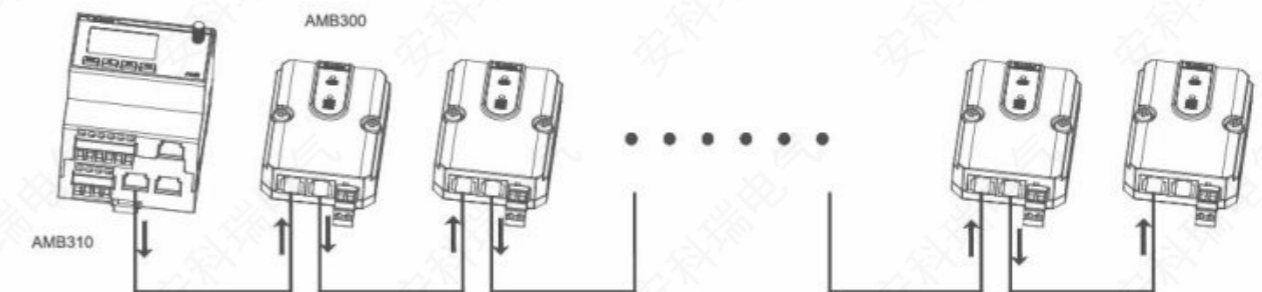

The arrow in the figure above indicates the direction of 24-30V signal output. The communication port needs to use a SHIELDED RJ45 cable. The left RJ45 port on the AMB300 module in the figure above is the signal incoming port, and the right RJ45 port is the signal outgoing port, which is used to connect to the incoming port of the next module.